

U16F -36kg

Compétiteurs/Competitors

#	Nom/Name	Grade	Club	1	2	3	G/W	Pts	Pos
1	TREMBLAY Aimy	2k	QC/Chicoutimi	XX	10	10	2	20	1
2	BODRYAKOVA Rita	3k	ON/Taifu		XX		0	0	3
3	PARK Harper	3k	BC/Peak		10	XX	1	10	2

Matches/Matches

Match	Blanc/White			Bleu/Blue	Rés/Res	Tmp/Tim	Code
D-149	TREMBLAY Aimy	1	2	BODRYAKOVA Rita	10 - 0	1:39	IPO
C-174	TREMBLAY Aimy	1	3	PARK Harper	10 - 0	2:33	WIP
C-177	BODRYAKOVA Rita	2	3	PARK Harper	0 - 10	1:40	WIP

Résultats/Results

Pos	Nom/Name
1	TREMBLAY Aimy, QC/Chicoutimi
2	PARK Harper, BC/Peak

U16F -44kg

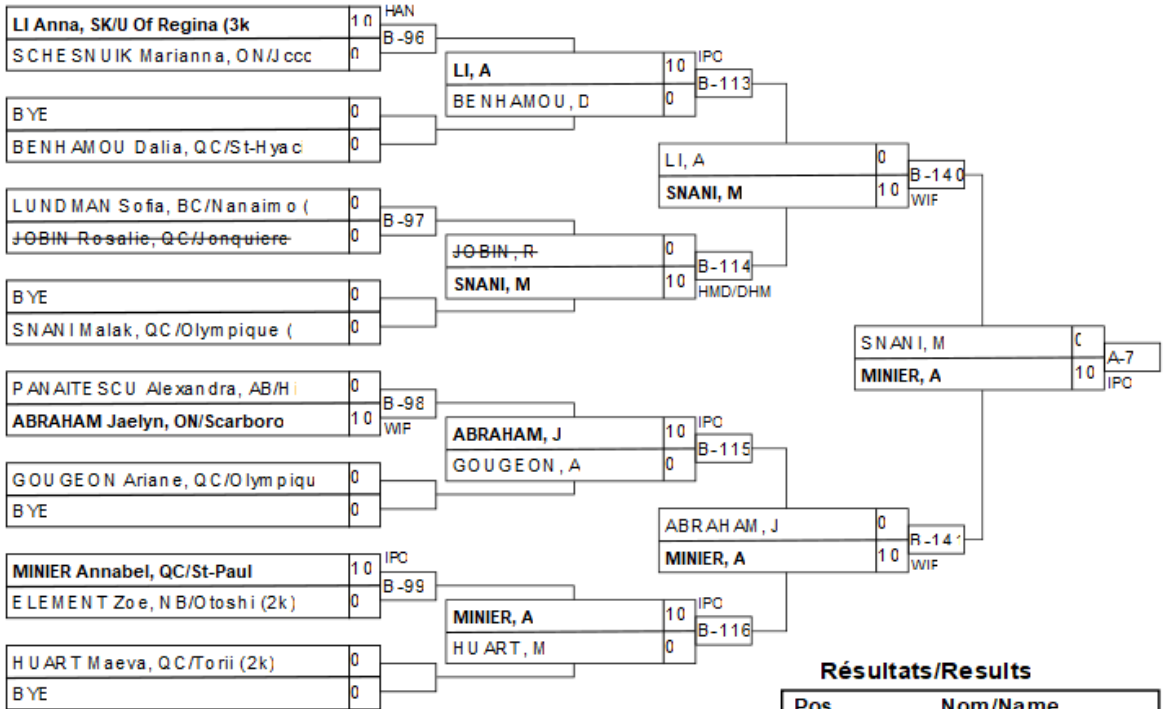

Résultats/Results

Pos	Nom/Name
1	MINIER Annabel, QC/St-Paul
2	SNANI Malak, QC/Olympique
3	LI Anna, SK/U Of Regina
3	ELEMENT Zoe, NB/Otoshi

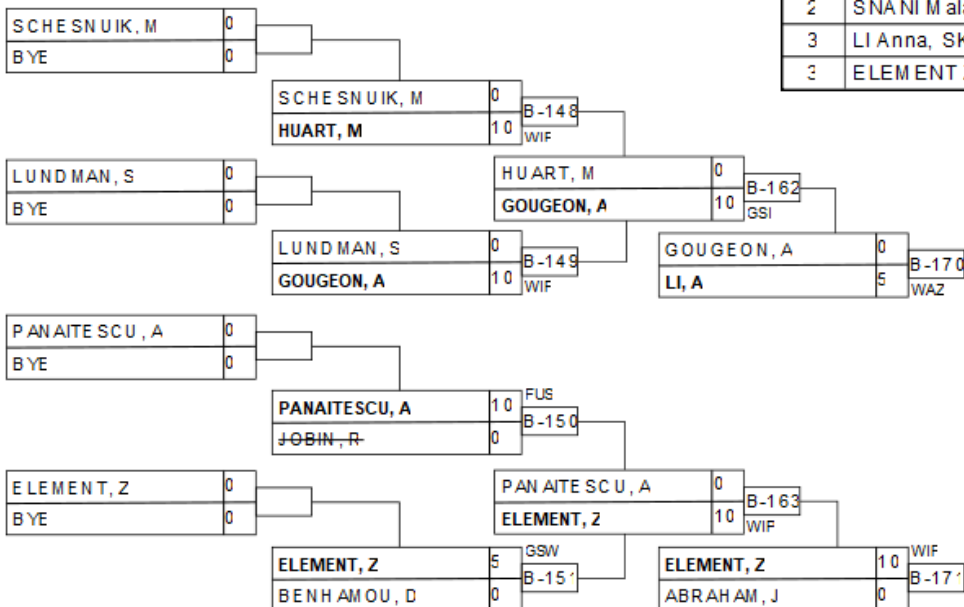

U16F -48kg

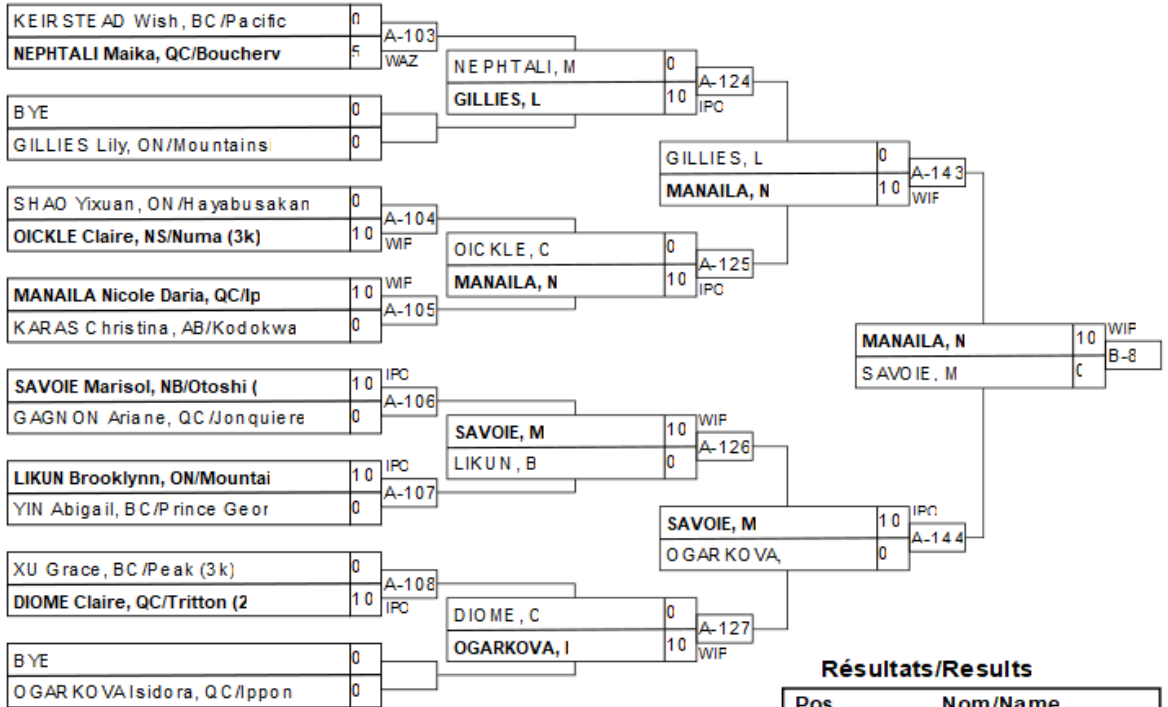

Résultats/Results

Pos	Nom/Name
1	MANAILA Nicole Daria, QC
2	SAVOIE Marisol, NB/Otosh
3	KARAS Christina, AB/Kodo
3	OGARKOVA Isidora, QC/Ippon

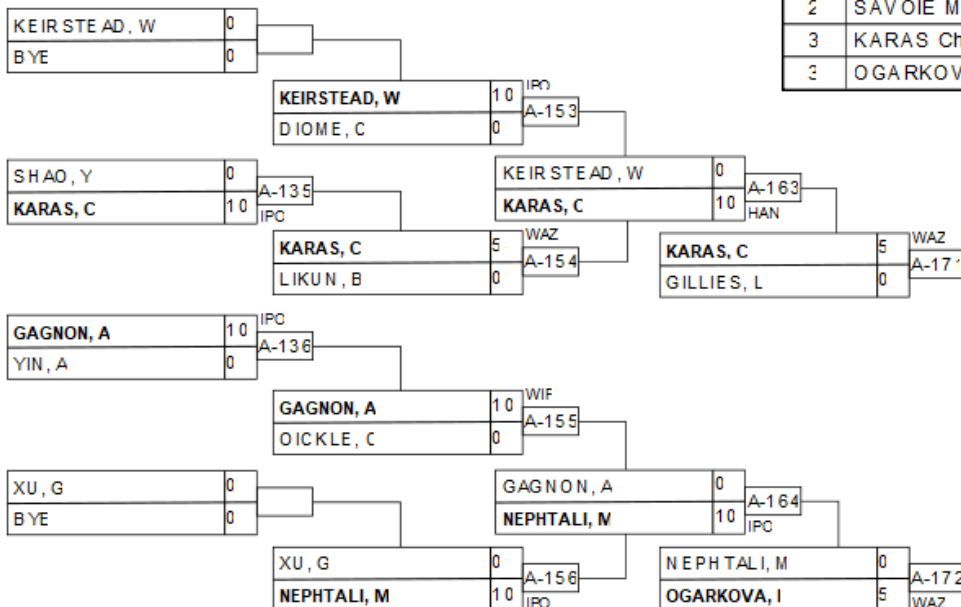

U16F -52kg

KHOSAH ars aya, BC/Abbots for	0	C-97 WIF	OU DOVIKINE, K	0	C-111 GSW	LAVOIE, C	5
OU DOVIKINE Ksenia, ON/Taifu	10			LAVOIE, C			0
LAVOIE Camille, QC/Jonquier	0		LAVOIE, C	0	C-132 WIF	TRITTON, E	10
BYE	0			TRITTON, E			0
TRITTON Emma, QC/Tritton (1	0		TRITTON, E	10	C-112 IPC	LAW, E	0
BYE	0			LAW, E			0
LAW Eze, QC/Perrot Shima (3	10	C-98 IPC	LAW, E	0	C-133 WIF	O'GORMAN, N	10
AIDI Kenza, AB/Ni Ten Judo	0			O'GORMAN, N			0
ATALLAH Catherine, QC/Budok	0		ATALLAH, C	0	C-113 WIF	O'GORMAN, N	0
BYE	0			O'GORMAN, N			10
KHAZHEVSKAIA Evelina, BC/K	0	C-99 IPC	O'GORMAN, N	10	C-134 IPC	AU, M	10
O'GORMAN Niamh, MB/Nakamura	10			AU, M			0
AU Megan, BC/Peak (2k)	5	C-100 WAZ	AU, M	10	C-114 WIF	SULLIVAN, R	0
WESTFALL Sadie, ON/Upper Ca	0			SULLIVAN, R			0
BYE	0		SULLIVAN, R	0	C-168 IPO	LAVOIE, C	10
SULLIVAN Rose, QC/Sakura (3	0			ATALLAH, C			0

Résultats/Results

Pos	Nom/Name
1	TRITTON Emma, QC/Tritton
2	AU Megan, BC/Peak (2k)
3	LAVOIE Camille, QC/Jonqu
3	OU DOVIKINE Ksenia, ON/Ta

KHOSAH	0		KHOSAH	0	C-144 IPO	SULLIVAN, R	10
BYE	0			SULLIVAN, R			0
BYE	0		SULLIVAN, R	10	C-158 IPC	ATALLAH, C	0
AIDI, K	0			ATALLAH, C			0
AIDI, K	0	C-145 IPO	SULLIVAN, R	0	C-168 IPO	LAVOIE, C	10
ATALLAH, C	10			LAVOIE, C			0
BYE	0		KHAZHEVSKAIA, E	0	C-146 IPO	LAW, E	10
KHAZHEVSKAIA, E	0			LAW, E			0
WESTFALL, S	0		LAW, E	0	C-159 GSW	OU DOVIKINE, K	5
BYE	0			OU DOVIKINE, K			0
WESTFALL, S	0	C-147 HAN	OU DOVIKINE, K	10	C-169 IPO	O'GORMAN, N	0
OU DOVIKINE, K	10			O'GORMAN, N			0

U16F -57kg

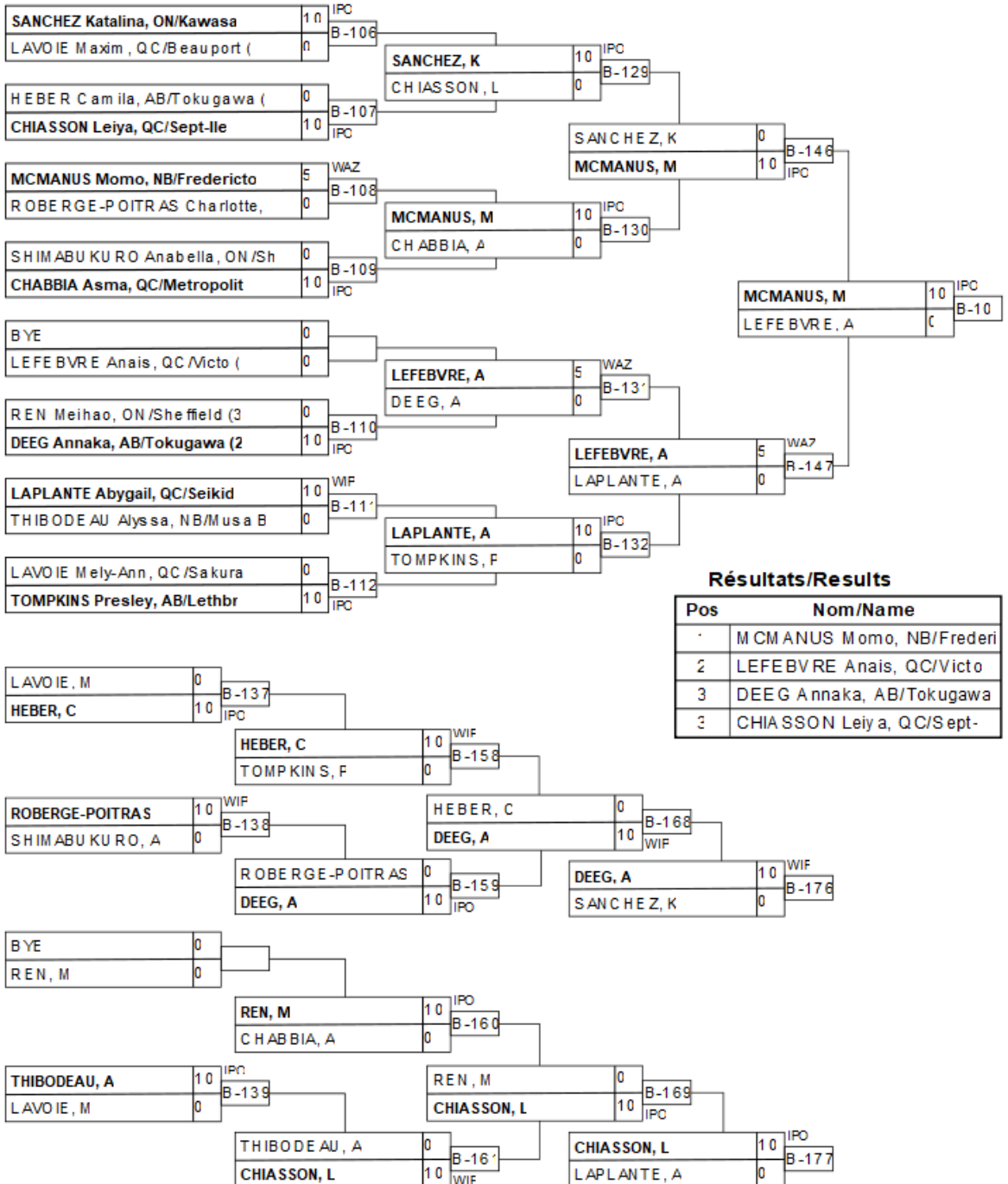

Résultats/Results

Pos	Nom/Name
1	MCMANUS Momo, NB/Frederi
2	LEFEBVRE Anais, QC/Victo
3	DEEG Annaka, AB/Tokugawa
3	CHIASSON Leiya, QC/Sept-

U16F -63kg

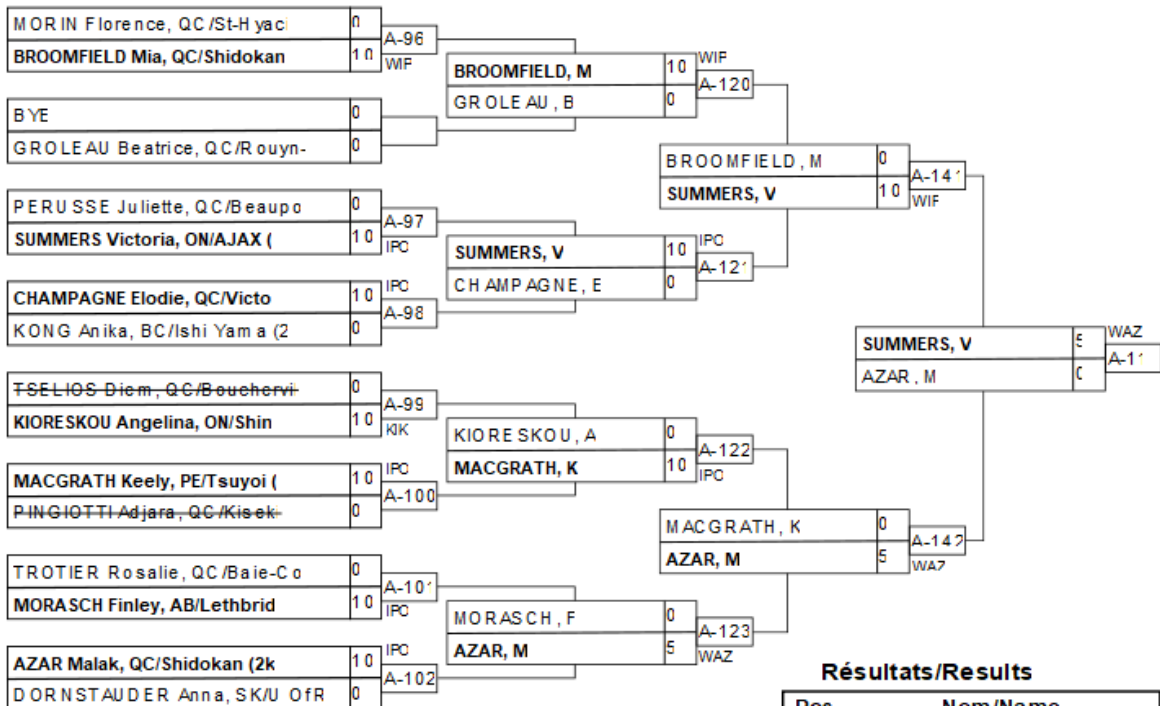

Résultats/Results

Pos	Nom/Name
1	SUMMERS Victoria, ON/AJA
2	AZAR Malak, QC/Shidokan
3	KIORESKOU Angelina, ON/S
3	MACGRATH Keely, PE/Tsuyoi

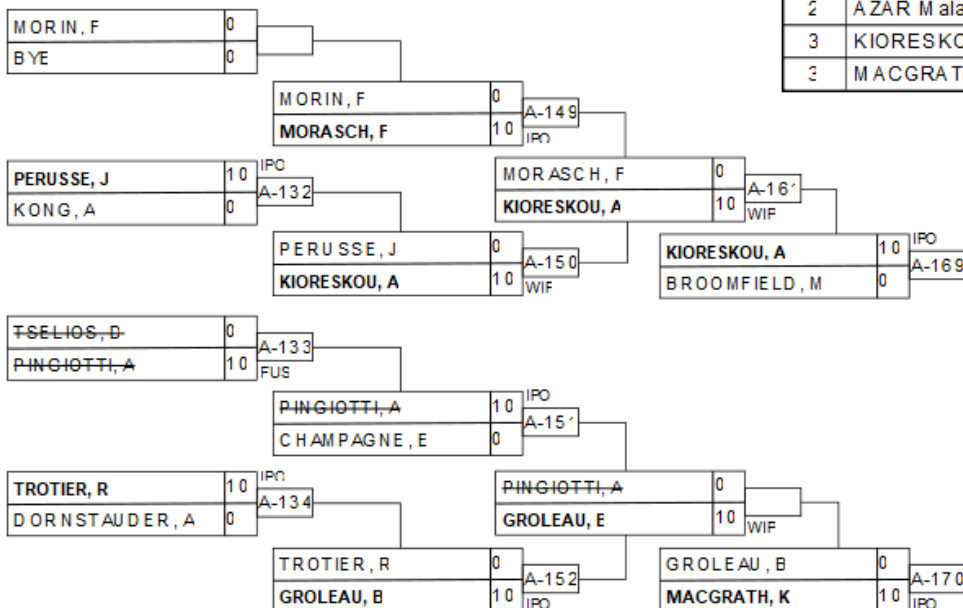

U16F -70kg

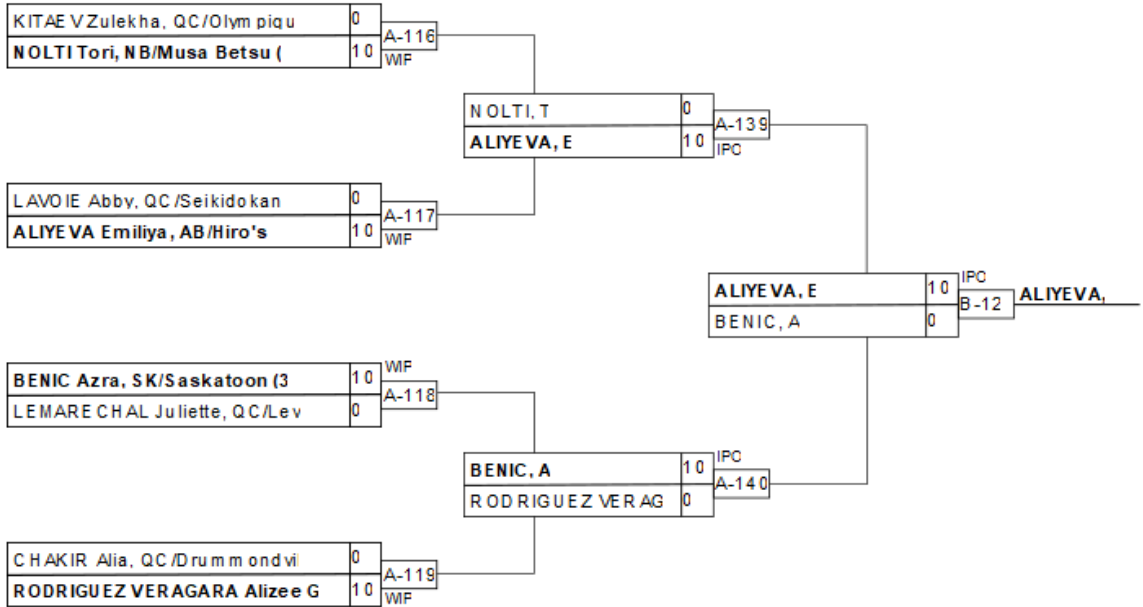

Résultats/Results

Pos	Nom/Name
1	ALIYEVA Emiliya, A B/Hiro
2	BENIC Azra, SK/Saskatoon
3	LEMARECHAL Juliette, QC/
3	LAVOIE Abby, QC/S eikidok

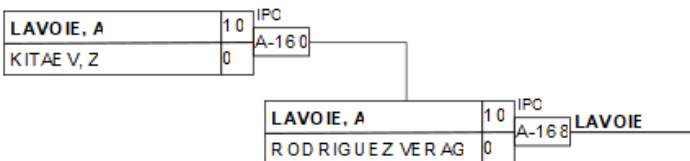
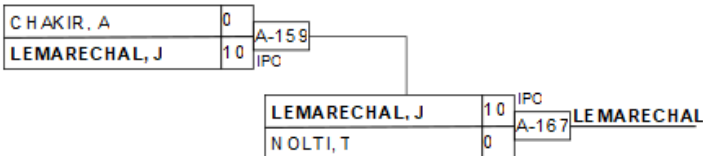

U16F +70kg

Compétiteurs/Competitors

#	Nom/Name	Grade	Club	1	2	3	4	G/W	Pts	Pos
1	PROULX OLSON Brooke	2k	QC/Perrot Shima	XX			10	1	10	3
2	COUTHON Paola	3k	QC/Jonquiere	5	XX		10	2	15	2
3	FOWLER Alicia	3k	NB/Tani Koi	10	10	XX	10	3	30	1
4	LECLERC Sophie	2k	QC/To Haku kan				XX	0	0	4

Matches/Matches

Match	Blanc/White			Bleu/Blue	Rés/Res	Tmp/Tim	Code
C-138	PROULX OLSON Brooke	1	2	COUTHON Paola	0 - 5	3:00	WAZ
C-139	FOWLER Alicia	3	4	LECLERC Sophie	10 - 0	0:11	IPO
C-154	PROULX OLSON Brooke	1	3	FOWLER Alicia	0 - 10	1:10	WIP
C-155	COUTHON Paola	2	4	LECLERC Sophie	10 - 0	0:49	IPO
C-164	PROULX OLSON Brooke	1	4	LECLERC Sophie	10 - 0	0:00	FUS
A-13	COUTHON Paola	2	3	FOWLER Alicia	0 - 10	1:07	IPO

Résultats/Results

Pos	Nom/Name
1	FOWLER Alicia, NB/Tani Koi
2	COUTHON Paola, QC/Jonquiere
3	PROULX OLSON Brooke, QC/Perrot Shima

U16M -38kg

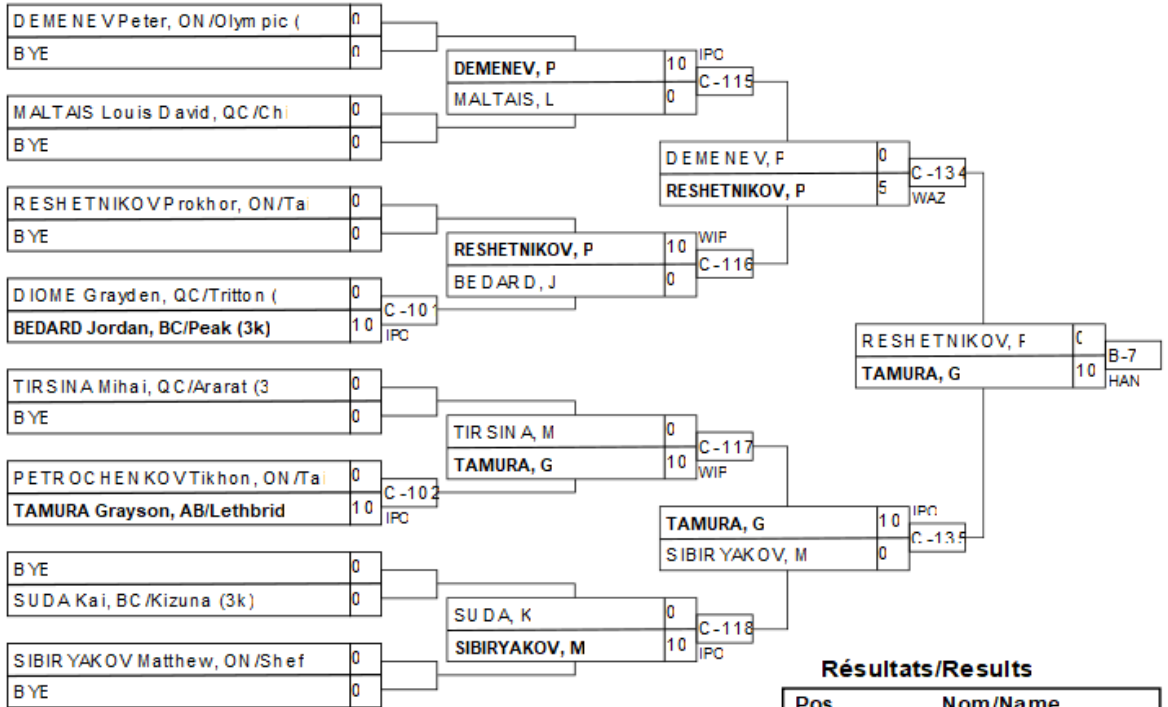

Résultats/Results

Pos	Nom/Name
1	TAMURA Grayson, AB/Lethbr
2	RESHETNIKOV Prokhor, ON/
3	DEME NE V Peter, ON/Olympi
3	MALTAIS Louis David, QC/

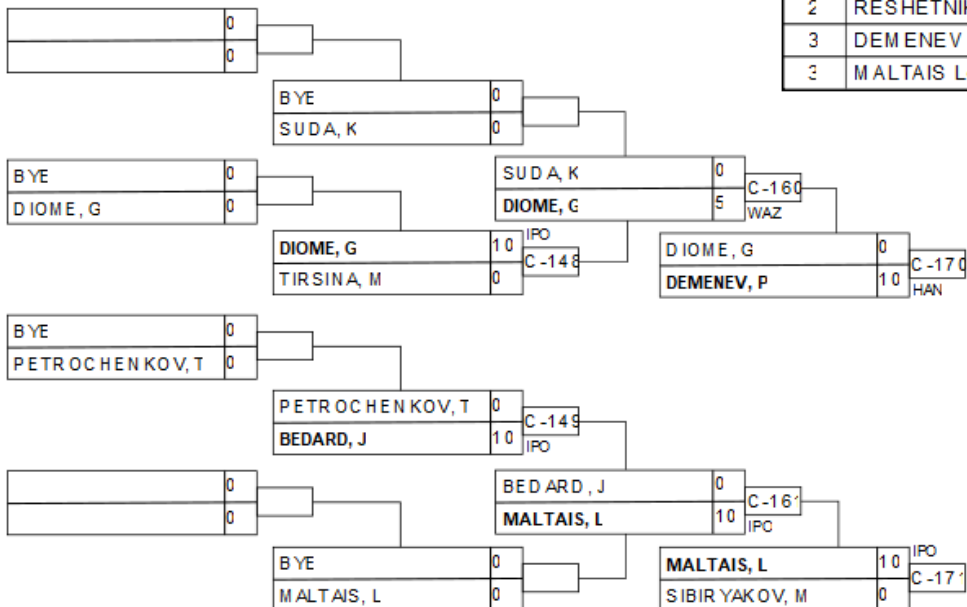

U16M -42kg

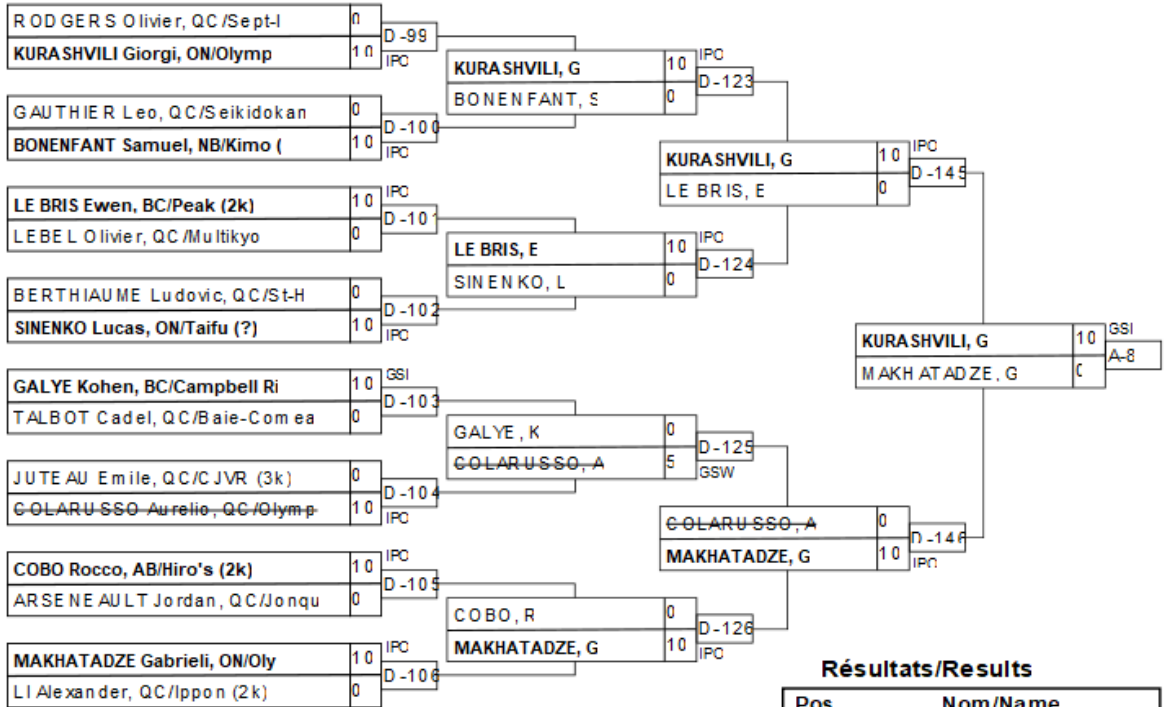

Résultats/Results

Pos	Nom/Name
1	KURASHVILI Giorgi, ON/OI
2	MAKHATADZE Gabrieli, ON/OI
3	LE BRIS Ewen, BC/Peak (2)
3	SINENKO Lucas, ON/Taifu

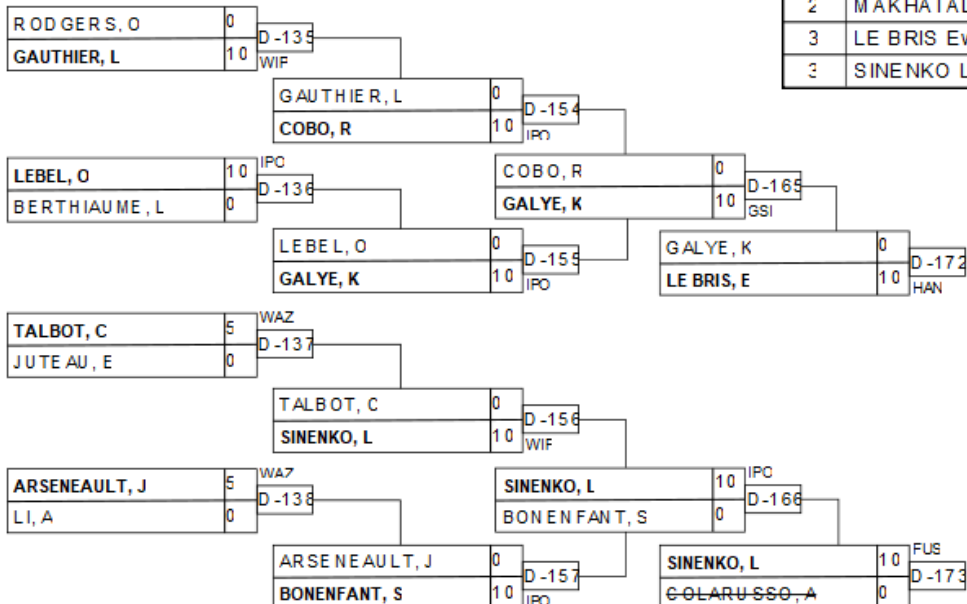

U16M -50kg

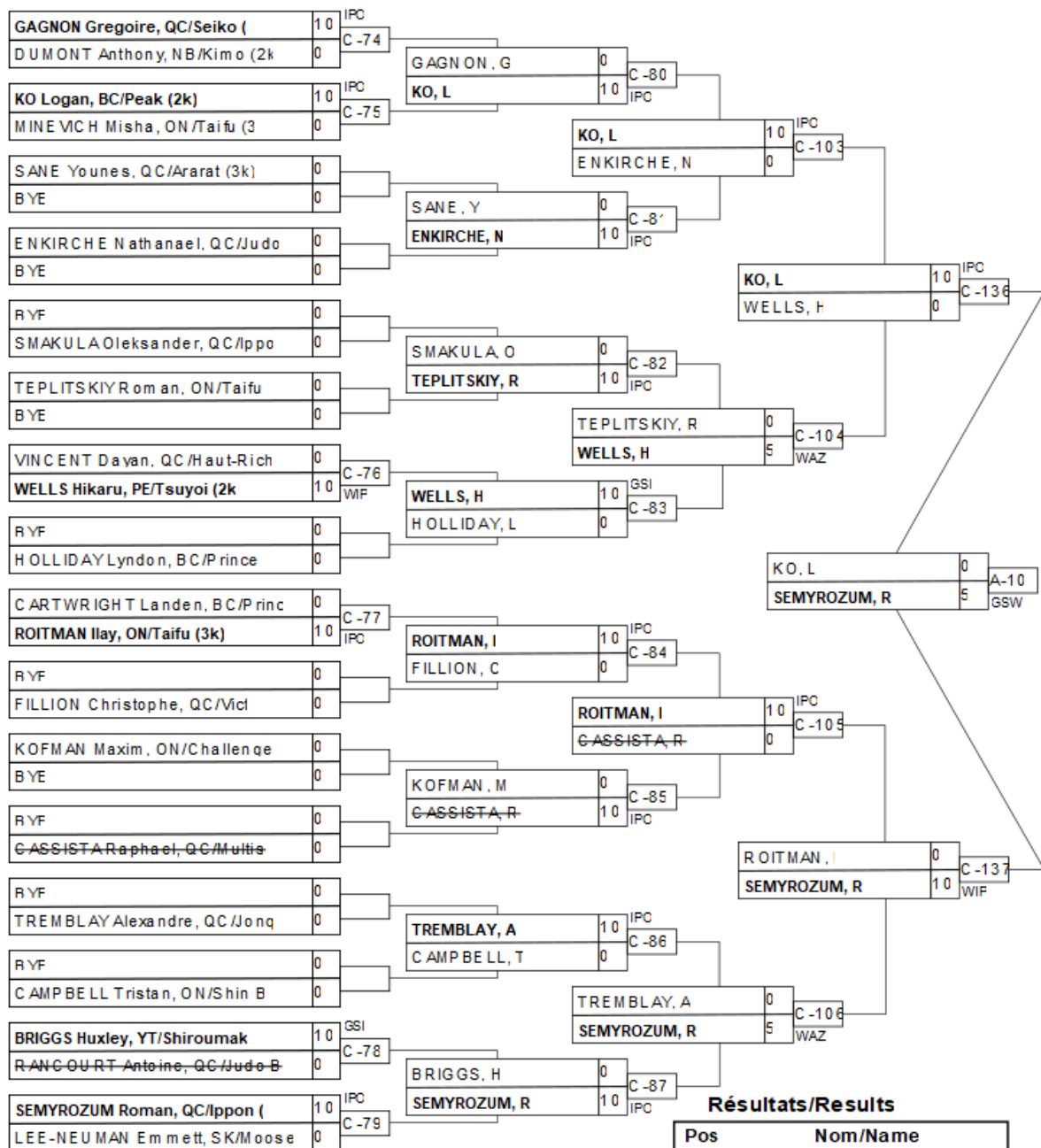

Résultats/Results

Pos	Nom/Name
1	SEMYROZUM Roman, QC/Ippon
2	KO Logan, BC/Peak (2k)
3	WELLS Hikaru, PE/Tsuyoi
3	TEPLITSKIY Roman, ON/Tai

U16M -55kg

PAMPOLINA Bennet, MB/Nakamu	10	IPC			
U DE BASHVILI David, ON/Taifu	0	B-74			
			PAMPOLINA, B	5	WAZ
			JOHNSON, K	0	B-85
JOHNSON Kohen, AB/Tokugawa	10	IPC			
ALIYEV QULIYEV Kemal Pasha,	0	B-75			
			PAMPOLINA, B	0	
			KLYMENKO, M	5	B-100
					WAZ
RYF	0				
BLOUIN Jeremy, QC/CJVR (1k)	0		BLOUIN, J	0	B-86
			KLYMENKO, M	10	IPC
ESTRADA PLANTE Helian, QC/R	0	B-76			
KLYMENKO Maksym, BC/OSP Pol	10	IPC			
			KLYMENKO, M	0	B-142
			KHAHAN ZAMORA,	10	GSI
TAKEKAWA Masato, BC/Nanaimo	0	B-77			
CHOLETTE Isaac, QC/Haut-Ric	10	WIF	CHOLETTE, I	0	B-87
			MICHAUD, M	10	WIF
RYF	0				
MICHAUD Milan, QC/Metropol	0		MICHAUD, M	0	B-101
			KHAHAN ZAMORA,	10	IPC
BULAKH Alexander, ON/Calle	0	B-78			
KHAHAN ZAMORA Ashkan, QC/Tr	10	IPC	KHAHAN ZAMORA,	10	GSW
			BERTEAU, F	0	B-88
BERTEAU Patrick, QC/Olympic	0				
BYE	0				
			KHAHAN ZAMORA,	0	B-111
			TEMIRBAEV, A	10	GSI
ROY MCKEOWN Landenn-Chad, Q	10	WIF			
REXHEPI Santiago Alvaro, ON	0	B-79	ROY MCKEOWN, L	10	FUS
			SALAZAR, M	0	B-89
SALAZAR Matheo, QC/Judo-Bee	0				
BYE	0		ROY MCKEOWN, L	0	B-102
			TEMIRBAEV, A	10	WIF
REDDICK Mekhi, NS/Kanokai (10	IPC			
POLTORATSKIY Matvei, ON/Ta	0	B-80	REDDICK, M	0	B-90
			TEMIRBAEV, A	10	IPC
HAYR APE TYAN Narek, QC/Arara	0	B-81			
TEMIRBAEV Amir, BC/Peak (1k)	10	IPC			
			TEMIRBAEV, A	10	IPC
			SCHIMANN, Y	0	B-143
DELYE Pierre-Emmanuel, QC/S	10	IPC			
LEUNG Katsuya, AB/Hiro's (2	0	B-82	DELYE, F	0	B-91
			SCHIMANN, Y	10	IPC
SCHIMANN Yannick, BC/Hart (10	WIF			
GOBEL Francois Xavier, QC/	0	B-83			
			SCHIMANN, Y	10	IPC
			LEGAULT, L	0	B-103
LEGAULT Luca, QC/Multisport	0				
BYE	0		LEGAULT, L	10	IPC
			KHILOV, M	0	B-92
COTE-MILLIARD Brad, QC/Mult	0	B-84			
KHILOV Maksim, ON/Taifu (3k)	10	IPC			

Résultats/Results

Pos	Nom/Name
1	TEMIRBAEV Amir, BC/Peak
2	KHAHAN ZAMORA Ashkan, QC
3	ALIYEV QULIYEV Kemal Pas
3	PAMPOLINA Bennet, MB/Nak

U16M -60kg

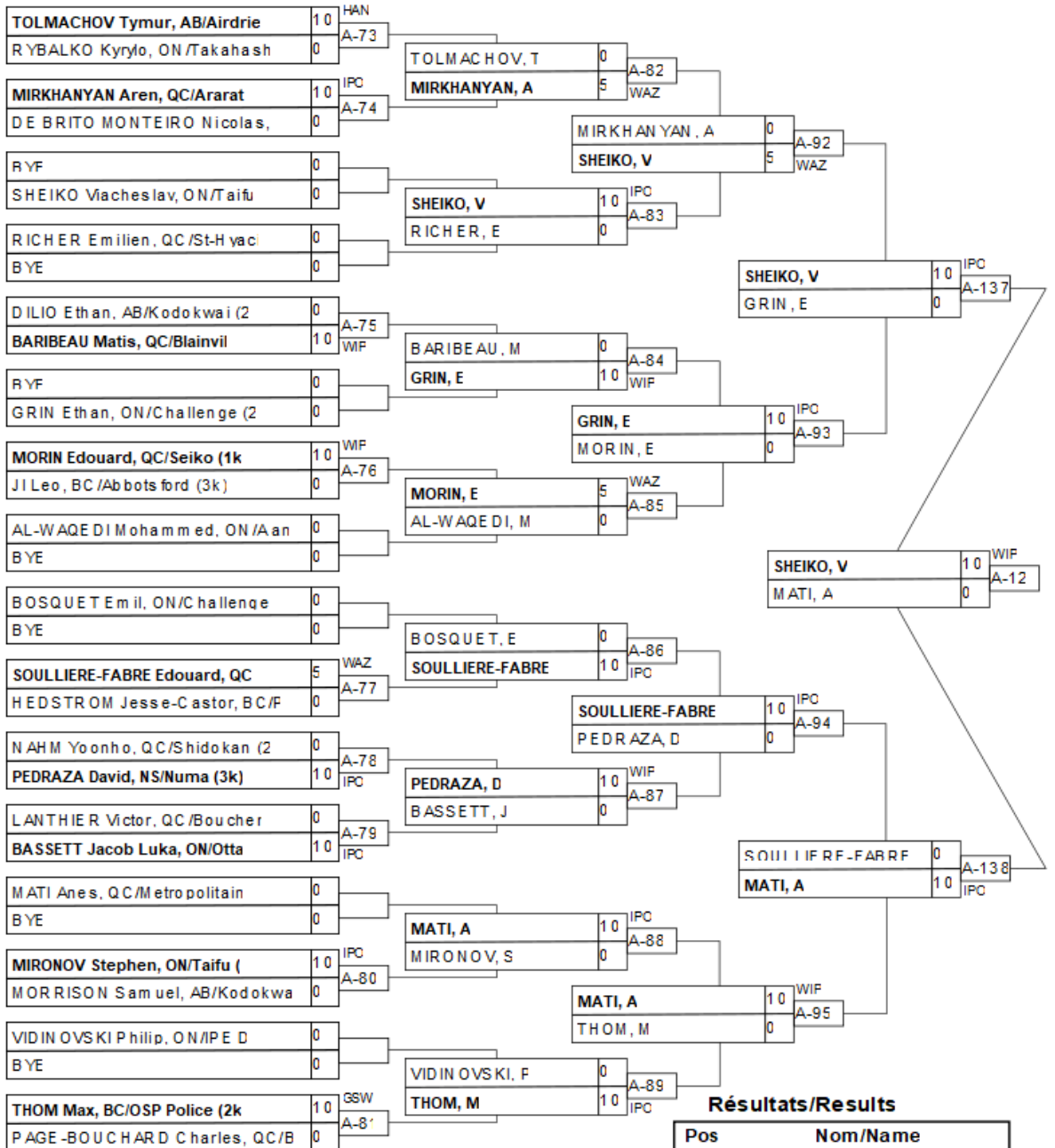

Résultats/Results

Pos	Nom/Name
1	SHEIKO Viacheslav, ON/Ta
2	MATI Anes, QC/Metropolit
3	THOM Max, BC/OSP Police
4	SOULLIERE-FABRE Edouard,

U16M -73kg

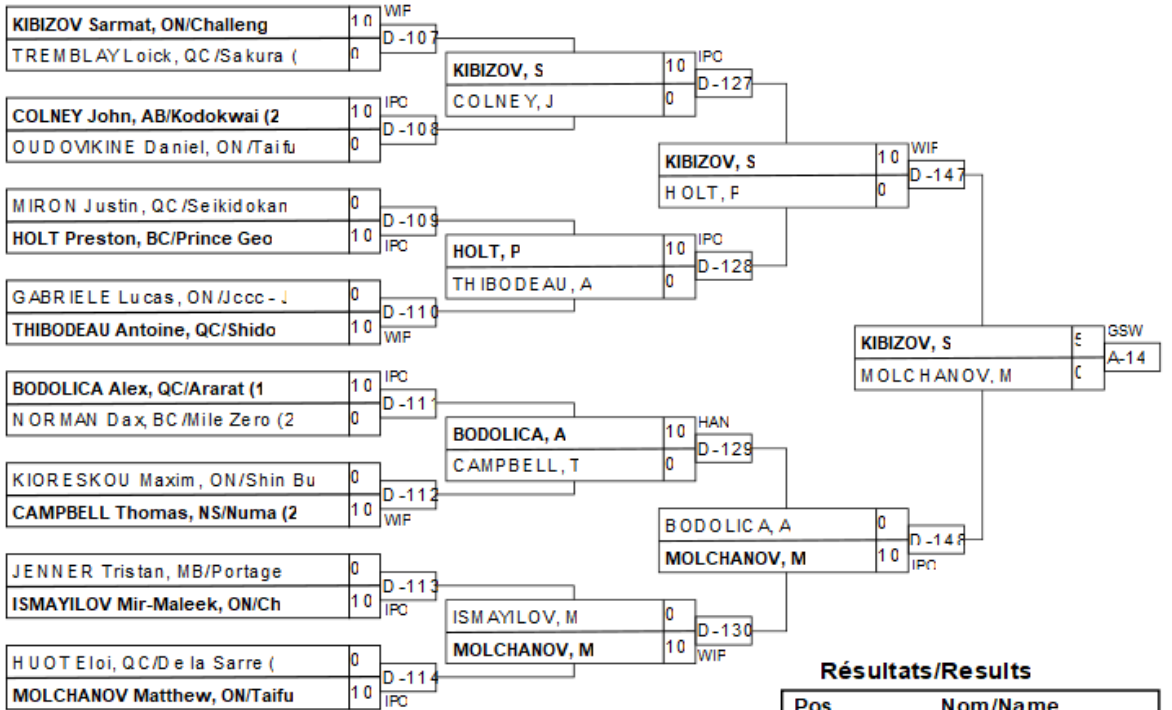

Résultats/Results

Pos	Nom/Name
1	KIBIZOV Sarmat, ON/Chall
2	MOLCHANOV M atthew, ON/Ta
3	CAMPBELL Thomas, NS/Numa
3	NORMAN Dax, BC/Mile Zero

U16M +73kg

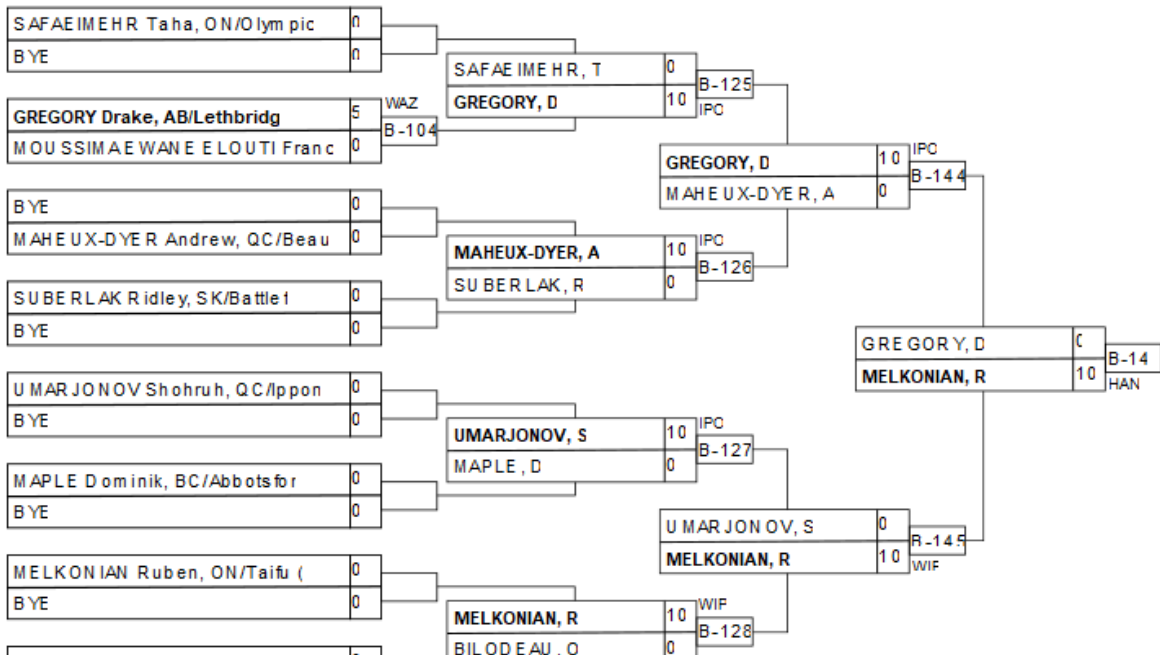

Résultats/Results

Pos	Nom/Name
1	MELKONIAN Ruben, ON/Taifu
2	GREGORY Drake, AB/Lethbr
3	MOUSSIMAE WANE ELOUTI Franc
3	UMARJONOV Shohruh, QC/Ippon

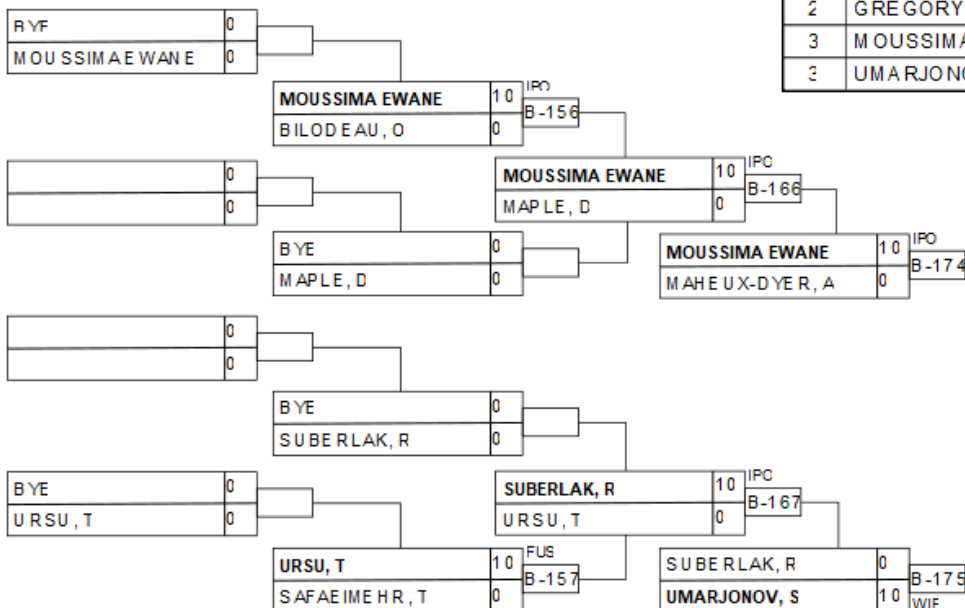

U21F -48kg

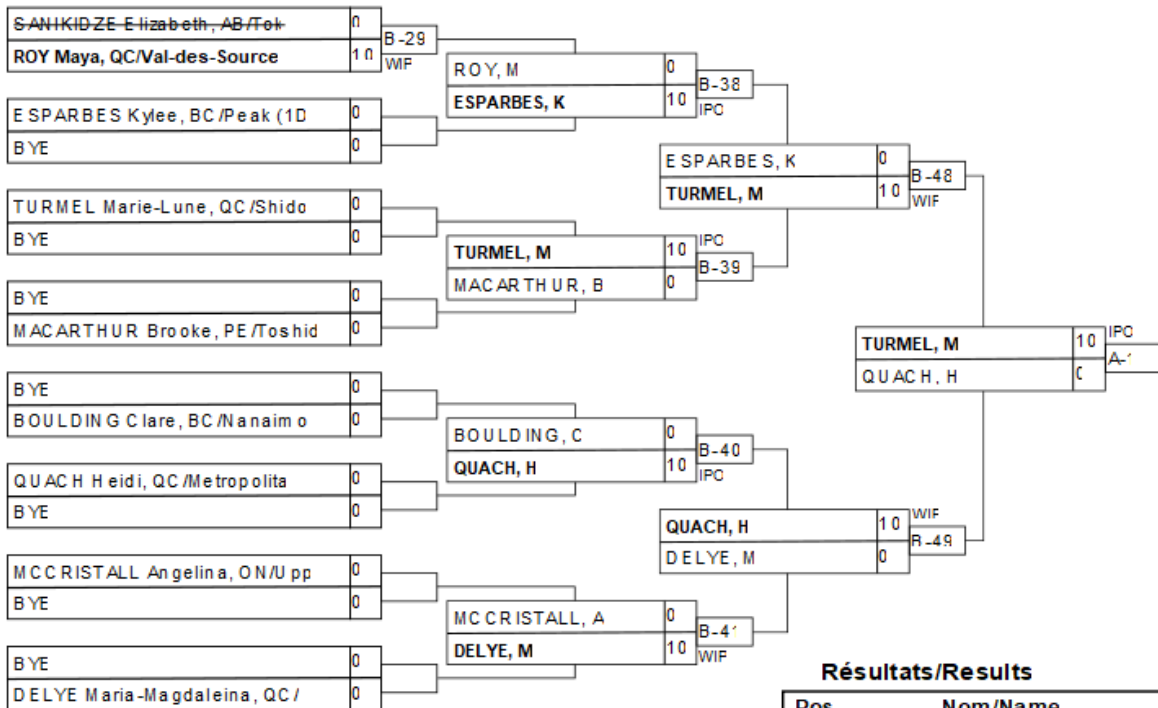

Résultats/Results

Pos	Nom/Name
1	TURMEL Marie-Lune, QC/Shido
2	QUACH Heidi, QC/Metropolita
3	ESPARBES Kylee, BC/Peak (1D)
3	DELYE Maria-Magdaleina, QC/

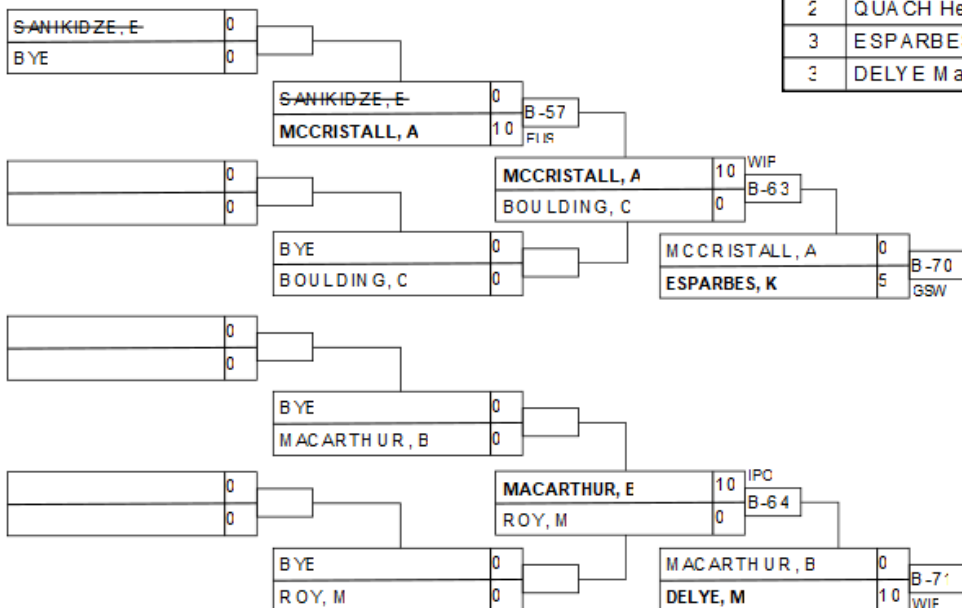

U21F -52kg

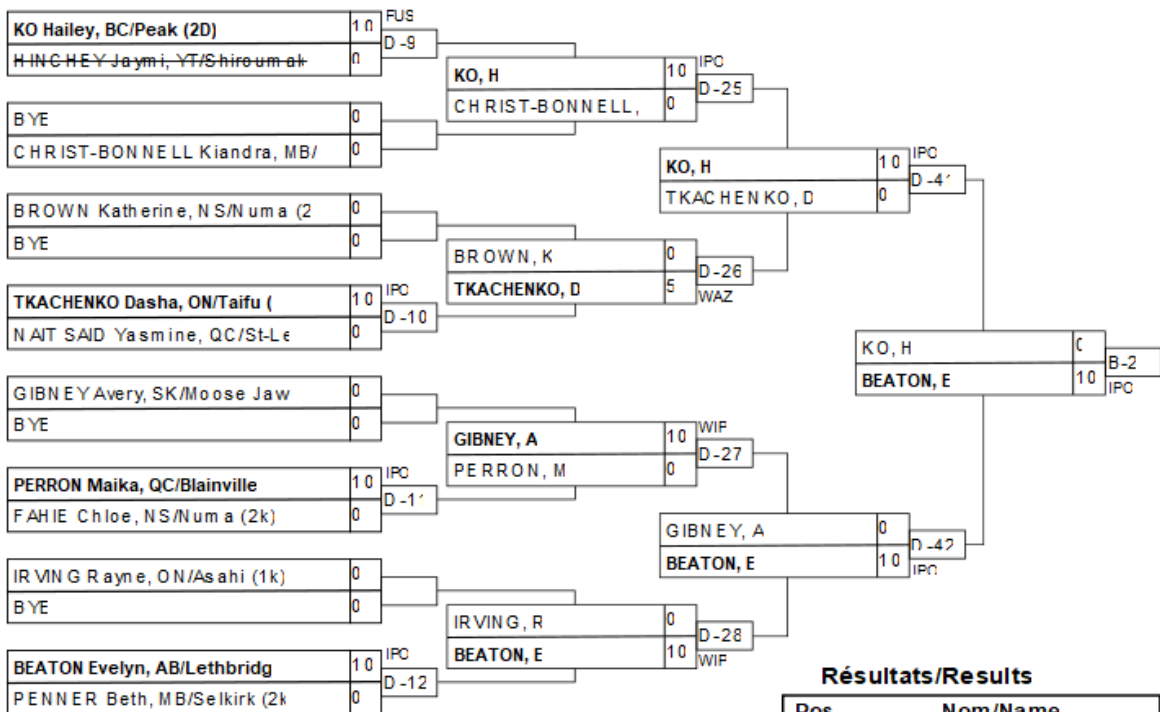

Résultats/Results

Pos	Nom/Name
1	BEATON Evelyn, AB/Lethbr
2	KO Hailey, BC/Peak (2D)
3	TKACHENKO Dasha, ON/Taif
3	BROWN Katherine, NS/Num a

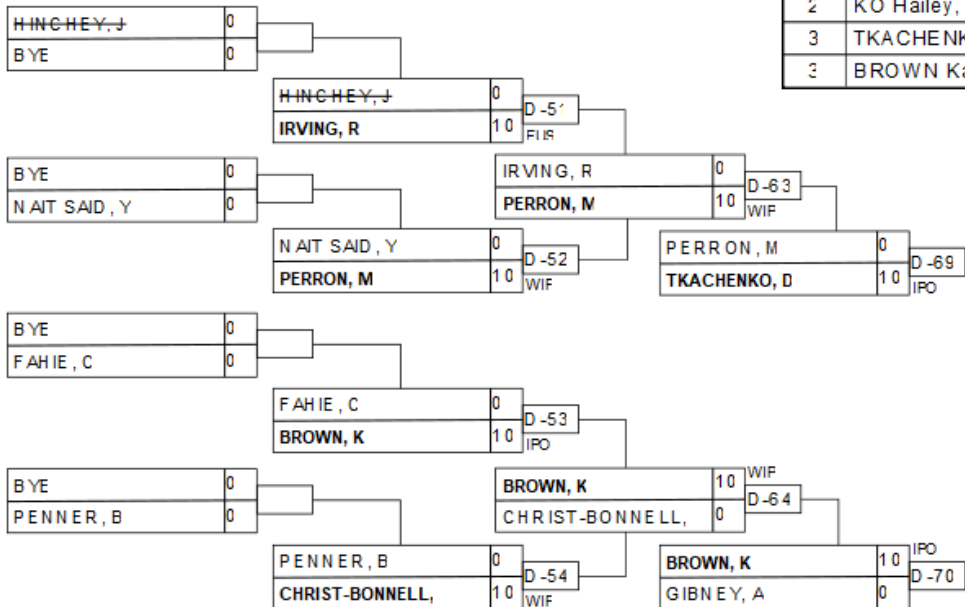

U21F -57kg

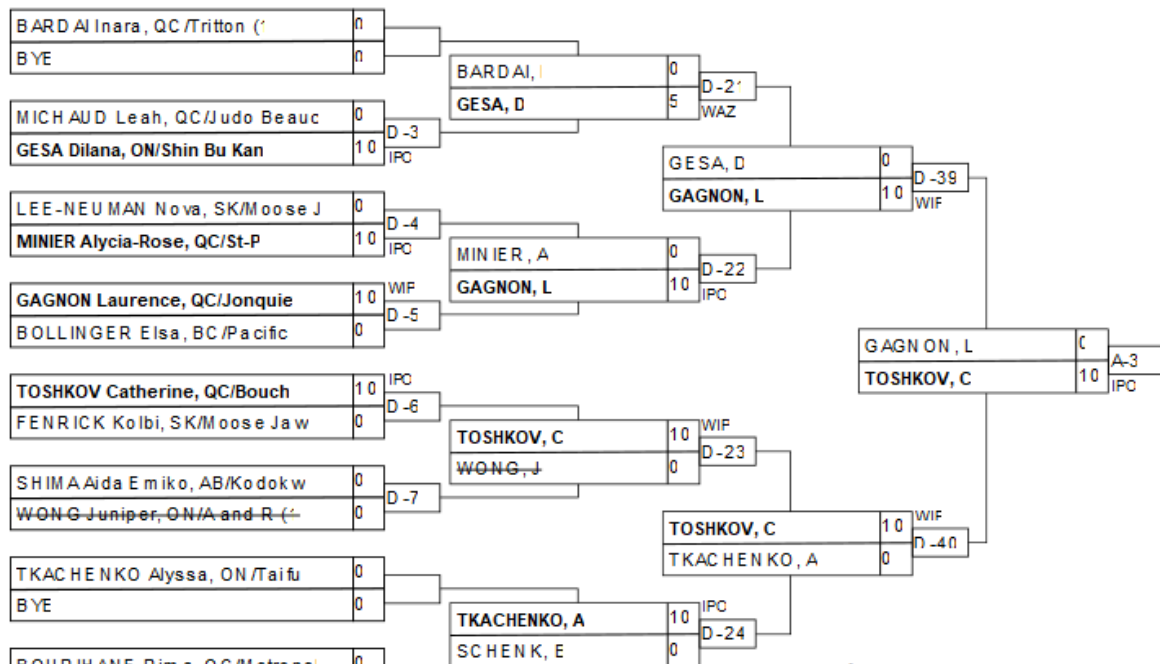

Résultats/Results

Pos	Nom/Name
1	TOSHKOV Catherine, QC/Bouch
2	GAGNON Laurence, QC/Jonquie
3	GESA Dilana, ON/Shin Bu Kan
3	TKACHENKO Alyssa, ON/Tai fu

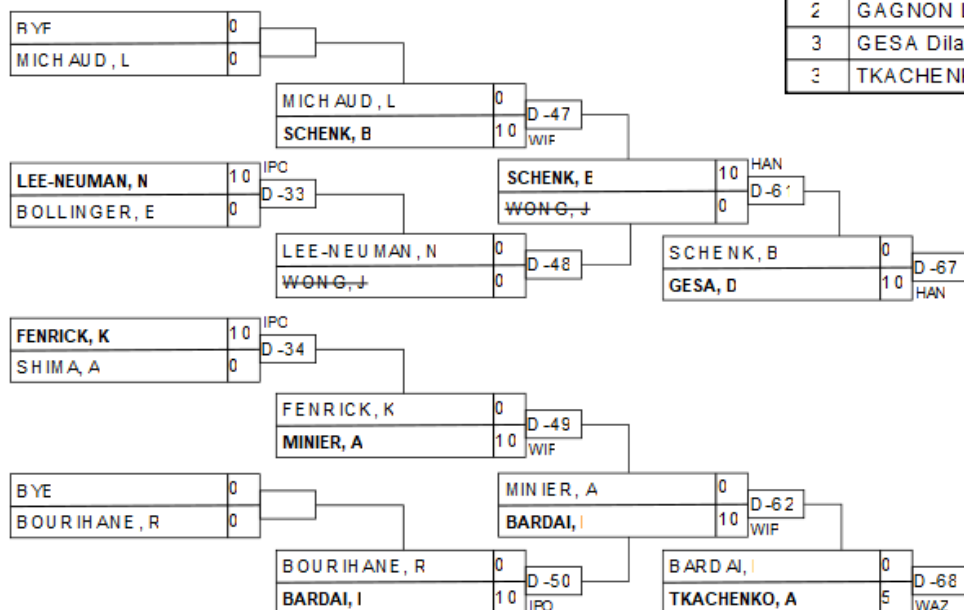

U21F -63kg

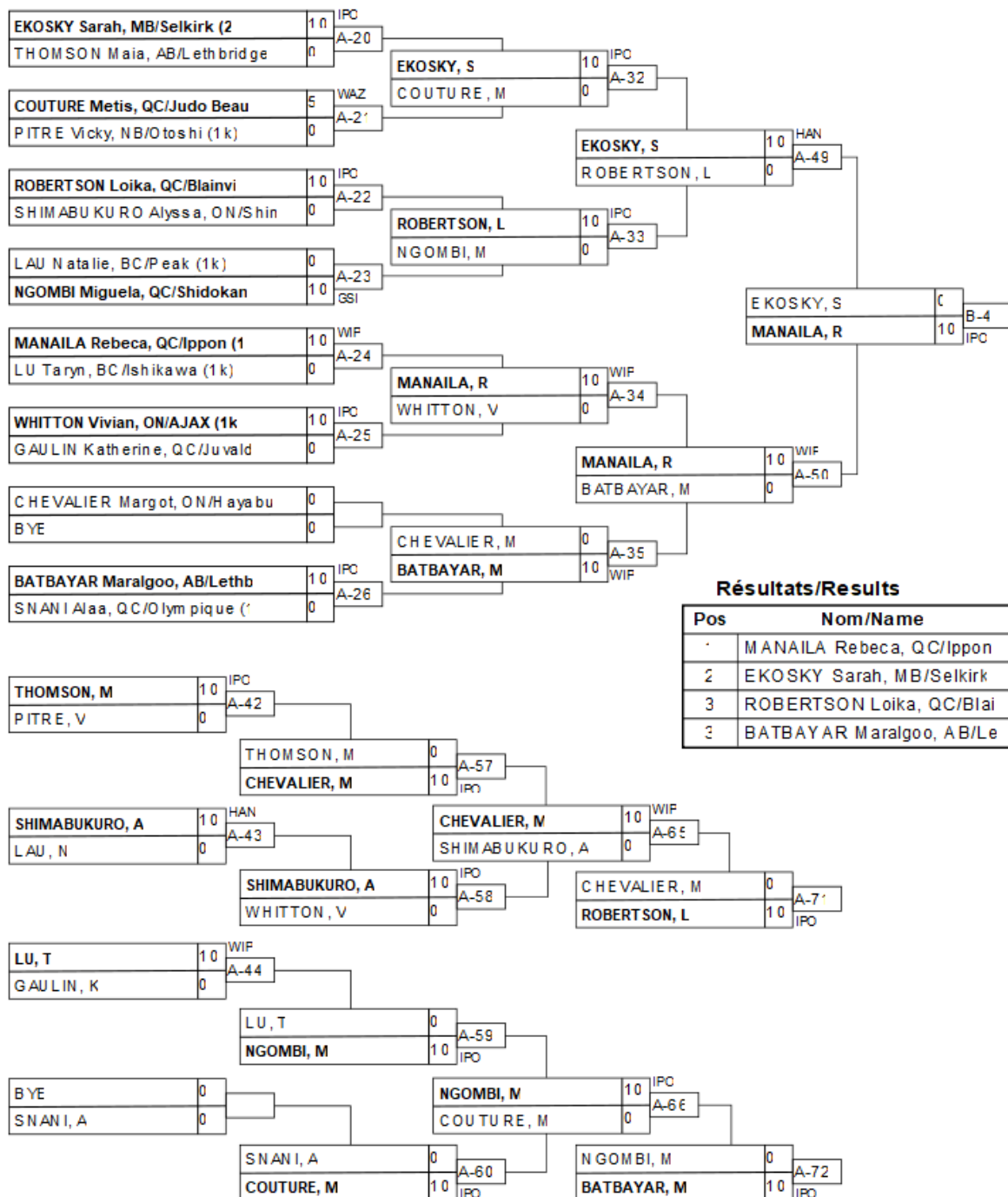

Résultats/Results

Pos	Nom/Name
1	MANAILA Rebeca, QC/Ippon
2	EKOSKY Sarah, MB/Selkirk
3	ROBERTSON Loika, QC/Blai
3	BATBAYAR Maralgoo, A/B/Le

U21F -70kg

Compétiteurs/Competitors A

#	Nom/Name	Grade	Club	1	2	3	4	G/W	Pts	Pos
1	GODIN Aryanna	1k	ON/Uplands	XX				0	0	4
2	DORVAL-MBELE Missy Jen	1k	QC/Metropolitain	10	XX	10	10	3	30	1
3	MACDONALD Savannah	1D	ON/Huntsville	10		XX	10	2	20	2
4	FORTIER Kaylee	2k	YT/Shiroumakai	10			XX	1	10	3

Pool A

Match	Blanc/White			Bleu/Blue	Rés/Res	Tmp/Tim	Code
C-47	GODIN Aryanna	1	2	DORVAL-MBELE Missy Jen	0 - 10	0:37	IPO
C-48	MACDONALD Savannah	3	4	FORTIER Kaylee	10 - 0	0:38	IPO
C-58	GODIN Aryanna	1	3	MACDONALD Savannah	0 - 10	1:50	IPO
C-59	DORVAL-MBELE Missy Jen	2	4	FORTIER Kaylee	10 - 0	0:33	WIP
C-65	GODIN Aryanna	1	4	FORTIER Kaylee	0 - 10	0:38	IPO
C-66	DORVAL-MBELE Missy Jen	2	3	MACDONALD Savannah	10 - 0	0:49	WIP

Compétiteurs/Competitors B

#	Nom/Name	Grade	Club	5	6	7	G/W	Pts	Pos
5	BRAGINSKY Sabrina	1k	ON/Challenge	XX			0	0	3
6	SMITH Abigail	1k	NS/Numa	10	XX		1	10	2
7	COSSITT Elizabeth	1k	AB/Kodokwai	10	5	XX	2	15	1

Pool B

Match	Blanc/White			Bleu/Blue	Rés/Res	Tmp/Tim	Code
C-49	BRAGINSKY Sabrina	5	6	SMITH Abigail	0 - 10	0:56	IPO
C-60	BRAGINSKY Sabrina	5	7	COSSITT Elizabeth	0 - 10	0:00	FUS
C-67	SMITH Abigail	6	7	COSSITT Elizabeth	0 - 5	4:00	WAZ

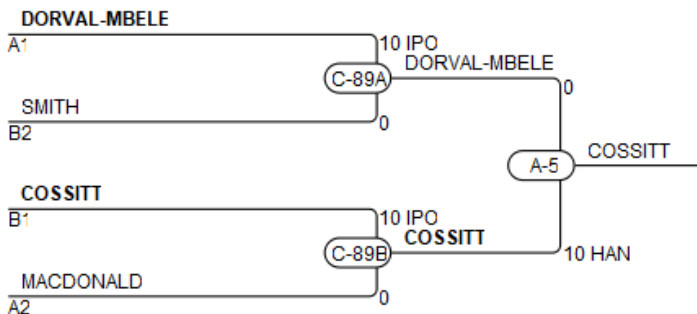

Résultats/Results

Pos	Nom/Name
1	COSSITT Elizabeth, AB/Kodokwai
2	DORVAL-MBELE Missy Jen, QC/Metropolitain
3	SMITH Abigail, NS/Numa
3	MACDONALD Savannah, ON/Huntsville

U21F -70kg (TB-A)

Compétiteurs/Competitors

#	Nom/Name	Grade	Club	1	2	3	G/W	Pts	Pos
1	GODIN Aryanna	1k	ON/Uplands	XX			0	0	3
2	MACDONALD Savannah	1D	ON/Huntsville	10	XX	10	2	20	1
3	FORTIER Kaylee	2k	YT/Shiroumakai	10		XX	1	10	2

Matches/Matches

Match	Blanc/White			Bleu/Blue	Rés/Res	Tmp/Tim	Code
C-75A	GODIN Aryanna	1	2	MACDONALD Savannah	0 - 10	0:47	GSI
C-78A	GODIN Aryanna	1	3	FORTIER Kaylee	0 - 10	0:41	GSI
C-82A	MACDONALD Savannah	2	3	FORTIER Kaylee	10 - 0	0:00	IPO

Résultats/Results

Pos	Nom/Name
1	MACDONALD Savannah, ON/Huntsville
2	FORTIER Kaylee, YT/Shiroumakai

U21F +78kg

Compétiteurs/Competitors A

#	Nom/Name	Grade	Club	1	2	3	G/W	Pts	Pos
1	VERGE Kandice	2k	NS/Spryfield	XX			0	0	3
2	LAVIGNE Frederique	1D	QC/Metropolitain	10	XX	10	2	20	1
3	KOFMAN Alisa	1k	ON/Challenge	10		XX	1	10	2

Pool A

Match	Blanc/White			Bleu/Blue	Rés/Res	Tmp/Tim	Code
A-36	VERGE Kandice	1	2	LAVIGNE Frederique	0 - 10	1:28	HAN
A-45	VERGE Kandice	1	3	KOFMAN Alisa	0 - 10	1:48	IPO
A-51	LAVIGNE Frederique	2	3	KOFMAN Alisa	10 - 0	1:58	WIP

Compétiteurs/Competitors B

#	Nom/Name	Grade	Club	4	5	6	G/W	Pts	Pos
4	HARRIS Emily	1k	ON/Mountainside	XX	10		1	10	2
5	SIMMONDS Kathleen	1k	NT/Fort Providence		XX		0	0	3
6	KARAS Marianna	1D	AB/Kodokwai	10	10	XX	2	20	1

Pool B

Match	Blanc/White			Bleu/Blue	Rés/Res	Tmp/Tim	Code
A-37	HARRIS Emily	4	5	SIMMONDS Kathleen	10 - 0	1:15	IPO
A-46	HARRIS Emily	4	6	KARAS Marianna	0 - 10	0:48	WIP
A-52	SIMMONDS Kathleen	5	6	KARAS Marianna	0 - 10	0:26	IPO

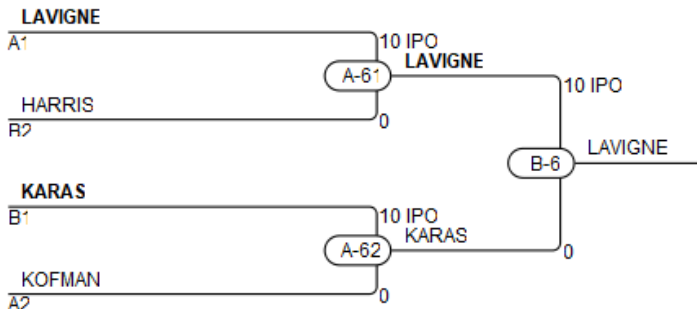

Résultats/Results

Pos	Nom/Name
1	LAVIGNE Frederique, QC/Metropolitain
2	KARAS Marianna, AB/Kodokwai
3	HARRIS Emily, ON/Mountainside
3	KOFMAN Alisa, ON/Challenge

U21M -100kg

Compétiteurs/Competitors A

#	Nom/Name	Grade	Club	1	2	3	4	G/W	Pts	Pos
1	LUCHKIN Nick	1k	ON/Challenge	XX	10	10	10	3	30	1
2	JAMES Cai	2k	MB/Balmoral		XX			0	0	4
3	CIUPE Alex Jr	1k	QC/Shidokan		10	XX	10	2	20	2
4	KHALFON Eden	1k	ON/Taifu		5		XX	1	5	3

Pool A

Match	Blanc/White			Bleu/Blue	Rés/Res	Tmp/Tim	Code
B-50	LUCHKIN Nick	1	2	JAMES Cai	10 - 0	1:05	WIP
B-51	CIUPE Alex Jr	3	4	KHALFON Eden	10 - 0	0:25	IPO
B-58	LUCHKIN Nick	1	3	CIUPE Alex Jr	10 - 0	3:17	IPO
B-59	JAMES Cai	2	4	KHALFON Eden	0 - 5	4:00	WAZ
B-65	LUCHKIN Nick	1	4	KHALFON Eden	10 - 0	1:08	WIP
B-66	JAMES Cai	2	3	CIUPE Alex Jr	0 - 10	0:09	IPO

Compétiteurs/Competitors B

#	Nom/Name	Grade	Club	5	6	7	G/W	Pts	Pos
5	SILEM Mohamed Amine	1D	QC/Metropolitain	XX	5	10	2	15	1
6	VELASQUEZ KASAP Abel	1k	BC/OSP Police		XX	10	1	10	2
7	GAUDET Ethan	1k	PE/Toshidokan			XX	0	0	3

Pool B

Match	Blanc/White			Bleu/Blue	Rés/Res	Tmp/Tim	Code
B-52	SILEM Mohamed Amine	5	6	VELASQUEZ KASAP Abel	5 - 0	4:00	WAZ
B-60	SILEM Mohamed Amine	5	7	GAUDET Ethan	10 - 0	1:53	IPO
B-67	VELASQUEZ KASAP Abel	6	7	GAUDET Ethan	10 - 0	1:12	IPO

LUCHKIN

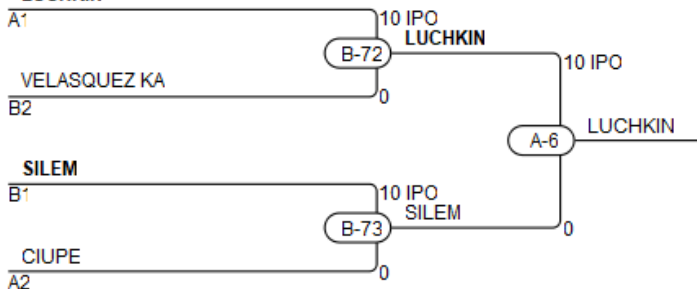

Résultats/Results

Pos	Nom/Name
1	LUCHKIN Nick, ON/Challenge
2	SILEM Mohamed Amine, QC/Metropolitain
3	VELASQUEZ KASAP Abel, BC/OSP Police
3	CIUPE Alex Jr, QC/Shidokan

U21M -60kg

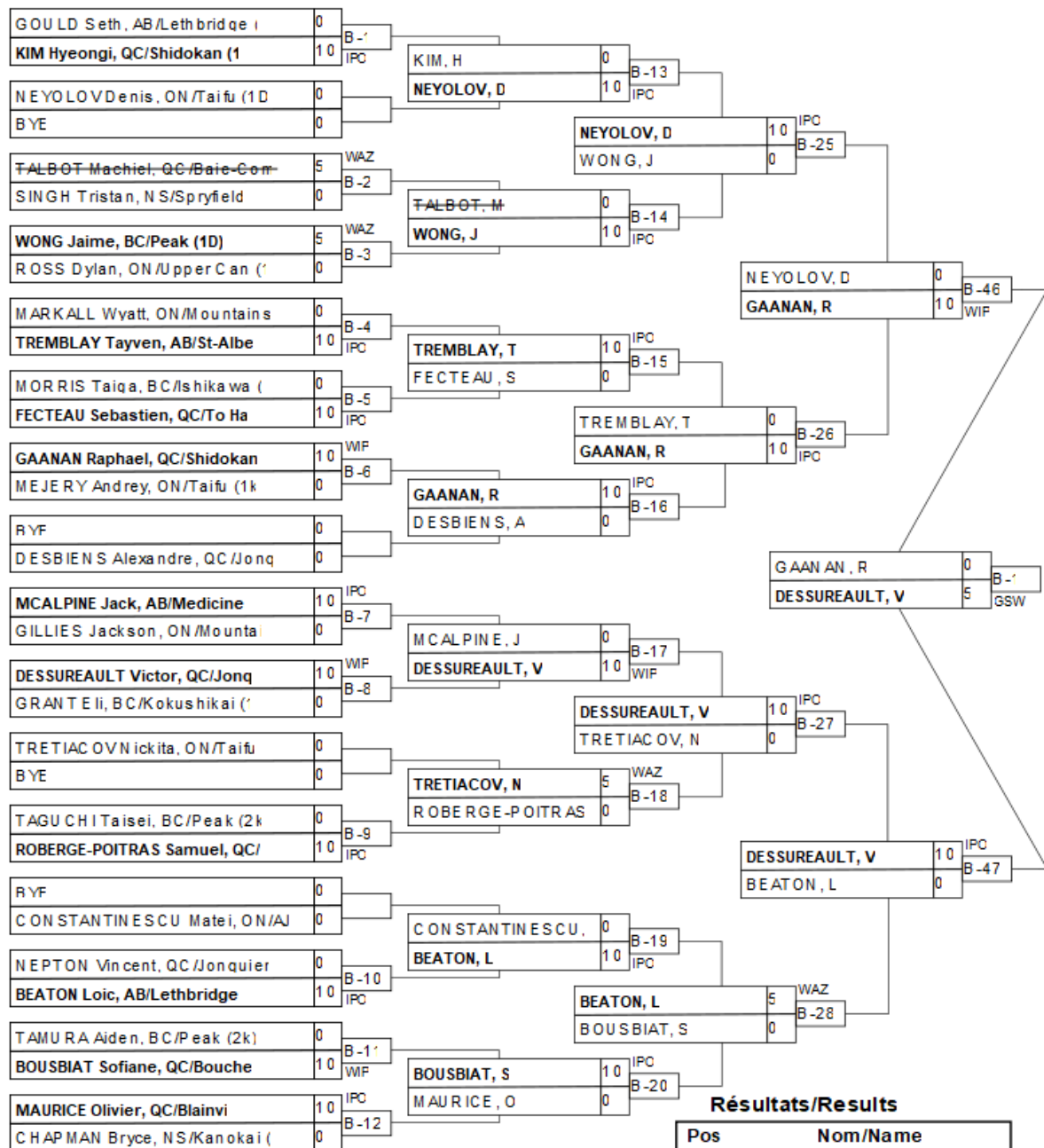

Résultats/Results

Pos	Nom/Name
1	DESSUREAULT Victor, QC/J
2	GAANAN Raphael, QC/Shido
3	NEYOLOV Denis, ON/Taifu
4	BEATON Loic, AB/Lethbrid

U21M -66kg

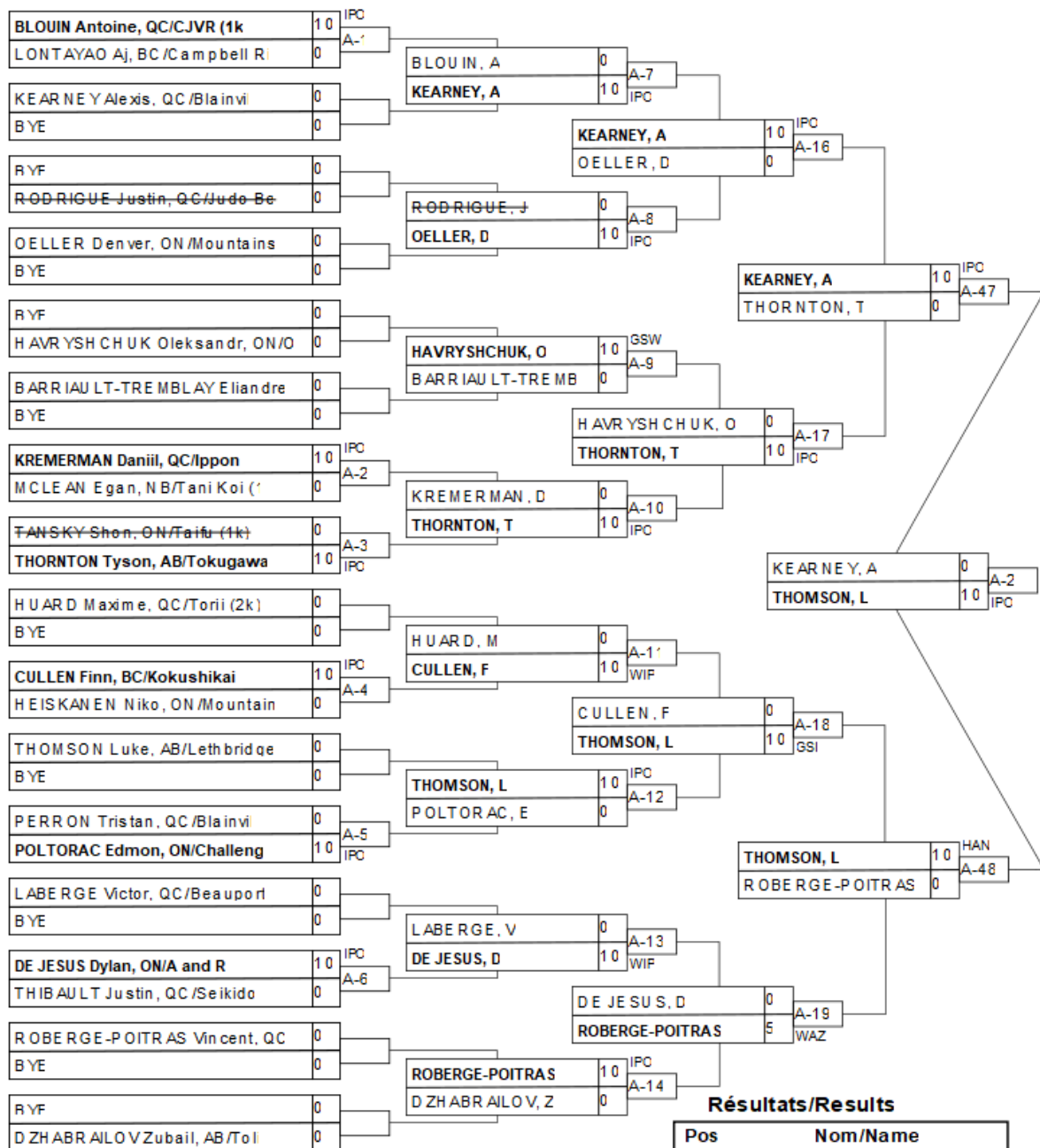

Résultats/Results

Pos	Nom/Name
1	THOMSON Luke, AB/Lethbridge
2	KEARNEY Alexis, QC/Blainville
3	KREMERMANN Daniil, QC/Ippon
4	THIBAULT Justin, QC/Seikido

U21M -73kg

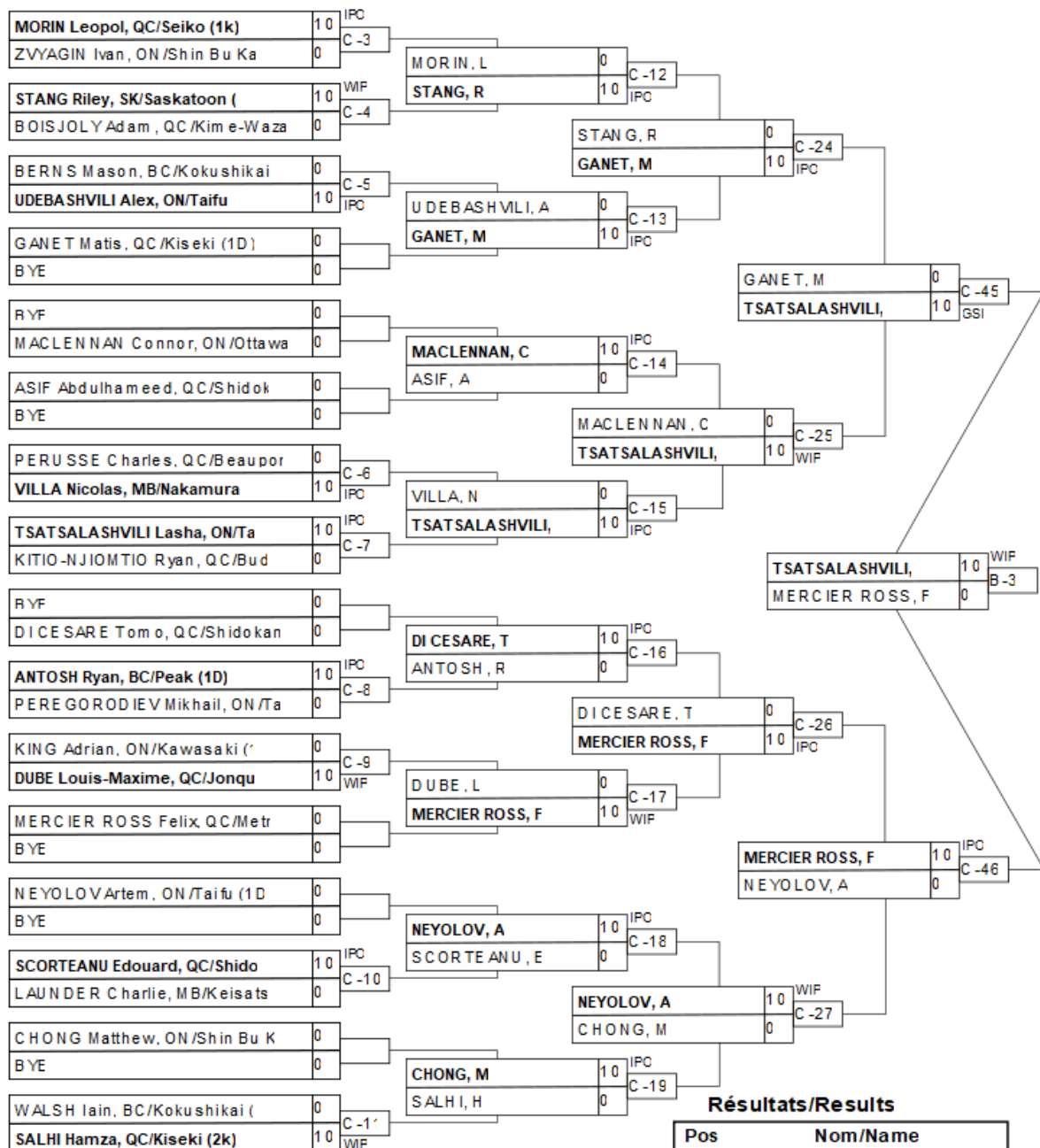

Résultats/Results

Pos	Nom/Name
1	TSATSALASHVILI Lasha, ON
2	MERCIER ROSS Felix, QC/M
3	GANET Matis, QC/Kiseki (
3	NEYOLOV Artem, ON/Taifu

U21M -81kg

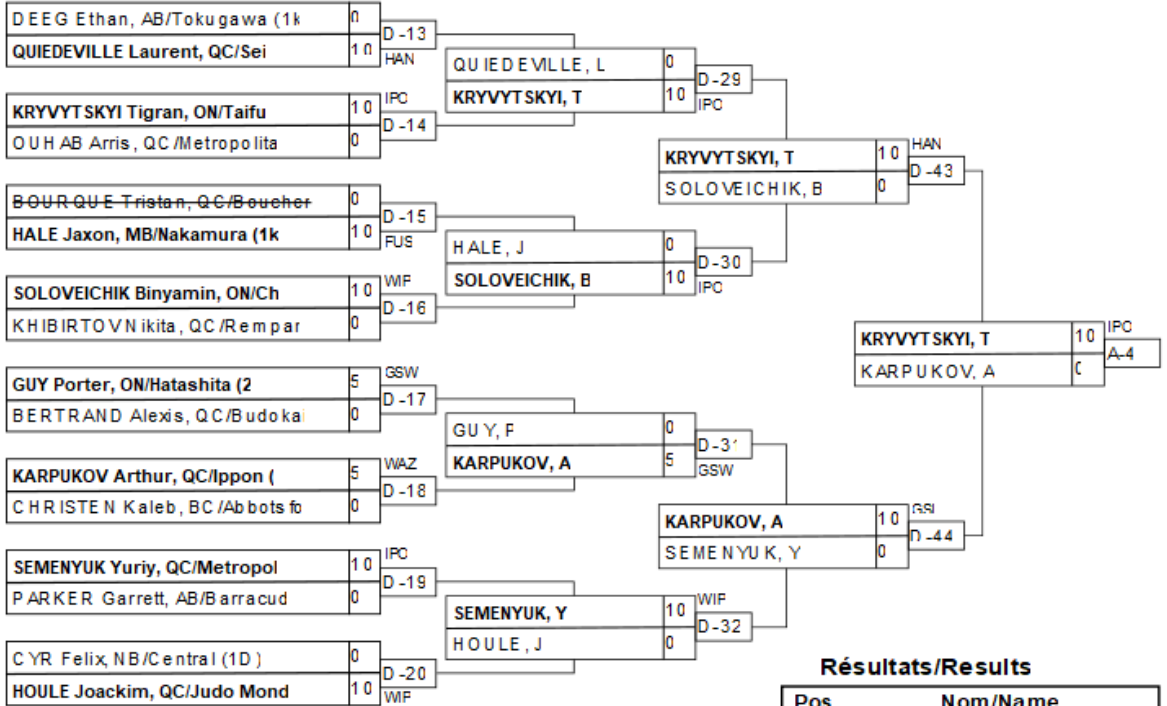

Résultats/Results

Pos	Nom/Name
1	KRYVYTSKYI Tigran, ON/Ta
2	KARPUKOV Arthur, QC/Ippo
3	SOLOVEICHIK Binyamin, ON
3	QUIEDEVILLE Laurent, QC/

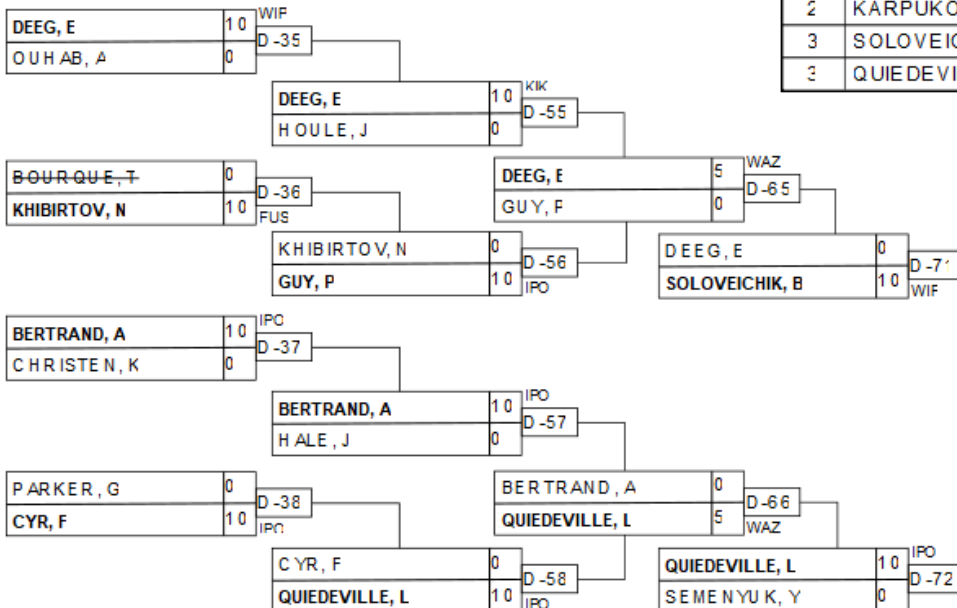

U21M -90kg

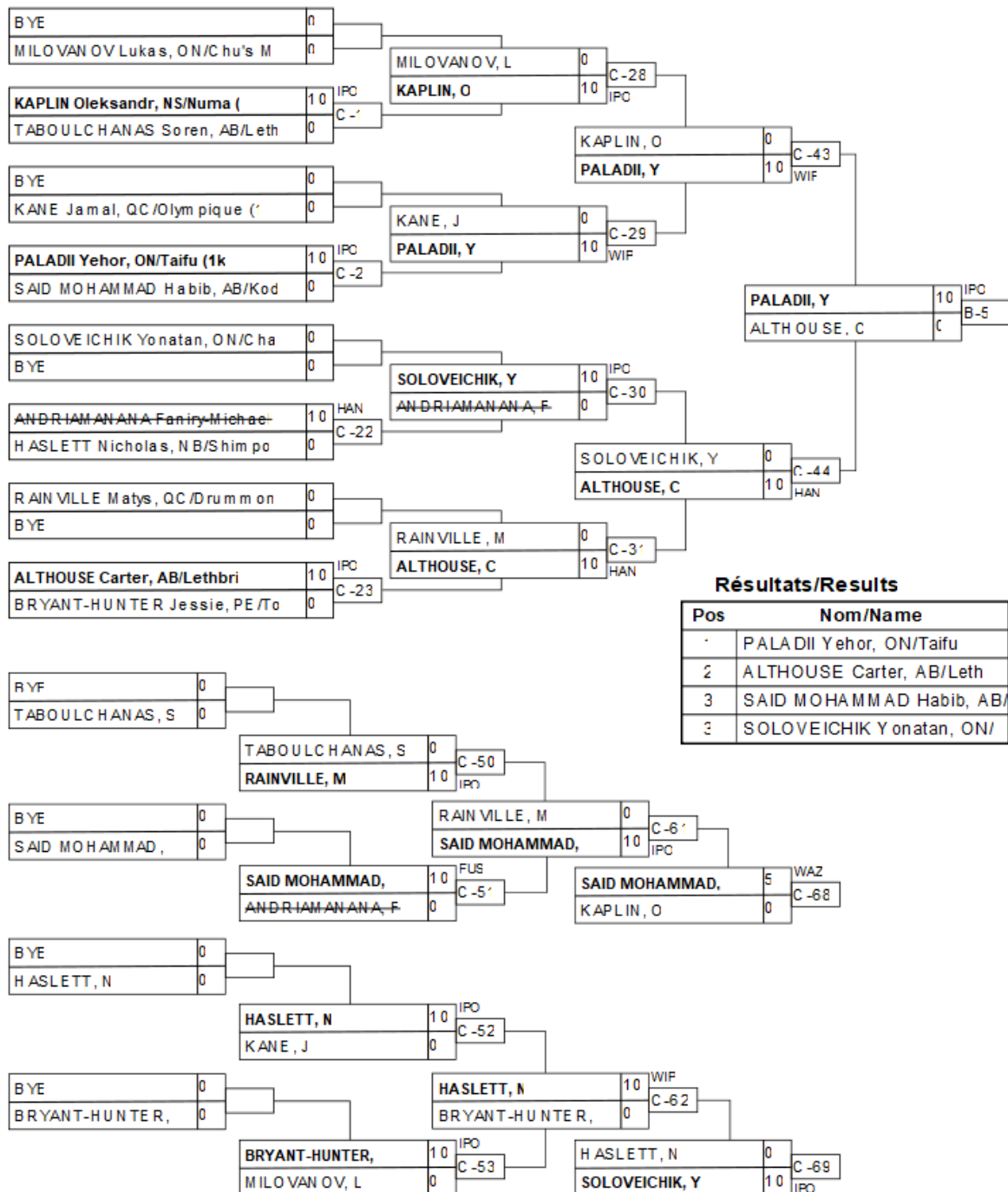

U21M +100kg

Compétiteurs/Competitors

#	Nom/Name	Grade	Club	1	2	3	4	G/W	Pts	Pos
1	POWER William	1D	QC/Fermont	XX				0	0	4
2	BELAL Rayan	1k	QC/Olympique	10	XX	10		2	20	1
3	ALLEN Lucas	1k	ON/Huntsville	10		XX	10	2	20	2
4	STIVENSON Arthur	2k	AB/Lethbridge	5	5		XX	2	10	3

Matches/Matches

Match	Blanc/White			Bleu/Blue	Rés/Res	Tmp/Tim	Code
D-1	POWER William	1	2	BELAL Rayan	0 - 10	0:54	WIP
D-2	ALLEN Lucas	3	4	STIVENSON Arthur	10 - 0	4:00	WIP
D-45	POWER William	1	3	ALLEN Lucas	0 - 10	1:54	WIP
D-46	BELAL Rayan	2	4	STIVENSON Arthur	0 - 5	4:00	WAZ
D-59	POWER William	1	4	STIVENSON Arthur	0 - 5	4:00	WAZ
D-60	BELAL Rayan	2	3	ALLEN Lucas	10 - 0	0:24	IPO

Résultats/Results

Pos	Nom/Name
1	BELAL Rayan, QC/Olympique
2	ALLEN Lucas, ON/Huntsville
3	STIVENSON Arthur, AB/Lethbridge