



# Int Male -60kg



## Competitors/Compétiteurs

#	Name/Nom	Grade	Club	1	2	1	2	1	2	W/G	Pts	Pos
1	ORTIZ Jonathan	green	USAJUDO/UW Judo	XX		XX		XX		0	0	2
2	WYMAN Brody	green	BC/Westsyde	10	XX	10	XX		XX	2	20	1

## Matches/Matches

Match	White/Blanc			Blue/Bleu	Res/Rés	Tim/Tmp	Code
C-23	ORTIZ Jonathan	1	2	WYMAN Brody	0 - 10	0:27	IPO
C-34	WYMAN Brody	2	1	ORTIZ Jonathan	10 - 0	1:41	IPO
C-45	ORTIZ Jonathan	1	2	WYMAN Brody			

## Results/Résultats

Pos	Name/Nom
1	WYMAN Brody, BC/Westsyde



# Int Male -66kg



## Competitors/Compétiteurs

#	Name/Nom	Grade	Club	1	2	3	4	5	W/G	Pts	Pos
1	MOISE David	green	BC/UBC	XX			10		1	10	4
2	BAL Bikrampal	green	BC/White Rock	10	XX	10	10		3	30	2
3	KOKURYO Henry	green/blue	BC/Mudo Martial Arts	10		XX	10		2	20	3
4	LONTAYAO Aj	blue	BC/Campbell River				XX		0	0	5
5	CULLEN Finn	blue	BC/Kokushikai	10	10	10	10	XX	4	40	1

## Matches/Matches

Match	White/Blanc		Blue/Bleu	Res/Rés	Tim/Tmp	Code	
B-10	LONTAYAO Aj	4	5	CULLEN Finn	0 - 10	0:00	KIK
B-11	MOISE David	1	2	BAL Bikrampal	0 - 10	0:07	IPO
B-16	KOKURYO Henry	3	4	LONTAYAO Aj	10 - 0	0:00	KIK
B-17	MOISE David	1	5	CULLEN Finn	0 - 10	0:14	IPO
B-22	BAL Bikrampal	2	3	KOKURYO Henry	10 - 0	1:19	IPO
B-23	MOISE David	1	4	LONTAYAO Aj	10 - 0	0:00	KIK
B-31	KOKURYO Henry	3	5	CULLEN Finn	0 - 10	1:47	IPO
B-32	BAL Bikrampal	2	4	LONTAYAO Aj	10 - 0	0:00	KIK
B-39	MOISE David	1	3	KOKURYO Henry	0 - 10	0:50	IPO
B-40	BAL Bikrampal	2	5	CULLEN Finn	0 - 10	1:20	IPO

## Results/Résultats

Pos	Name/Nom
1	CULLEN Finn, BC/Kokushikai
2	BAL Bikrampal, BC/White Rock
3	KOKURYO Henry, BC/Mudo Martial Arts
4	MOISE David, BC/UBC



# Int Male -73kg



## Competitors/Compétiteurs

#	Name/Nom	Grade	Club	1	2	1	2	1	2	W/G	Pts	Pos
1	SHORTER Chad	blue	BC/Smithers	XX		XX		XX		0	0	2
2	BREGET Winter	blue	BC/Lake Country	10	XX	10	XX		XX	2	20	1

## Matches/Matches

Match	White/Blanc			Blue/Bleu	Res/Rés	Tim/Tmp	Code
C-52A	SHORTER Chad	1	2	BREGET Winter	0 - 10	1:14	IPO
C-44	BREGET Winter	2	1	SHORTER Chad	10 - 0	0:38	IPO
C-55	SHORTER Chad	1	2	BREGET Winter			

## Results/Résultats

Pos	Name/Nom
1	BREGET Winter, BC/Lake Country

## Competitors/Compétiteurs A

#	Name/Nom	Grade	Club	1	2	3	4	W/G	Pts	Pos
1	PARK John	blue	BC/Westminster	XX	10	10	10	3	30	1
2	HUBELIT Austin	blue	BC/Campbell River		XX			0	0	4
3	PREVOST Hayden	blue	BC/Hart		10	XX	10	2	20	2
4	LANE Andrew	green	USAJUDO/Northsound Judo	10		XX		1	10	3

## Pool A

Match	White/Blanc	Blue/Bleu	Res/Rés	Tim/Tmp	Code
C-20	PARK John 1 2	HUBELIT Austin	10 - 0	0:45	IPO
C-21	PREVOST Hayden 3 4	LANE Andrew	10 - 0	1:39	IPO
C-31	PARK John 1 3	PREVOST Hayden	10 - 0	0:17	WIP
C-32	HUBELIT Austin 2 4	LANE Andrew	0 - 10	2:42	IPO
C-41	PARK John 1 4	LANE Andrew	10 - 0	0:14	IPO
C-42	HUBELIT Austin 2 3	PREVOST Hayden	0 - 10	0:38	IPO

## Competitors/Compétiteurs B

#	Name/Nom	Grade	Club	5	6	7	W/G	Pts	Pos
5	NEWCOMEN Finn	blue	BC/Kamloops	XX			0	0	3
6	VIRGINILLO Mark	blue	BC/Westminster	10	XX	10	2	20	1
7	HESAMI Jafar	blue	BC/Langley Judo Club	10		XX	1	10	2

## Pool B

Match	White/Blanc	Blue/Bleu	Res/Rés	Tim/Tmp	Code
C-22	NEWCOMEN Finn 5 6	VIRGINILLO Mark	0 - 10	0:00	FUS
C-33	NEWCOMEN Finn 5 7	HESAMI Jafar	0 - 10	0:00	FUS
C-43	VIRGINILLO Mark 6 7	HESAMI Jafar	10 - 0	0:56	WIP

### PARK

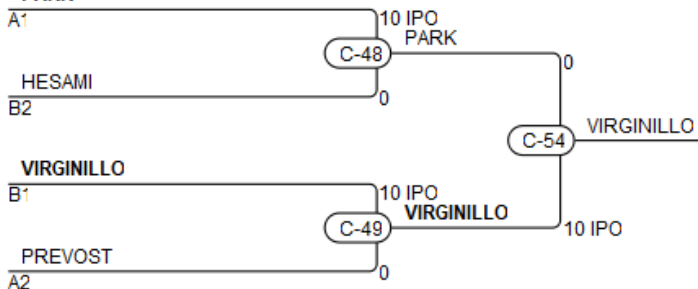

## Results/Résultats

Pos	Name/Nom
1	VIRGINILLO Mark, BC/Westminster
2	PARK John, BC/Westminster
3	HESAMI Jafar, BC/Langley Judo Club
3	PREVOST Hayden, BC/Hart



# Int Male -90kg



## Competitors/Compétiteurs

#	Name/Nom	Grade	Club	1	2	3	4	W/G	Pts	Pos
1	FORSBERG Mattias	blue	AB/Lethbridge	XX				0	0	4
2	HOOVER Stuart	green	AB/Kodokwai	10	XX		10	2	20	2
3	BURGESS Joel	green	BC/White Rock	10	10	XX	10	3	30	1
4	SEYDUZOV Timur	green	USAJUDO/Highlands Judo Dojo	10			XX	1	10	3

## Matches/Matches

Match	White/Blanc			Blue/Bleu	Res/Rés	Tim/Tmp	Code
A-22	FORSBERG Mattias	1	2	HOOVER Stuart	0 - 10	0:56	IPO
A-23	BURGESS Joel	3	4	SEYDUZOV Timur	10 - 0	0:40	IPO
A-34	FORSBERG Mattias	1	3	BURGESS Joel	0 - 10	0:25	IPO
A-35	HOOVER Stuart	2	4	SEYDUZOV Timur	10 - 0	0:35	WIP
A-44	FORSBERG Mattias	1	4	SEYDUZOV Timur	0 - 10	1:36	WIP
A-45	HOOVER Stuart	2	3	BURGESS Joel	0 - 10	0:34	IPO

## Results/Résultats

Pos	Name/Nom
1	BURGESS Joel, BC/White Rock
2	HOOVER Stuart, AB/Kodokwai
3	SEYDUZOV Timur, USAJUDO/Highlands Judo Dojo



# Int Male -100kg



## Competitors/Compétiteurs

#	Name/Nom	Grade	Club	1	2	1	2	1	2	W/G	Pts	Pos
1	HALLETT Josiah	blue	SK/Regina Y	XX	10	XX	10	XX		2	20	1
2	TAMAYOSE Ryu	blue/brown	BC/Steveston		XX		XX		XX	0	0	2

## Matches/Matches

Match	White/Blanc			Blue/Bleu	Res/Rés	Tim/Tmp	Code
1	HALLETT Josiah	1	2	TAMAYOSE Ryu	10 - 0	0:42	IPO
2	TAMAYOSE Ryu	2	1	HALLETT Josiah	0 - 10	1:53	IPO
D-55	HALLETT Josiah	1	2	TAMAYOSE Ryu			

## Results/Résultats

Pos	Name/Nom
1	HALLETT Josiah, SK/Regina Y

## Competitors/Compétiteurs

#	Name/Nom	Grade	Club	1	2	1	2	1	2	W/G	Pts	Pos
1	HELISAZ Hamed	green	BC/UBC	XX		XX	5	XX	10	2	15	1
2	VELASQUEZ KASAP Abel	green	BC/Police Jr.	10	XX		XX		XX	1	10	2

## Matches/Matches

Match	White/Blanc			Blue/Bleu	Res/Rés	Tim/Tmp	Code
A-24	HELISAZ Hamed	1	2	VELASQUEZ KASAP Abel	0 - 10	0:00	FUS
A-36	VELASQUEZ KASAP Abel	2	1	HELISAZ Hamed	0 - 5	3:35	GSW
A-46	HELISAZ Hamed	1	2	VELASQUEZ KASAP Abel	10 - 0	2:53	IPO

## Results/Résultats

Pos	Name/Nom
1	HELISAZ Hamed, BC/UBC
2	VELASQUEZ KASAP Abel, BC/Police Jr.



# Senior Female -48kg

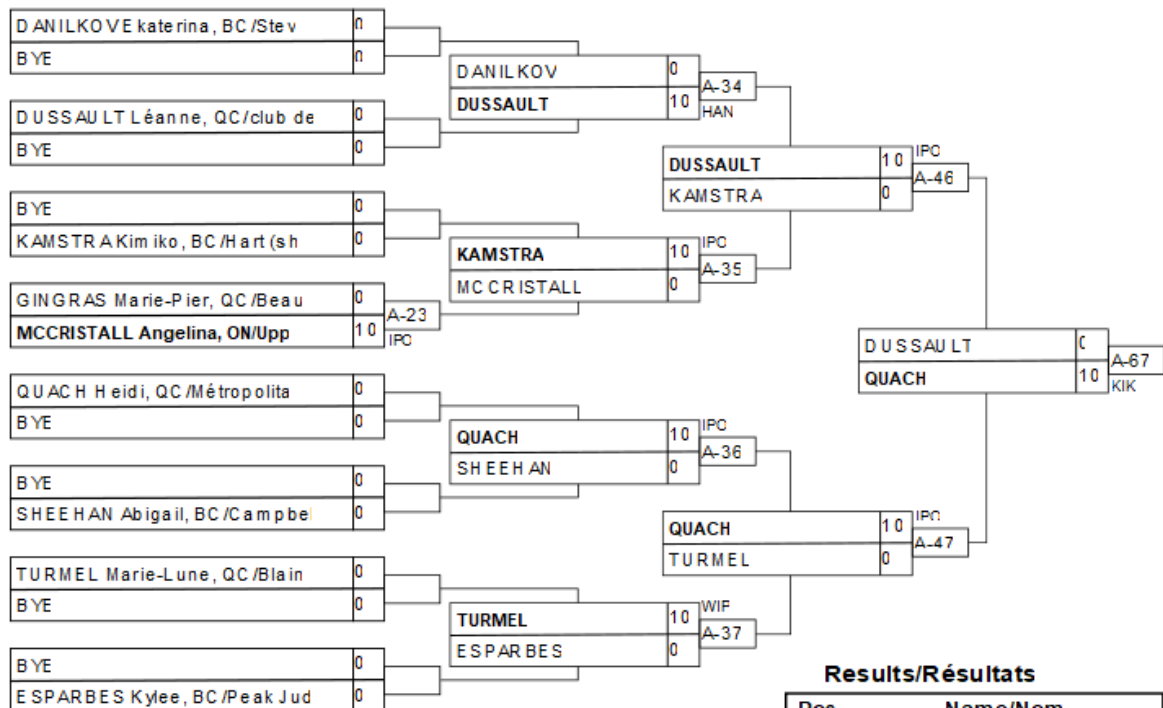

## Results/Résultats

Pos	Name/Nom
1	QUACH Heidi, QC/Métropol
2	DUSSAULT Léanne, QC/club
3	KAMSTRA Kimiko, BC/Hart
3	TURMEL Marie-Lune, QC/BI

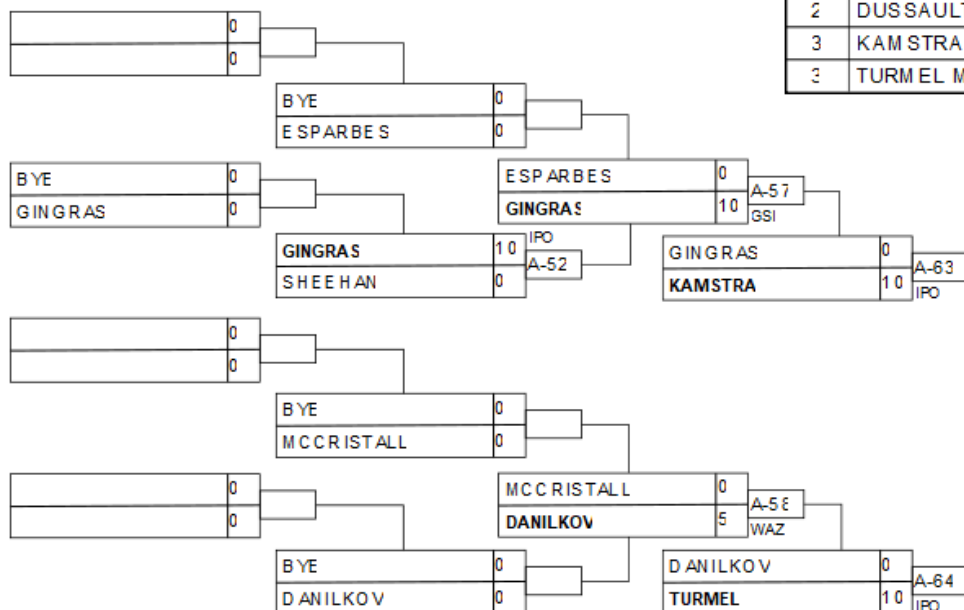





# Senior Female -52kg

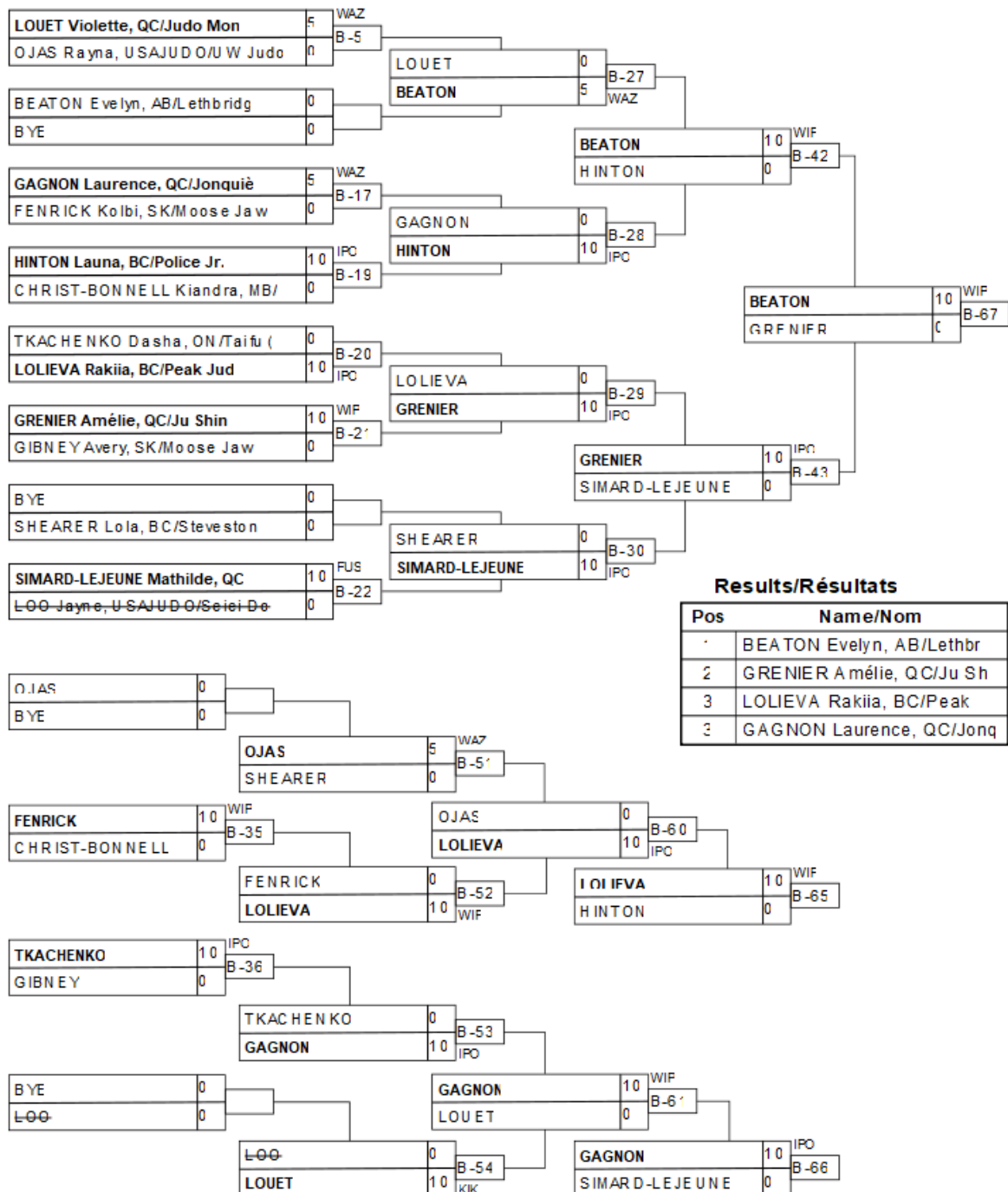



# Senior Female -57kg

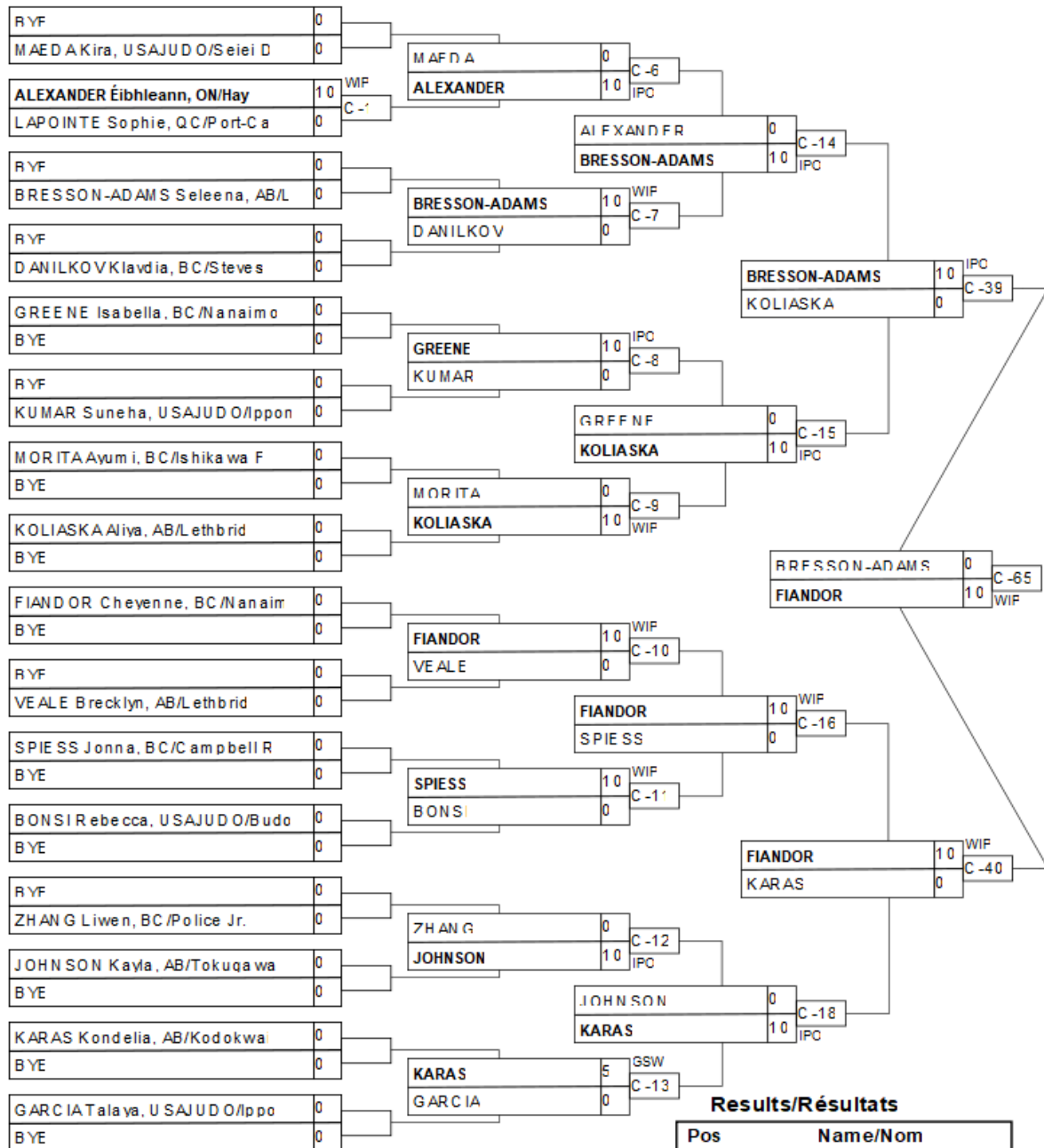

## Results/Résultats

Pos	Name/Nom
1	FIANDOR Cheyenne, BC/Nan
2	BRESSON-ADAMS Seleena, A
3	KOLIASKA Aliya, AB/Lethb
4	ALEXANDER Éibhleann, ON/

# Senior Female -63kg

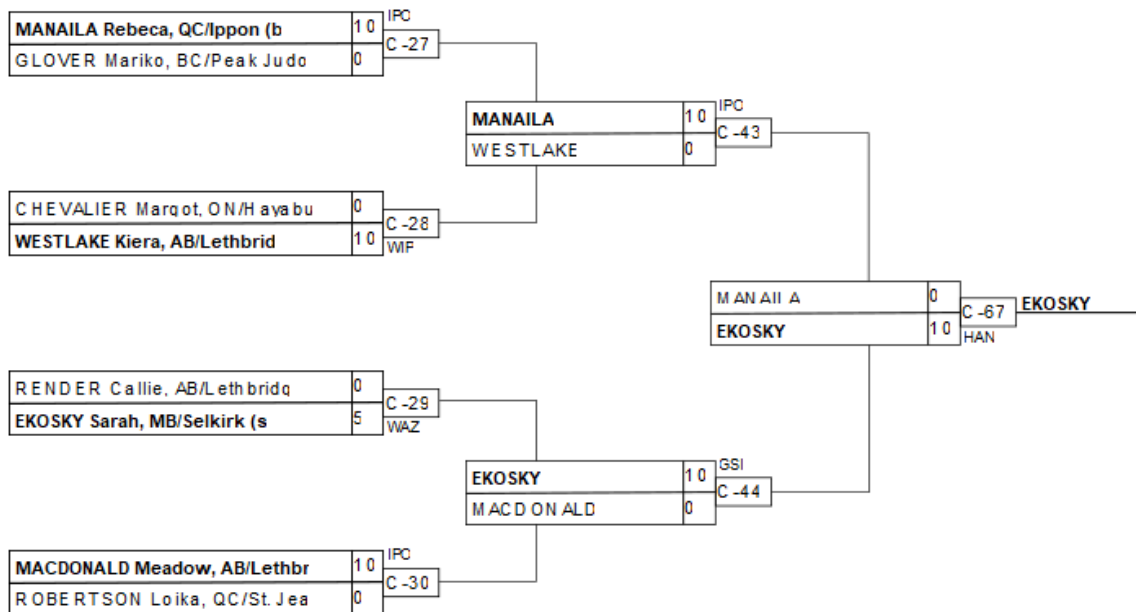

## Results/Résultats

Pos	Name/Nom
1	EKOSKY Sarah, MB/Selkirk
2	MANAILA Rebeca, QC/Ippon
3	WESTLAKE Kiera, AB/Lethb
3	MACDONALD Meadow, AB/Le

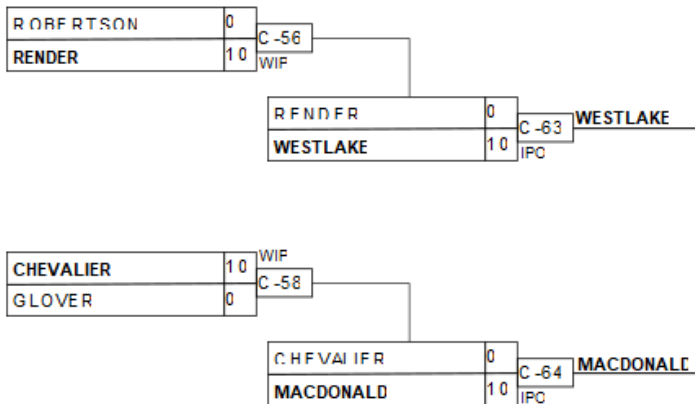

# Senior Female -70kg

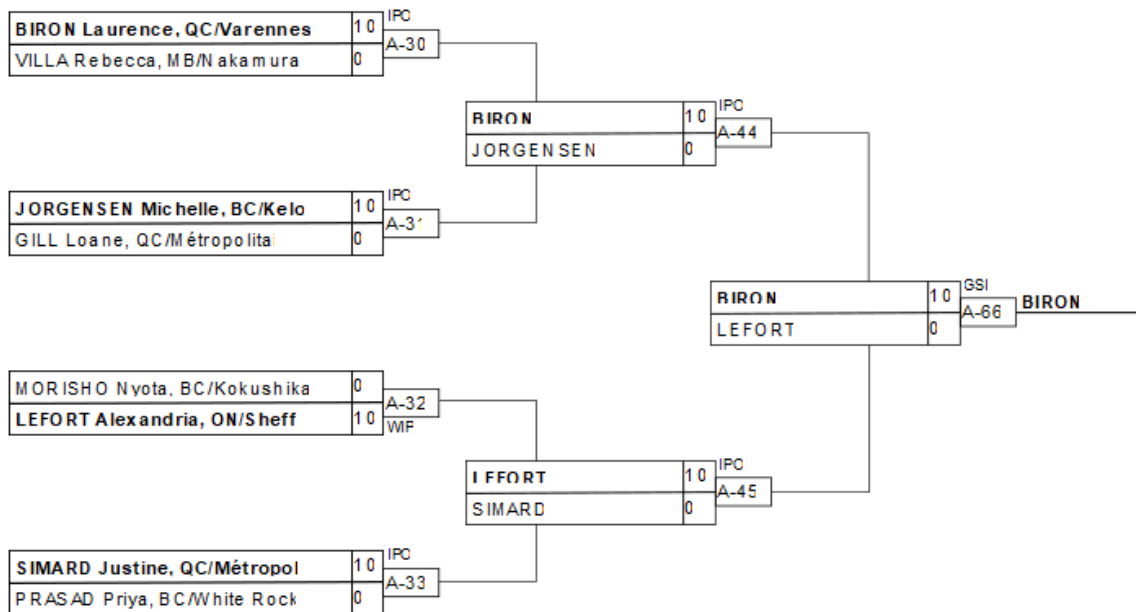

## Results/Résultats

Pos	Name/Nom
1	BIRON Laurence, QC/Varennes
2	LEFORT Alexandria, ON/Sheff
3	MORISHO Nyota, BC/Kokushika
3	SIMARD Justine, QC/Métropolitaine

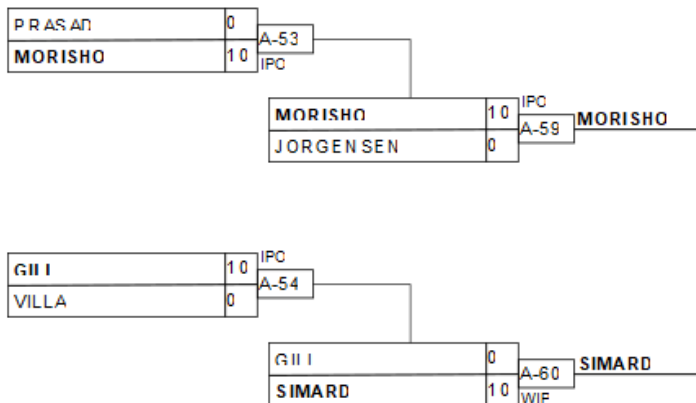



# Senior Female +78kg



## Competitors/Compétiteurs

#	Name/Nom	Grade	Club	1	2	1	2	1	2	W/G	Pts	Pos
1	AUCH Anna	brown	BC/Lake Country	XX		XX		XX		0	0	2
2	KEYS Jannessa	brown	SK/Saskatoon Y	10	XX	10	XX		XX	2	20	1

## Matches/Matches

Match	White/Blanc			Blue/Bleu	Res/Rés	Tim/Tmp	Code
B-41	AUCH Anna	1	2	KEYS Jannessa	0 - 10	1:12	IPO
B-50	KEYS Jannessa	2	1	AUCH Anna	10 - 0	0:07	IPO
B-59	AUCH Anna	1	2	KEYS Jannessa			

## Results/Résultats

Pos	Name/Nom
1	KEYS Jannessa, SK/Saskatoon Y



# Senior Male -100kg



## Competitors/Compétiteurs

#	Name/Nom	Grade	Club	1	2	3	4	W/G	Pts	Pos
1	PAI Brayan	brown	USAJUDO/Budokan Dojo	XX			10	1	10	3
2	AKBASHEV Michael	shodan	MB/BP Judo club	10	XX		10	2	20	2
3	NEYOLOV Danil	nidan	ON/Taifu	10	10	XX	10	3	30	1
4	ROCHELEAU Danick	brown	QC/Métropolitain				XX	0	0	4

## Matches/Matches

Match	White/Blanc			Blue/Bleu	Res/Rés	Tim/Tmp	Code
B-37	PAI Brayan	1	2	AKBASHEV Michael	0 - 10	2:26	WIP
B-38	NEYOLOV Danil	3	4	ROCHELEAU Danick	10 - 0	2:35	IPO
B-44	PAI Brayan	1	3	NEYOLOV Danil	0 - 10	3:04	IPO
B-45	AKBASHEV Michael	2	4	ROCHELEAU Danick	10 - 0	3:15	IPO
B-55	PAI Brayan	1	4	ROCHELEAU Danick	10 - 0	2:17	HAN
B-56	AKBASHEV Michael	2	3	NEYOLOV Danil	0 - 10	4:00	IPO

## Results/Résultats

Pos	Name/Nom
1	NEYOLOV Danil, ON/Taifu
2	AKBASHEV Michael, MB/BP Judo club
3	PAI Brayan, USAJUDO/Budokan Dojo



# Senior Male -60kg

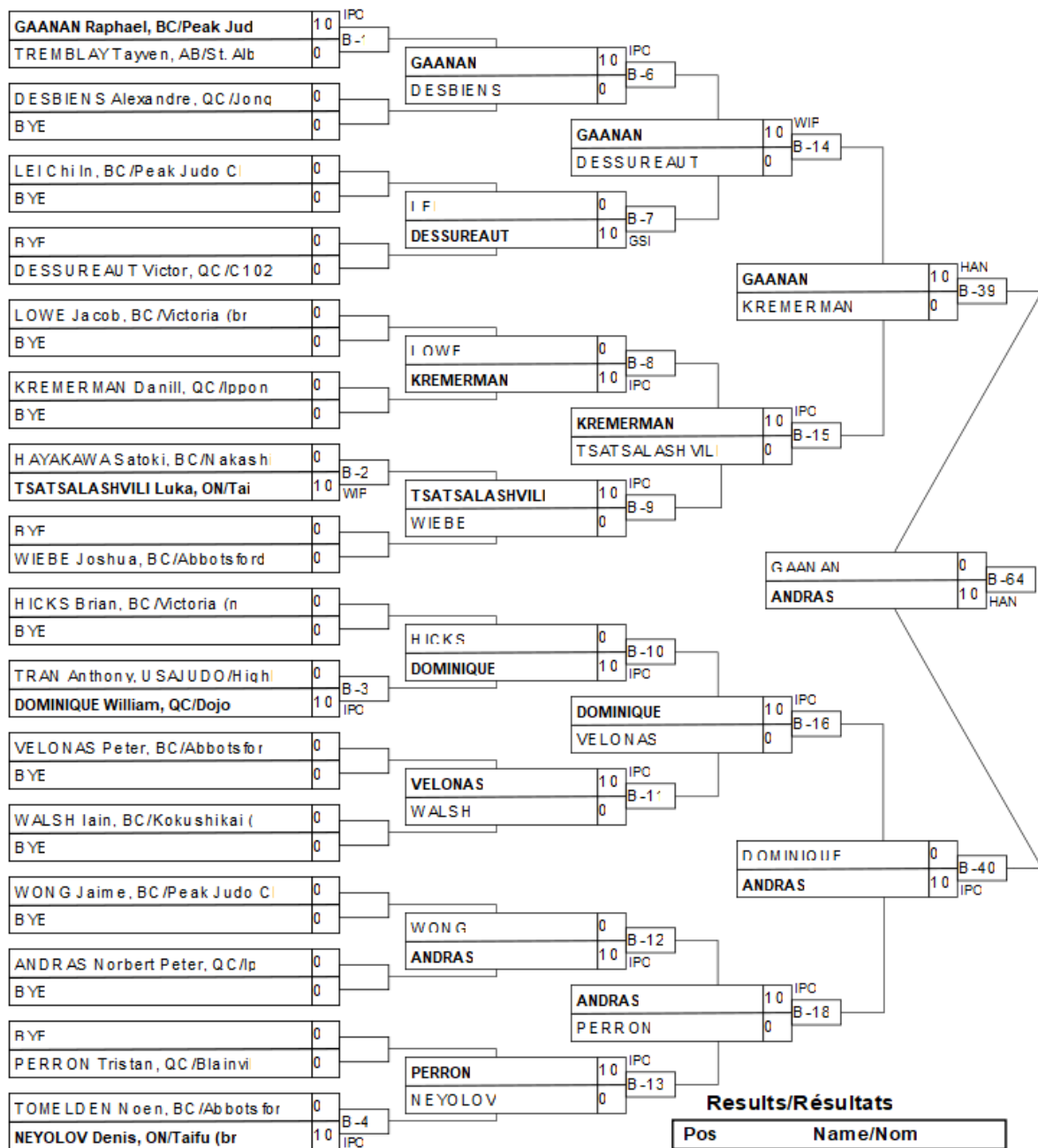

## Results/Résultats

Pos	Name/Nom
1	ANDRAS Norbert Peter, QC
2	GAANAN Raphael, BC/Peak
3	KREMERMAN Danill, QC/Ipp
3	TSATSALASHVILI Luka, ON/



# Senior Male -66kg

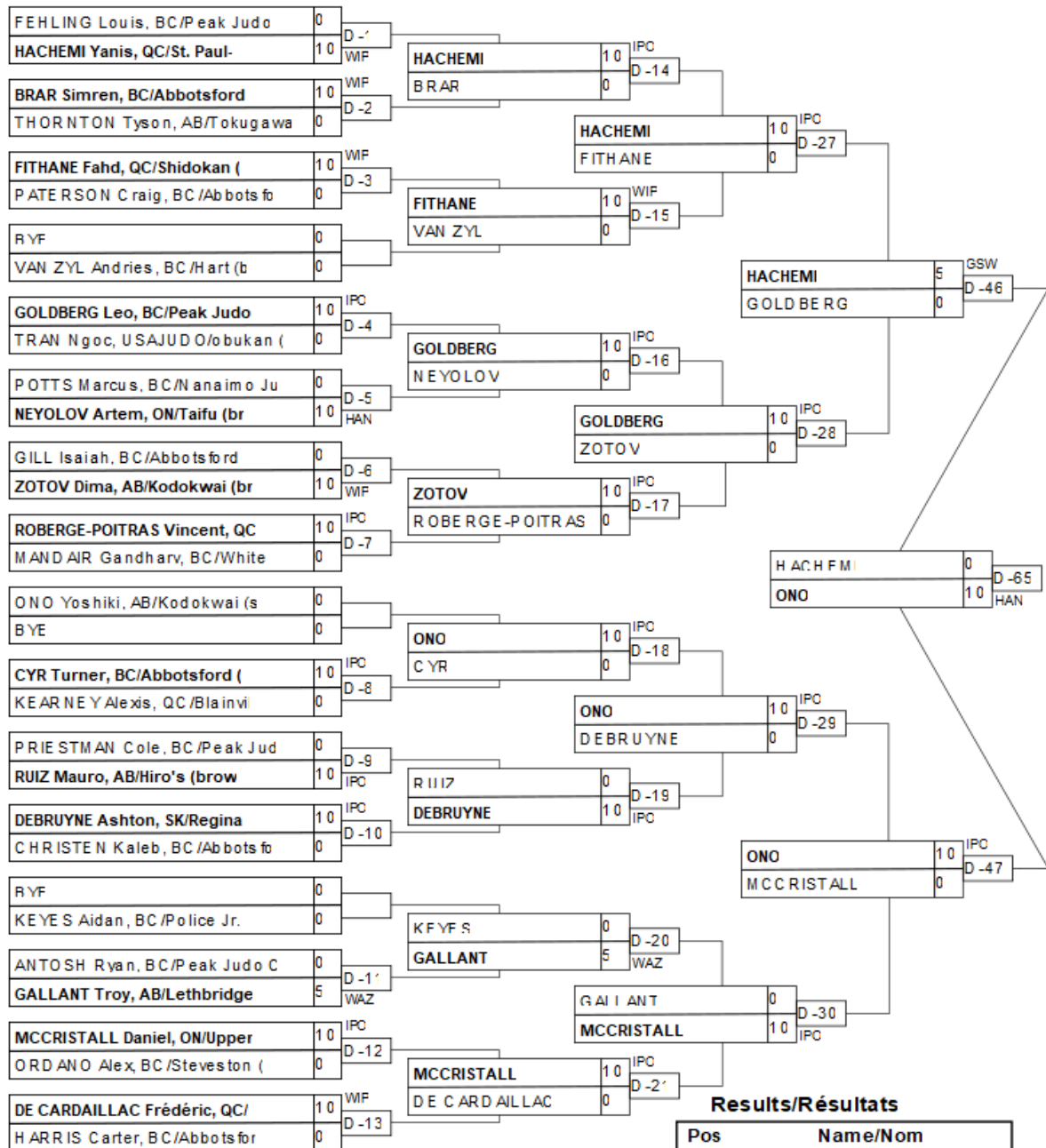

## Results/Résultats

Pos	Name/Nom
1	ONO Yoshiki, AB/Kodokwai
2	HACHEMI Yanis, QC/St. Paul
3	GOLDBERG Leo, BC/Peak Judo
4	MCCRISTALL Daniel, ON/Upper



# Senior Male -73kg

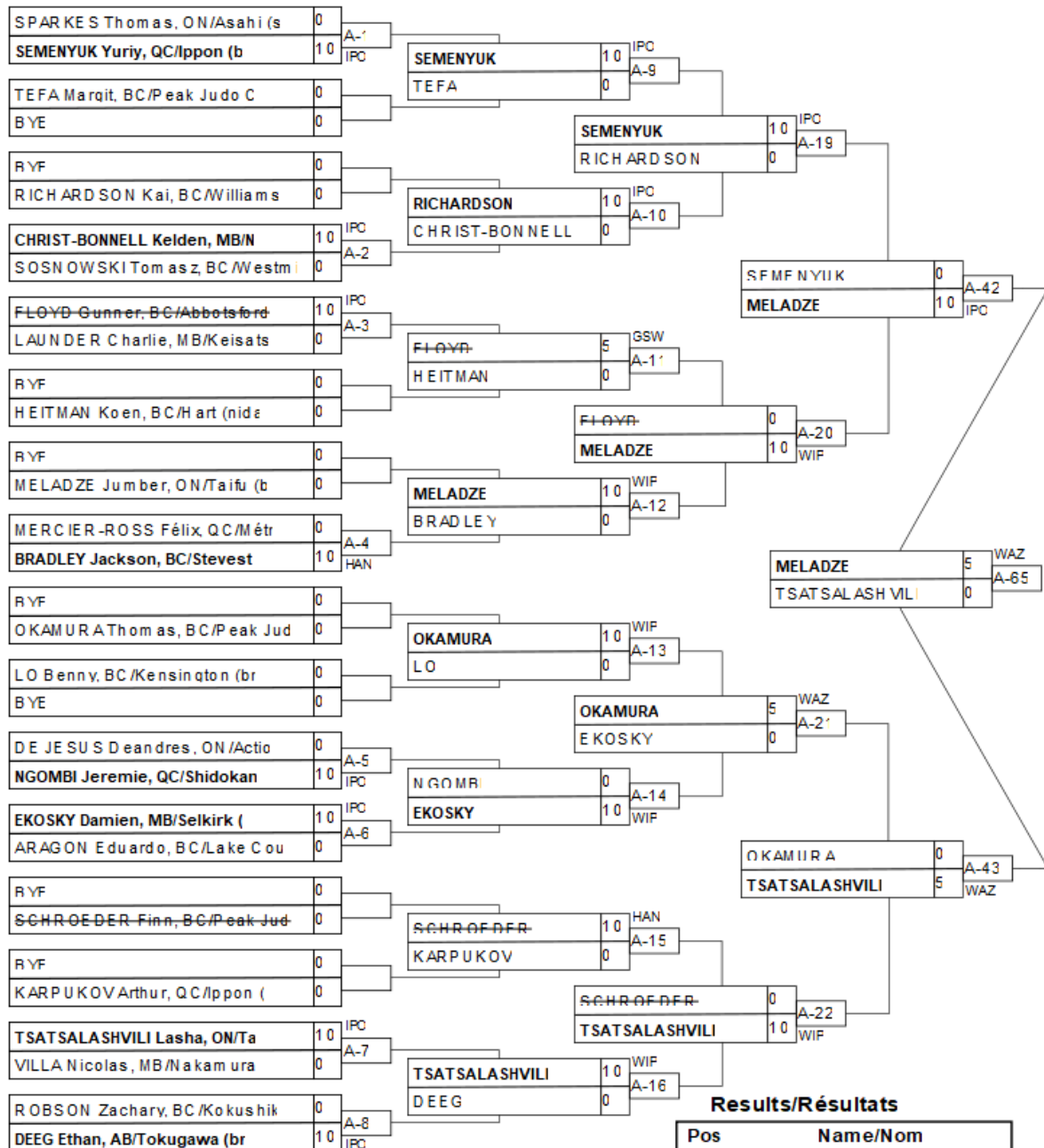

## Results/Résultats

Pos	Name/Nom
1	MELADZE Jumber, ON/Taifu
2	TSATSALASHVILI Lasha, ON
3	SEMENYUK Yuriy, QC/Ippon
4	OKAMURA Thomas, BC/Peak



# Senior Male -81kg

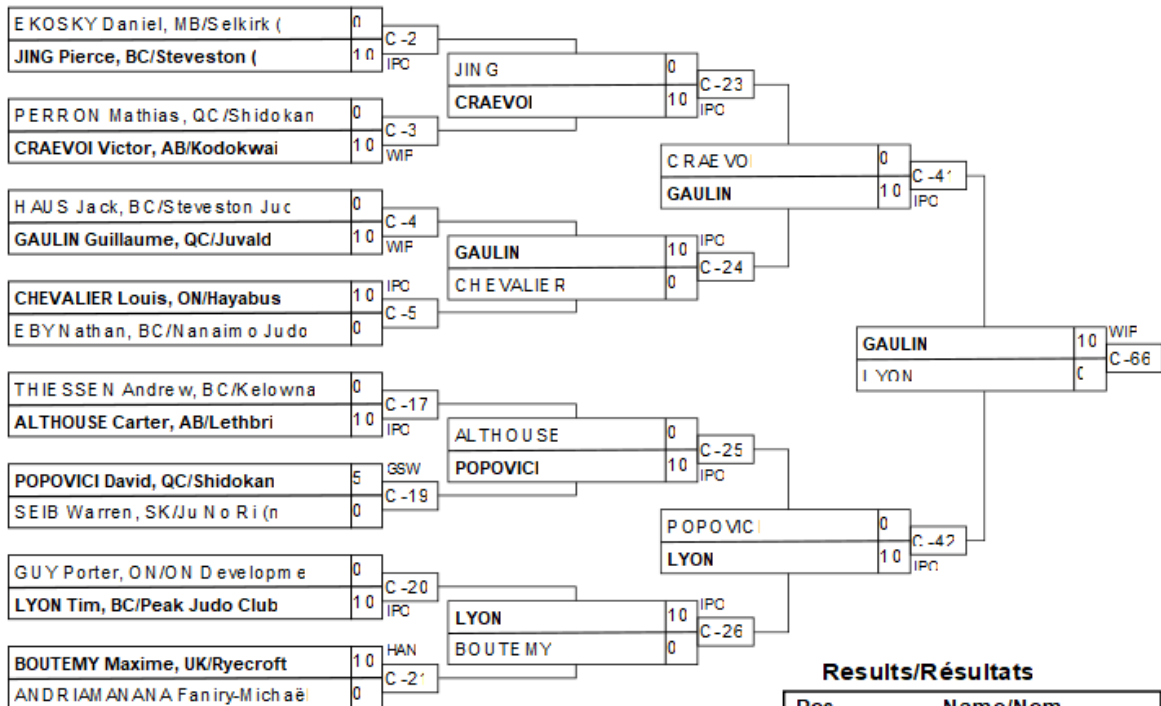

## Results/Résultats

Pos	Name/Nom
1	GAULIN Guillaume, QC/Juv
2	LYON Tim, BC/Peak Judo C
3	BOUTEMY Maxime, UK/Ryecroft
3	SEIB Warren, SK/Ju No Ri

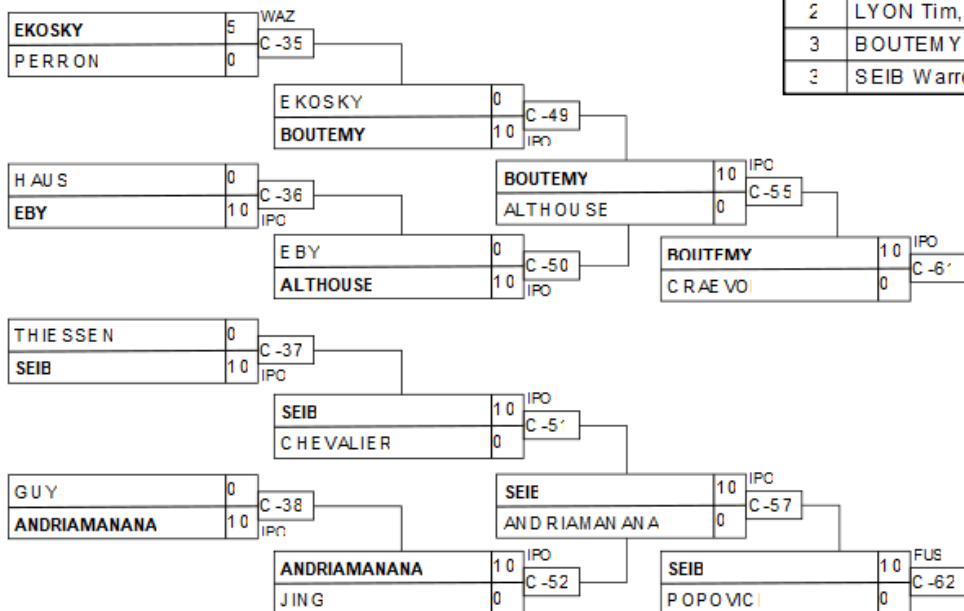



# Senior Male -90kg



## Competitors/Compétiteurs A

#	Name/Nom	Grade	Club	1	2	3	4	W/G	Pts	Pos
1	LEE Hyeok	shodan	BC/Mudo Martial Arts	XX				0	0	4
2	GARAND Alec	brown	QC/Zenshin	10	XX	10	10	3	30	1
3	OGDEN Soren	brown	USAJUDO/Oak Tree Dojo	10		XX	10	2	20	2
4	GODBOUT Xavier	brown	AB/Hiro's	10			XX	1	10	3

## Pool A

Match	White/Blanc	Blue/Bleu	Res/Rés	Tim/Tmp	Code
D-41	LEE Hyeok 1 2	GARAND Alec	0 - 10	1:48	WIP
D-42	OGDEN Soren 3 4	GODBOUT Xavier	10 - 0	2:04	WIP
D-52	LEE Hyeok 1 3	OGDEN Soren	0 - 10	0:00	KIK
D-53	GARAND Alec 2 4	GODBOUT Xavier	10 - 0	1:24	HAN
D-58	LEE Hyeok 1 4	GODBOUT Xavier	0 - 10	0:00	IPO
D-59	GARAND Alec 2 3	OGDEN Soren	10 - 0	4:50	HAN

## Competitors/Compétiteurs B

#	Name/Nom	Grade	Club	5	6	7	W/G	Pts	Pos
5	MILADINOVIC Djuro	shodan	BC/Nakashima	XX			0	0	3
6	NICKMANESH Reza	shodan	BC/Kensington	10	XX	10	2	20	1
7	COFFMAN Sean	brown	USAJUDO/Northsound Judo Club	10		XX	1	10	2

## Pool B

Match	White/Blanc	Blue/Bleu	Res/Rés	Tim/Tmp	Code
D-43	MILADINOVIC Djuro 5 6	NICKMANESH Reza	0 - 10	0:13	IPO
D-54	MILADINOVIC Djuro 5 7	COFFMAN Sean	0 - 10	3:57	IPO
D-60	NICKMANESH Reza 6 7	COFFMAN Sean	10 - 0	0:36	IPO

### GARAND

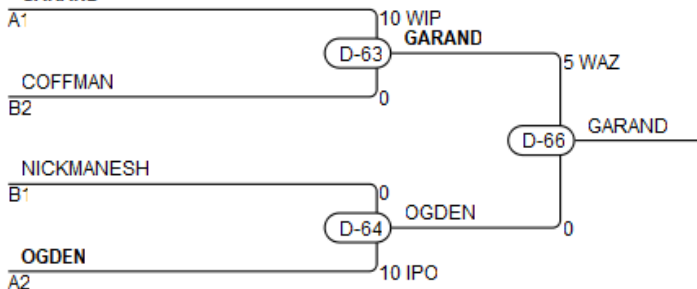

## Results/Résultats

Pos	Name/Nom
1	GARAND Alec, QC/Zenshin
2	OGDEN Soren, USAJUDO/Oak Tree Dojo
3	COFFMAN Sean, USAJUDO/Northsound Judo Club
3	NICKMANESH Reza, BC/Kensington



# U16 Female -48kg

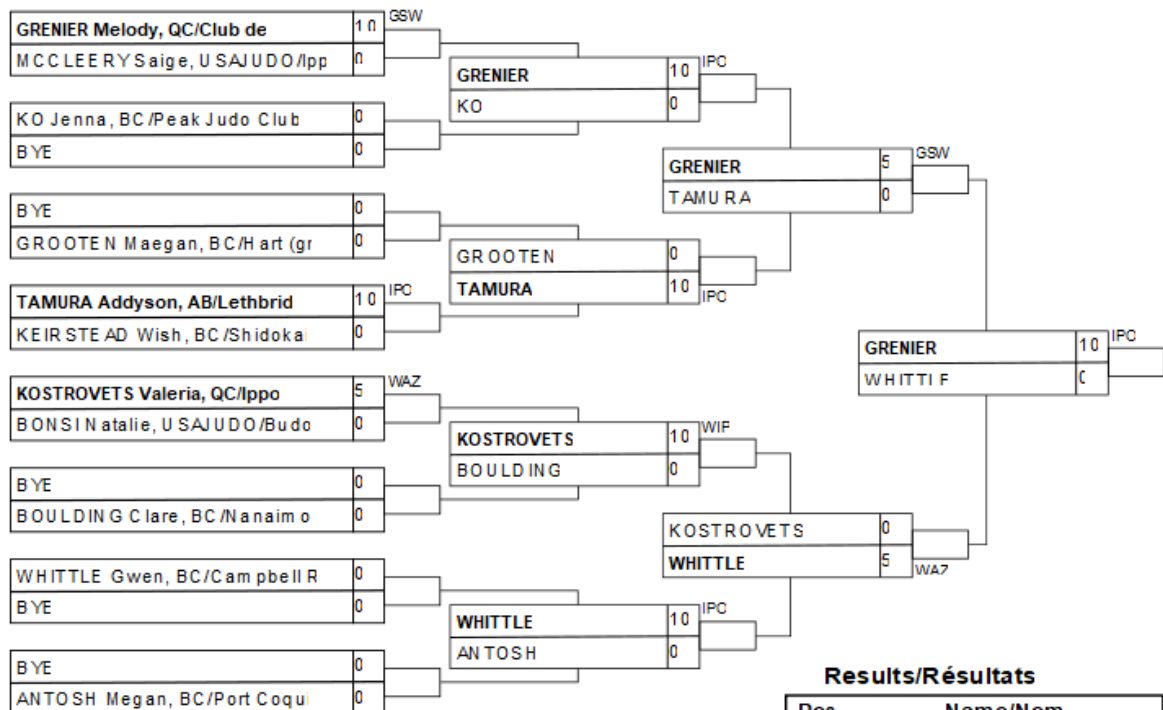

## Results/Résultats

Pos	Name/Nom
1	GRENIER Melody, QC/Club
2	WHITTLE Gwen, BC/Campbell
3	MCCLEERY Saige, USAJUDO
3	KO Jenna, BC/Peak Judo C

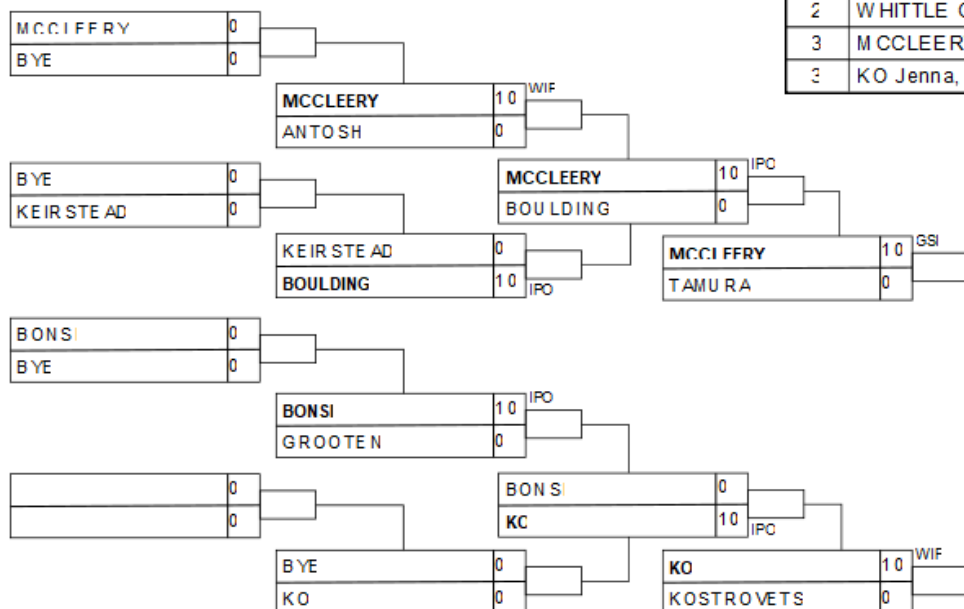



# U16 Female -52kg

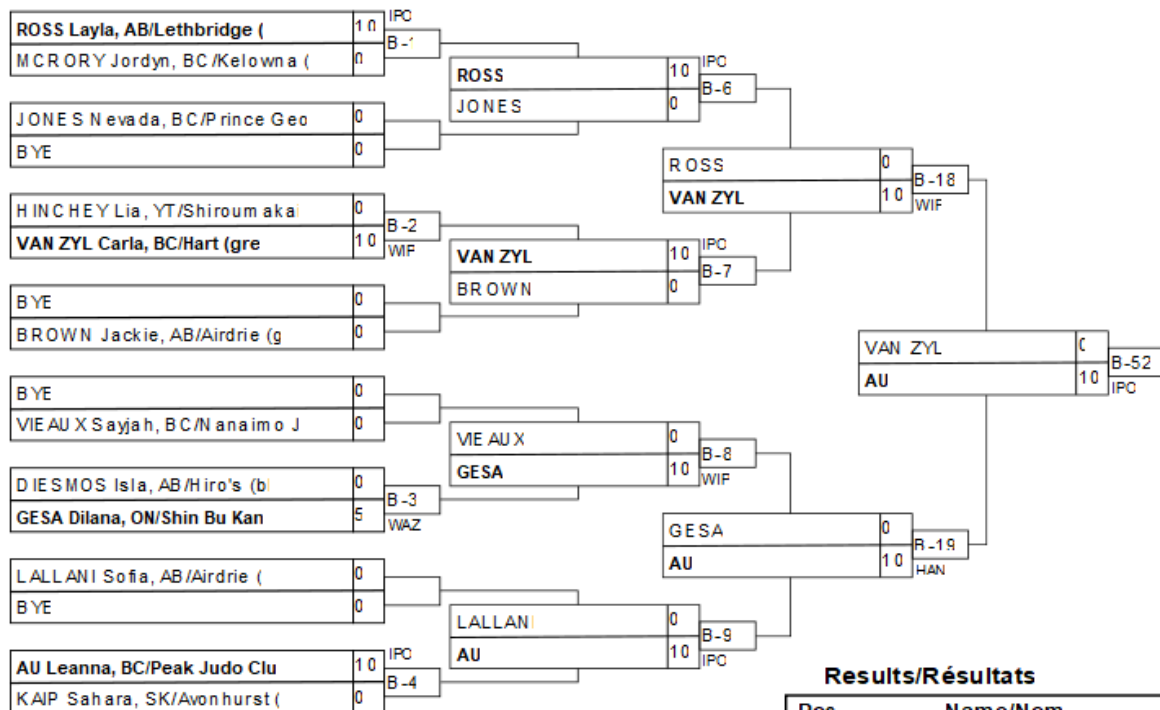

## Results/Résultats

Pos	Name/Nom
1	AU Leanna, BC/Peak Judo
2	VAN ZYL Carla, BC/Hart (
3	HINCHEY Lia, Y T/S hirouma
3	GESA Dilana, ON/Shin Bu





# U16 Female -63kg

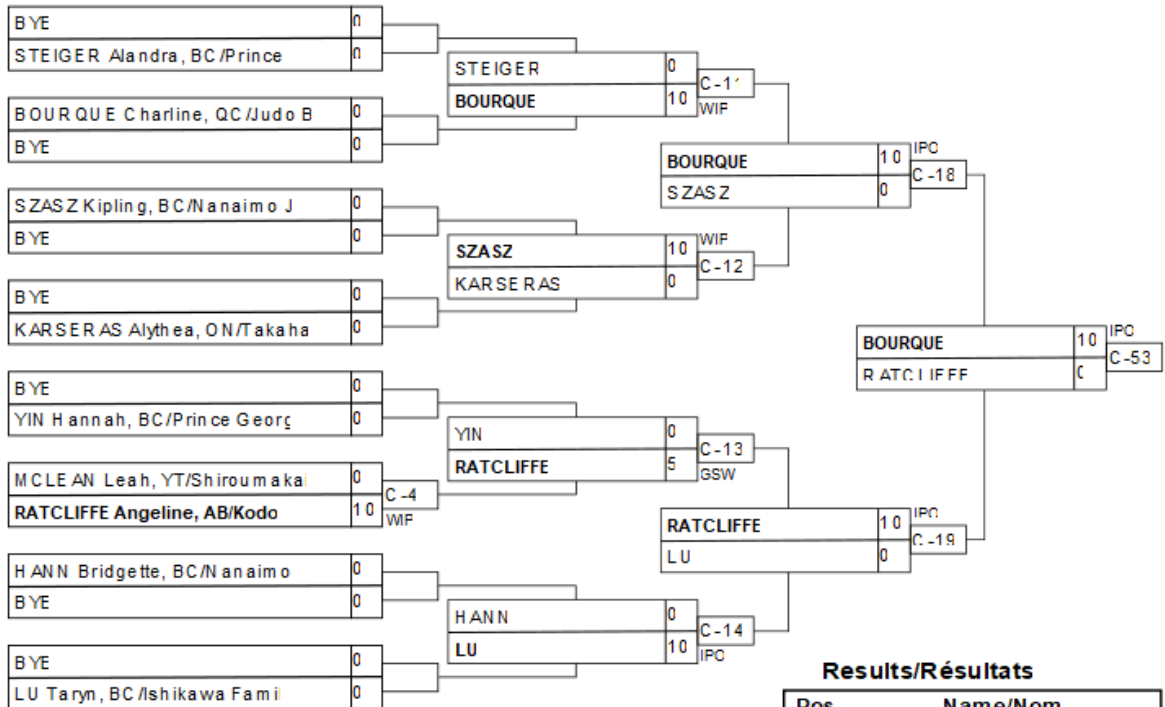

## Results/Résultats

Pos	Name/Nom
1	BOURQUE Charline, QC/Jud
2	RATCLIFFE Angeline, AB/K
3	YIN Hannah, BC/Prince Ge
3	STEIGER Alandra, BC/Prin

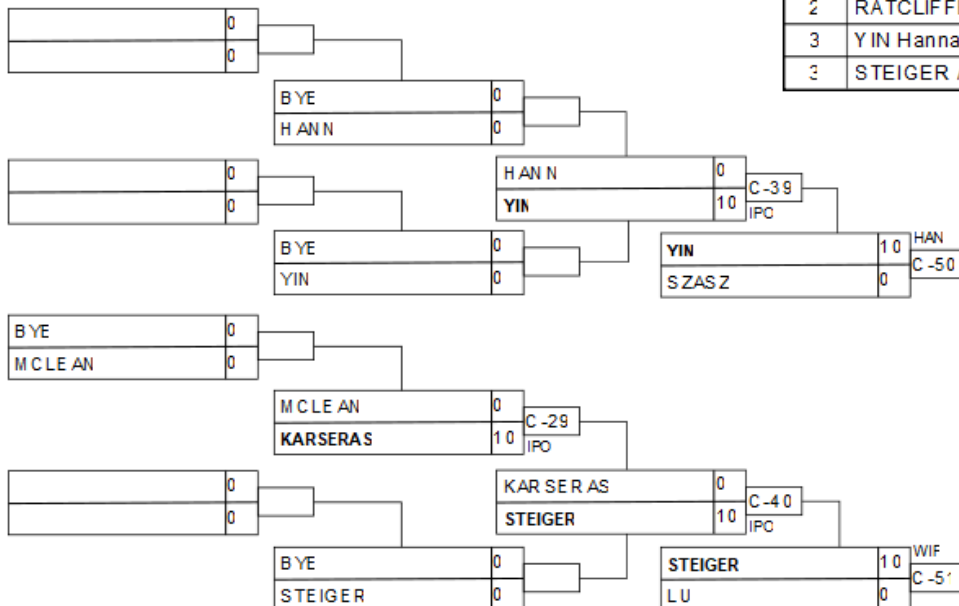



# U16 Female -70kg



## Competitors/Compétiteurs A

#	Name/Nom	Grade	Club	1	2	3	4	W/G	Pts	Pos
1	BONIFACIO Kaiya	blue	USAJUDO/Budokan Dojo	XX	10	10	10	3	30	1
2	ALIYEVA Emiliya	green	AB/Hiro's		XX	10		1	10	3
3	BOWDEN Trinity	green	BC/White Rock			XX		0	0	4
4	MCCULLOUGH Lily	blue	BC/Prince George		10	10	XX	2	20	2

## Pool A

Match	White/Blanc	Blue/Bleu	Res/Rés	Tim/Tmp	Code
A-17	BONIFACIO Kaiya 1 2	ALIYEVA Emiliya	10 - 0	0:25	IPO
A-18	BOWDEN Trinity 3 4	MCCULLOUGH Lily	0 - 10	0:41	WIP
A-27	BONIFACIO Kaiya 1 3	BOWDEN Trinity	10 - 0	0:33	IPO
A-28	ALIYEVA Emiliya 2 4	MCCULLOUGH Lily	0 - 10	2:22	IPO
A-39	BONIFACIO Kaiya 1 4	MCCULLOUGH Lily	10 - 0	3:00	GSI
A-40	ALIYEVA Emiliya 2 3	BOWDEN Trinity	10 - 0	0:40	IPO

## Competitors/Compétiteurs B

#	Name/Nom	Grade	Club	5	6	7	W/G	Pts	Pos
5	BOWDEN Savannah	green	BC/White Rock	XX			0	0	3
6	LITCHFIELD Isabel	green	AB/Barracuda	10	XX		1	10	2
7	GALLANT Madison	blue	AB/Lethbridge	10	10	XX	2	20	1

## Pool B

Match	White/Blanc	Blue/Bleu	Res/Rés	Tim/Tmp	Code
A-19	BOWDEN Savannah 5 6	LITCHFIELD Isabel	0 - 10	1:54	IPO
A-29	BOWDEN Savannah 5 7	GALLANT Madison	0 - 10	1:06	IPO
A-41	LITCHFIELD Isabel 6 7	GALLANT Madison	0 - 10	0:00	IPO

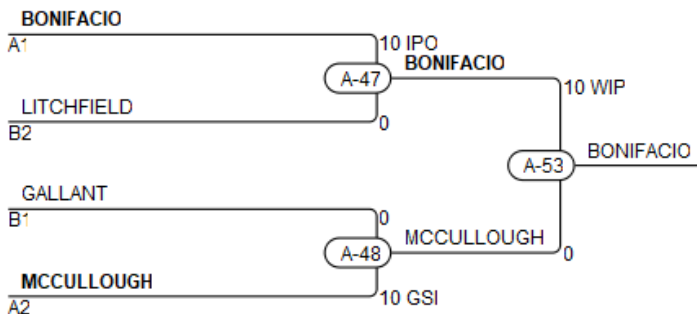

## Results/Résultats

Pos	Name/Nom
1	BONIFACIO Kaiya, USAJUDO/Budokan Dojo
2	MCCULLOUGH Lily, BC/Prince George
3	LITCHFIELD Isabel, AB/Barracuda
3	GALLANT Madison, AB/Lethbridge





# U16 Male -38kg



## Competitors/Compétiteurs

#	Name/Nom	Grade	Club	1	2	3	W/G	Pts	Pos
1	HILLMAN Jackson	green/blue	BC/Abbotsford	XX			0	0	3
2	LOLIEV Akhmed	green/blue	BC/Peak Judo Club	10	XX		1	10	2
3	SEMYROZUM Roman	green/blue	QC/Ippon	10	10	XX	2	20	1

## Matches/Matches

Match	White/Blanc			Blue/Bleu	Res/Rés	Tim/Tmp	Code
B-26	HILLMAN Jackson	1	2	LOLIEV Akhmed	0 - 10	3:39	GSI
B-36	HILLMAN Jackson	1	3	SEMYROZUM Roman	0 - 10	0:00	WIP
B-45	LOLIEV Akhmed	2	3	SEMYROZUM Roman	0 - 10	2:27	IPO

## Results/Résultats

Pos	Name/Nom
1	SEMYROZUM Roman, QC/Ippon
2	LOLIEV Akhmed, BC/Peak Judo Club



# U16 Male -42kg



## Competitors/Compétiteurs

#	Name/Nom	Grade	Club	1	2	3	4	5	W/G	Pts	Pos
1	NELSON Paxton	blue	SK/Avonhurst	XX		5	10	5	3	20	3
2	ROBERGE-POITRAS Samuel	blue	QC/Baie-Comeau	5	XX		10	10	3	25	2
3	ROITMAN Arel	green/blue	ON/Taifu		10	XX	10	10	3	30	1
4	HINTON Tobin	green/blue	BC/Police Jr.				XX	10	1	10	4
5	KO Logan	green	BC/Peak Judo Club					XX	0	0	5

## Matches/Matches

Match	White/Blanc			Blue/Bleu	Res/Rés	Tim/Tmp	Code
A-9	HINTON Tobin	4	5	KO Logan	10 - 0	2:21	IPO
A-10	NELSON Paxton	1	2	ROBERGE-POITRAS Samuel	0 - 5	5:02	GSW
A-15	ROITMAN Arel	3	4	HINTON Tobin	10 - 0	1:41	IPO
A-16	NELSON Paxton	1	5	KO Logan	5 - 0	3:00	WAZ
A-25	ROBERGE-POITRAS Samuel	2	3	ROITMAN Arel	0 - 10	5:26	GSI
A-26	NELSON Paxton	1	4	HINTON Tobin	10 - 0	0:44	IPO
A-37	ROITMAN Arel	3	5	KO Logan	10 - 0	2:25	IPO
A-38	ROBERGE-POITRAS Samuel	2	4	HINTON Tobin	10 - 0	2:38	IPO
A-49	NELSON Paxton	1	3	ROITMAN Arel	5 - 0	3:00	WAZ
A-50	ROBERGE-POITRAS Samuel	2	5	KO Logan	10 - 0	0:28	WIP

## Results/Résultats

Pos	Name/Nom
1	ROITMAN Arel, ON/Taifu
2	ROBERGE-POITRAS Samuel, QC/Baie-Comeau
3	NELSON Paxton, SK/Avonhurst
4	HINTON Tobin, BC/Police Jr.



# U16 Male -46kg



## Competitors/Compétiteurs

#	Name/Nom	Grade	Club	1	2	3	4	5	W/G	Pts	Pos
1	PAMPOLINA Avery	green	MB/Nakamura	XX			10	5	2	15	3
2	TALBOT Machiel	blue	QC/Baie-Comeau	10	XX	5	10		3	25	2
3	WEBBER Justin	blue	AB/Hiro's	10		XX			1	10	5
4	MOES Ezekiel	green/blue	BC/Nanaimo Judo Club			10	XX		1	10	4
5	TEMIRBAEV Amir	green/blue	BC/Peak Judo Club		10	10	10	XX	3	30	1

## Matches/Matches

Match	White/Blanc		Blue/Bleu	Res/Rés	Tim/Tmp	Code	
1	MOES Ezekiel	4	5	TEMIRBAEV Amir	0 - 10	0:14	IPO
2	PAMPOLINA Avery	1	2	TALBOT Machiel	0 - 10	1:15	IPO
3	WEBBER Justin	3	4	MOES Ezekiel	0 - 10	0:25	IPO
4	PAMPOLINA Avery	1	5	TEMIRBAEV Amir	5 - 0	3:46	GSW
5	TALBOT Machiel	2	3	WEBBER Justin	5 - 0	3:12	GSW
6	PAMPOLINA Avery	1	4	MOES Ezekiel	10 - 0	0:45	IPO
7	WEBBER Justin	3	5	TEMIRBAEV Amir	0 - 10	2:18	WIP
8	TALBOT Machiel	2	4	MOES Ezekiel	10 - 0	3:20	GSW
9	PAMPOLINA Avery	1	3	WEBBER Justin	0 - 10	2:46	HAN
10	TALBOT Machiel	2	5	TEMIRBAEV Amir	0 - 10	0:56	IPO

## Results/Résultats

Pos	Name/Nom
1	TEMIRBAEV Amir, BC/Peak Judo Club
2	TALBOT Machiel, QC/Baie-Comeau
3	PAMPOLINA Avery, MB/Nakamura
4	MOES Ezekiel, BC/Nanaimo Judo Club



# U16 Male -50kg

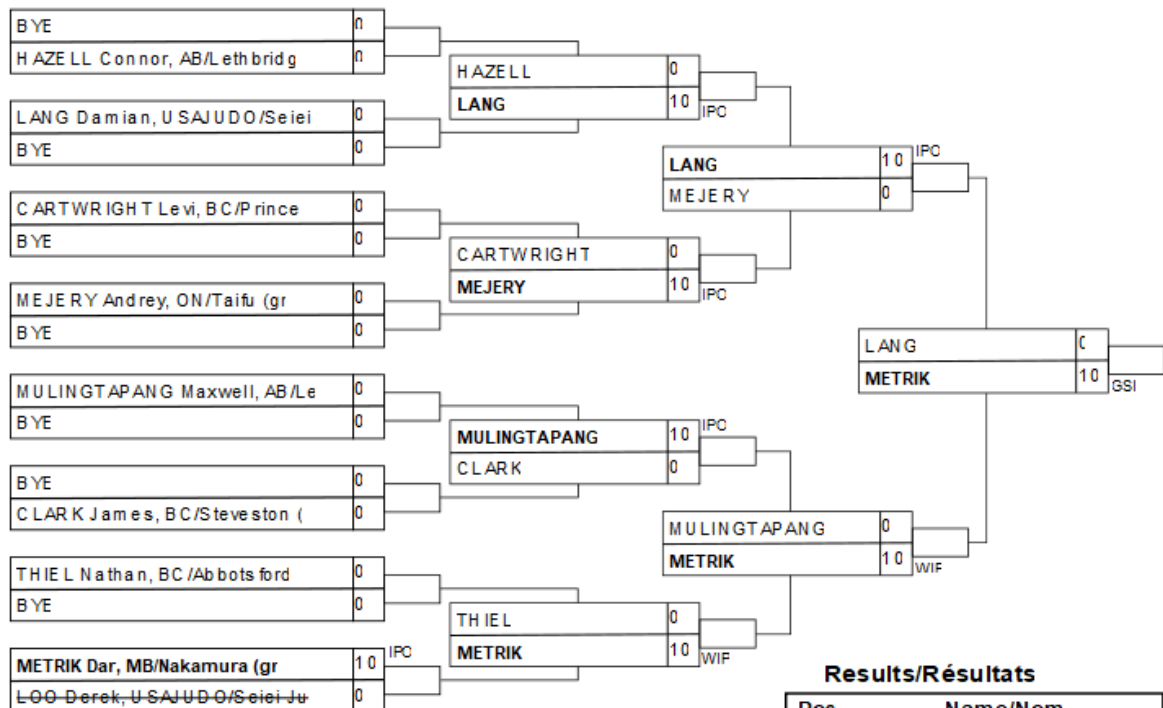

## Results/Résultats

Pos	Name/Nom
1	METRIK Dar, MB/Nakamura
2	LANG Damian, USAJUDO/Sei
3	THIEL Nathan, B C/Abbotsford
3	MULINGTAPANG Maxwell, AB

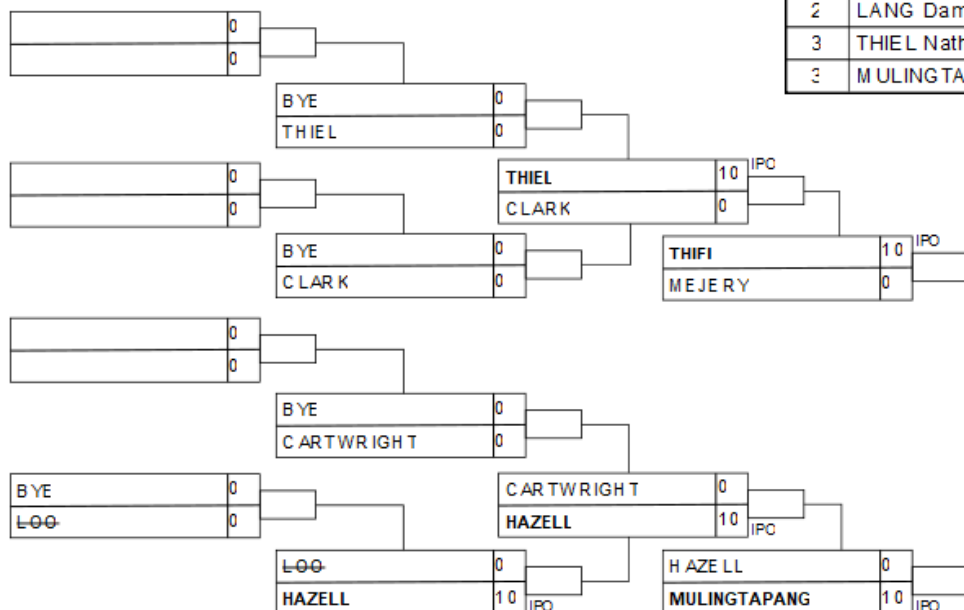



# U16 Male -55kg

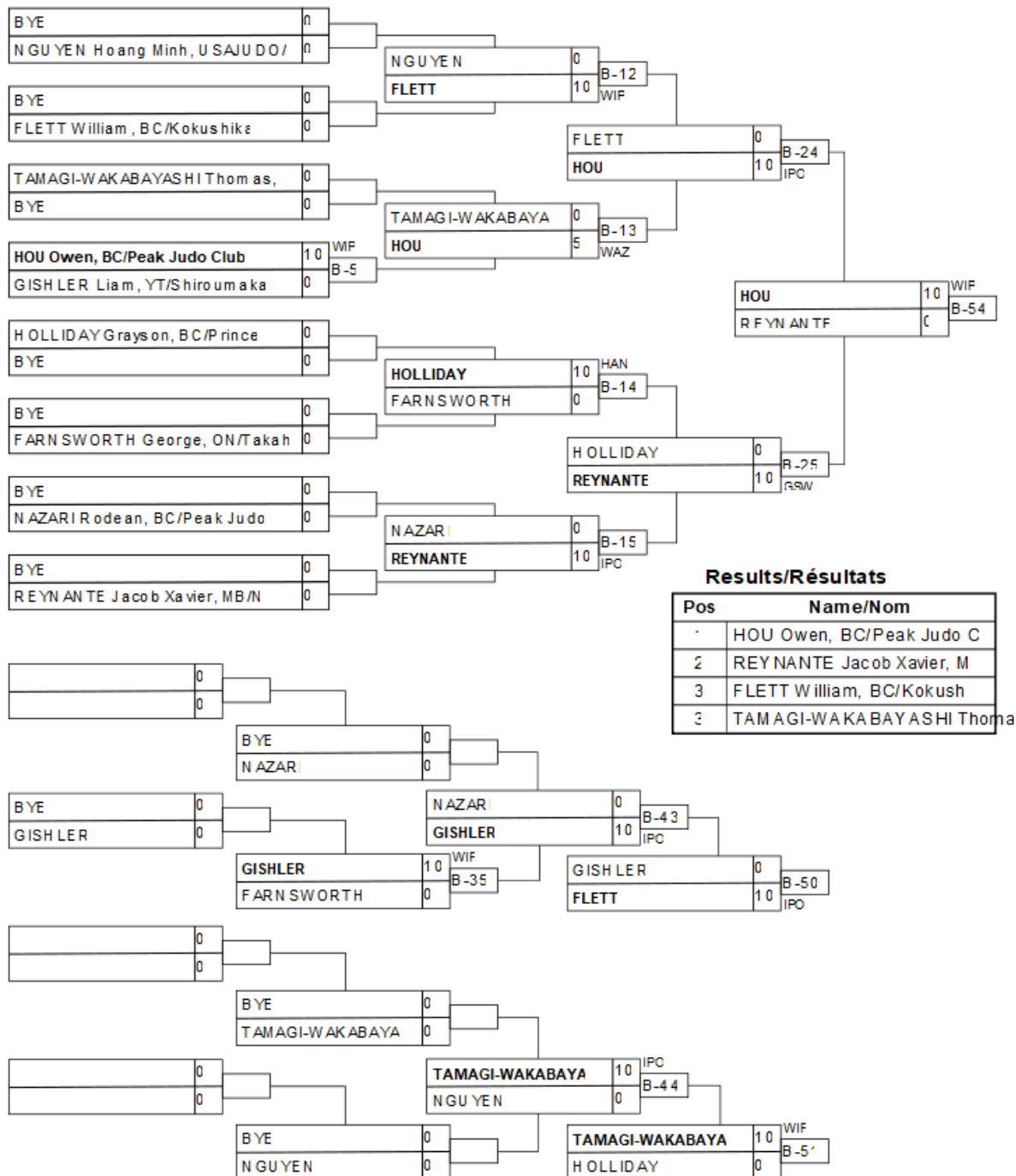



# U16 Male -60kg

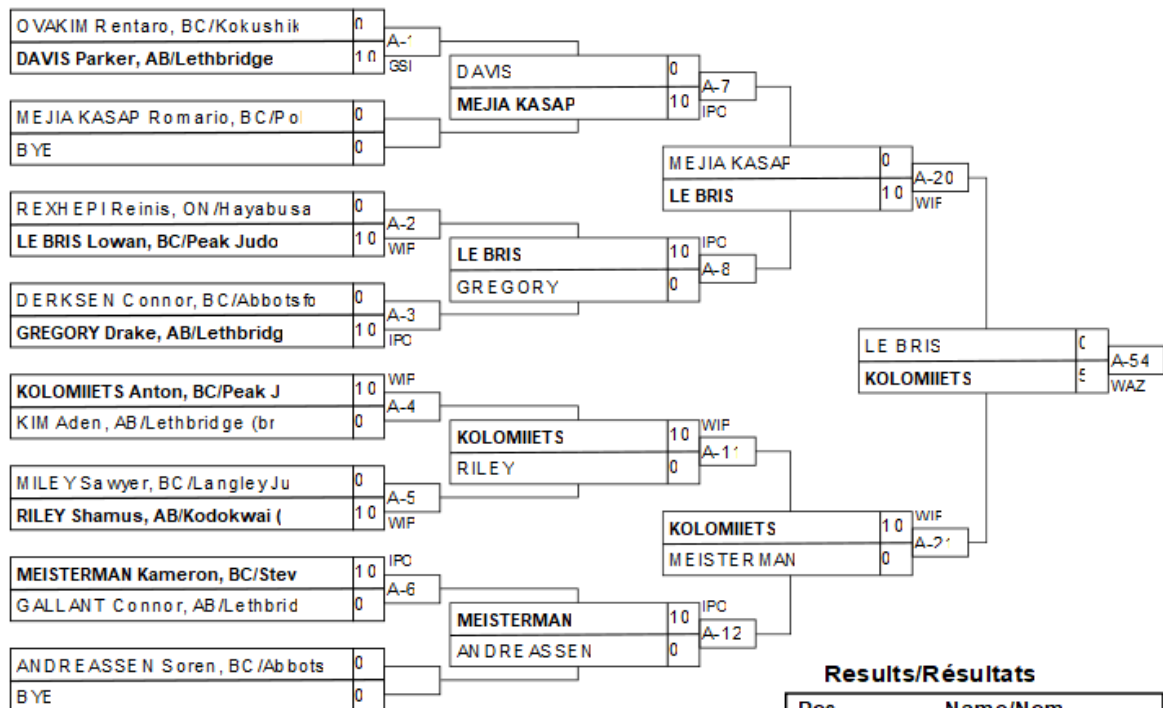

## Results/Résultats

Pos	Name/Nom
1	KOLOMIETS Anton, BC/Pea
2	LE BRIS Lowan, BC/Peak J
3	REXHEPI Reinis, ON/Hayab
3	GALLANT Connor, AB/Letht

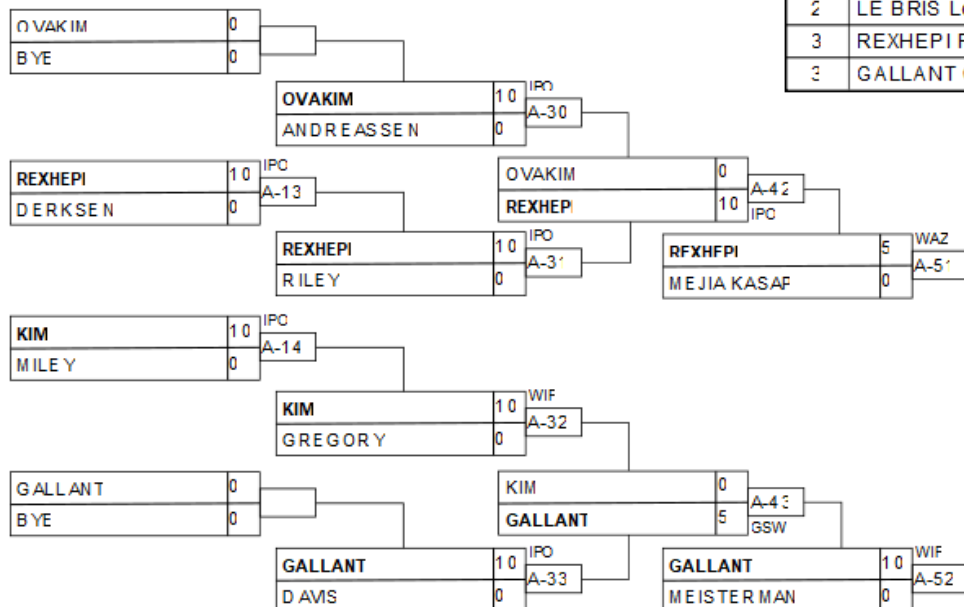



# U16 Male -66kg



## Competitors/Compétiteurs A

#	Name/Nom	Grade	Club	1	2	3	W/G	Pts	Pos
1	DZHABRAILOV Zubail	blue	AB/Tolide	XX	10		1	10	2
2	KRUGER John	green/blue	BC/Nanaimo		XX		0	0	3
3	HARRIS Zachary	brown	BC/Abbotsford	10	10	XX	2	20	1

## Pool A

Match	White/Blanc	Blue/Bleu	Res/Rés	Tim/Tmp	Code
B-20	DZHABRAILOV Zubail 1 2	KRUGER John	10 - 0	0:57	IPO
B-33	DZHABRAILOV Zubail 1 3	HARRIS Zachary	0 - 10	0:05	IPO
B-41	KRUGER John 2 3	HARRIS Zachary	0 - 10	2:12	IPO

## Competitors/Compétiteurs B

#	Name/Nom	Grade	Club	4	5	6	W/G	Pts	Pos
4	TANAKA SVERZUT Diego	green	BC/Police Jr.	XX	5		1	5	2
5	COUGHLAN Silas	blue	AB/Hiro's		XX		0	0	3
6	ZELENKA Rayden	blue	ON/Ajax Budokan	10	10	XX	2	20	1

## Pool B

Match	White/Blanc	Blue/Bleu	Res/Rés	Tim/Tmp	Code
B-21	TANAKA SVERZUT Diego 4 5	COUGHLAN Silas	5 - 0	3:34	GSW
B-34	TANAKA SVERZUT Diego 4 6	ZELENKA Rayden	0 - 10	0:35	WIP
B-42	COUGHLAN Silas 5 6	ZELENKA Rayden	0 - 10	0:58	IPO

HARRIS

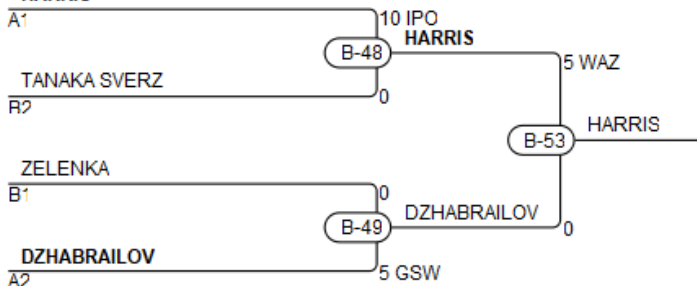

## Results/Résultats

Pos	Name/Nom
1	HARRIS Zachary, BC/Abbotsford
2	DZHABRAILOV Zubail, AB/Tolide
3	TANAKA SVERZUT Diego, BC/Police Jr.
3	ZELENKA Rayden, ON/Ajax Budokan



# U16 Male -73kg



## Competitors/Compétiteurs

#	Name/Nom	Grade	Club	1	2	3	4	5	W/G	Pts	Pos
1	HOOVER Owen	green	AB/Kodokwai	XX					0	0	5
2	ALTHOUSE Sawyer	brown	AB/Lethbridge	10	XX	10	10	10	4	40	1
3	SOKOLOV Elisey	blue	ON/Taifu	10		XX		10	2	20	3
4	YUN Matthew	blue	BC/Champion	10		10	XX	10	3	30	2
5	WHITMORE Gavin	brown	BC/Abbotsford	5				XX	1	5	4

## Matches/Matches

Match	White/Blanc		Blue/Bleu	Res/Rés	Tim/Tmp	Code	
1	<b>YUN Matthew</b>	4	5	WHITMORE Gavin	10 - 0	1:14	WIP
2	HOOVER Owen	1	2	<b>ALTHOUSE Sawyer</b>	0 - 10	1:08	WIP
3	SOKOLOV Elisey	3	4	<b>YUN Matthew</b>	0 - 10	6:46	GSI
4	HOOVER Owen	1	5	<b>WHITMORE Gavin</b>	0 - 5	3:00	WAZ
5	<b>ALTHOUSE Sawyer</b>	2	3	SOKOLOV Elisey	10 - 0	4:26	HAN
6	HOOVER Owen	1	4	<b>YUN Matthew</b>	0 - 10	0:39	WIP
7	<b>SOKOLOV Elisey</b>	3	5	WHITMORE Gavin	10 - 0	0:28	IPO
8	<b>ALTHOUSE Sawyer</b>	2	4	YUN Matthew	10 - 0	3:16	GSI
9	HOOVER Owen	1	3	<b>SOKOLOV Elisey</b>	0 - 10	1:29	WIP
10	<b>ALTHOUSE Sawyer</b>	2	5	WHITMORE Gavin	10 - 0	2:48	IPO

## Results/Résultats

Pos	Name/Nom
1	ALTHOUSE Sawyer, AB/Lethbridge
2	YUN Matthew, BC/Champion
3	SOKOLOV Elisey, ON/Taifu
4	WHITMORE Gavin, BC/Abbotsford





# U16 Male +73kg



## Competitors/Compétiteurs

#	Name/Nom	Grade	Club	1	2	3	4	W/G	Pts	Pos
1	BOUCHARD Jean-David	brown	QC/Fermont	XX	10	10	10	3	30	1
2	KHALFON Eden	green/blue	ON/Taifu		XX			0	0	4
3	SUZUKI Yoshiki	blue	USAJUDO/Budokan Dojo		10	XX	10	2	20	2
4	CONNOLLY Liam	green	BC/Westsyde		10		XX	1	10	3

## Matches/Matches

Match	White/Blanc			Blue/Bleu	Res/Rés	Tim/Tmp	Code
C-5	BOUCHARD Jean-David	1	2	KHALFON Eden	10 - 0	0:30	WIP
C-6	SUZUKI Yoshiki	3	4	CONNOLLY Liam	10 - 0	0:51	IPO
C-27	BOUCHARD Jean-David	1	3	SUZUKI Yoshiki	10 - 0	0:55	IPO
C-28	KHALFON Eden	2	4	CONNOLLY Liam	0 - 10	0:23	IPO
C-37	BOUCHARD Jean-David	1	4	CONNOLLY Liam	10 - 0	0:12	IPO
C-38	KHALFON Eden	2	3	SUZUKI Yoshiki	0 - 10	0:38	IPO

## Results/Résultats

Pos	Name/Nom
1	BOUCHARD Jean-David, QC/Fermont
2	SUZUKI Yoshiki, USAJUDO/Budokan Dojo
3	CONNOLLY Liam, BC/Westsyde