

SenF -48kg

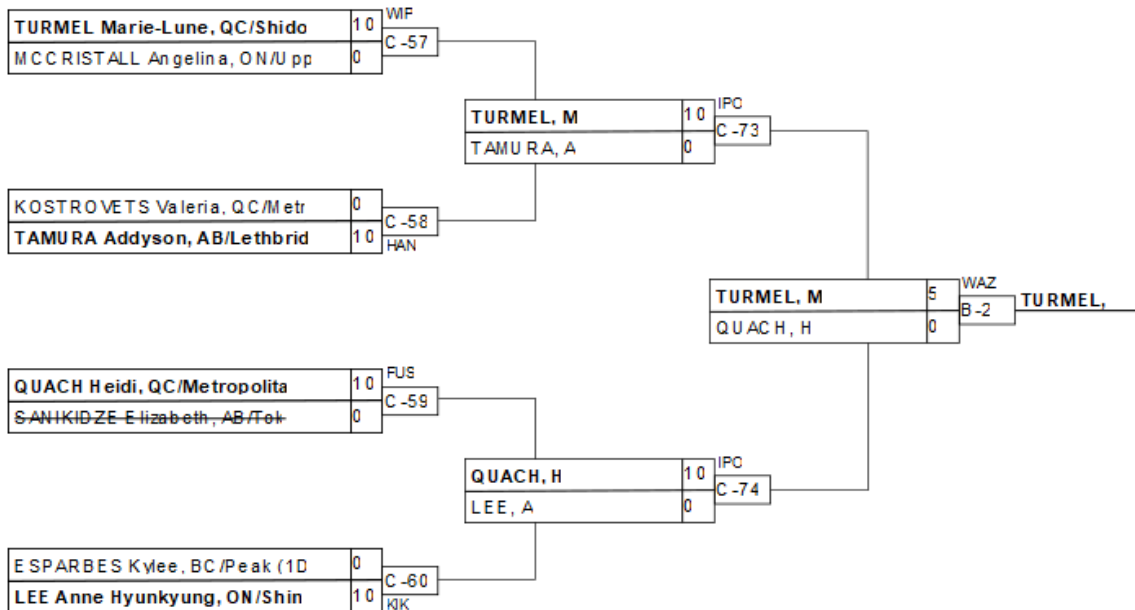

Résultats/Results

Pos	Nom/Name
1	TURMEL Marie-Lune, QC/Sh
2	QUACH Heidi, QC/M etropol
3	TAMURA Addyson, AB/Lethb
3	KOSTROVETS Valeria, QC/M

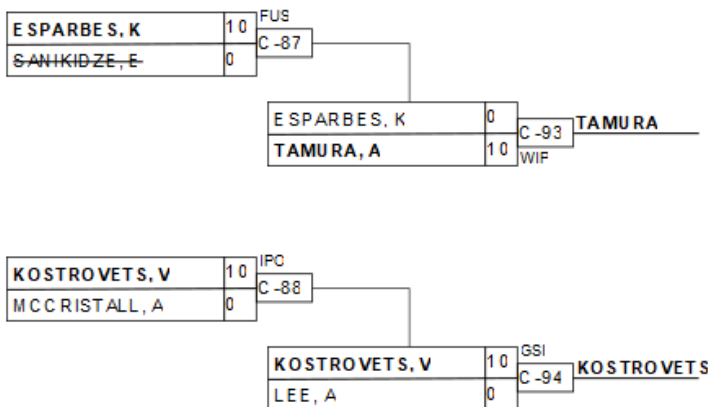

SenF -52kg

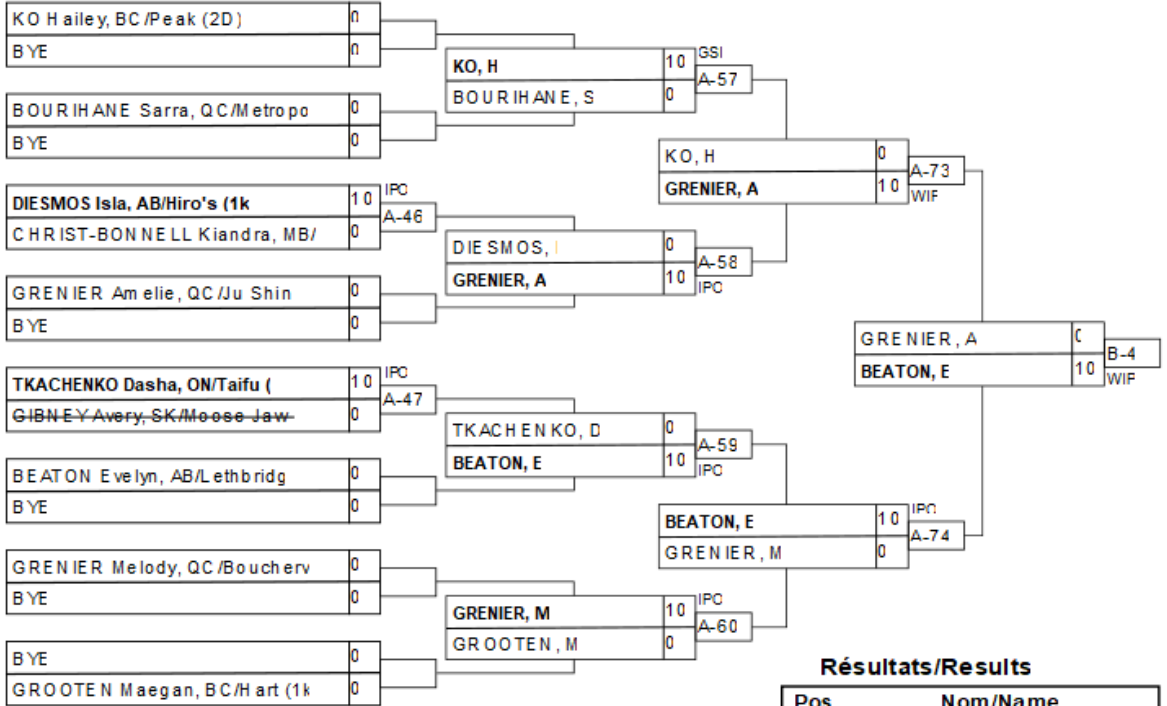

Résultats/Results

Pos	Nom/Name
1	BEATON Evelyn, AB/Lethbr
2	GRENIER Amelie, QC/Ju Sh
3	KO Hailey, BC/Peak (2D)
3	GRENIER Melody, QC/Bouch

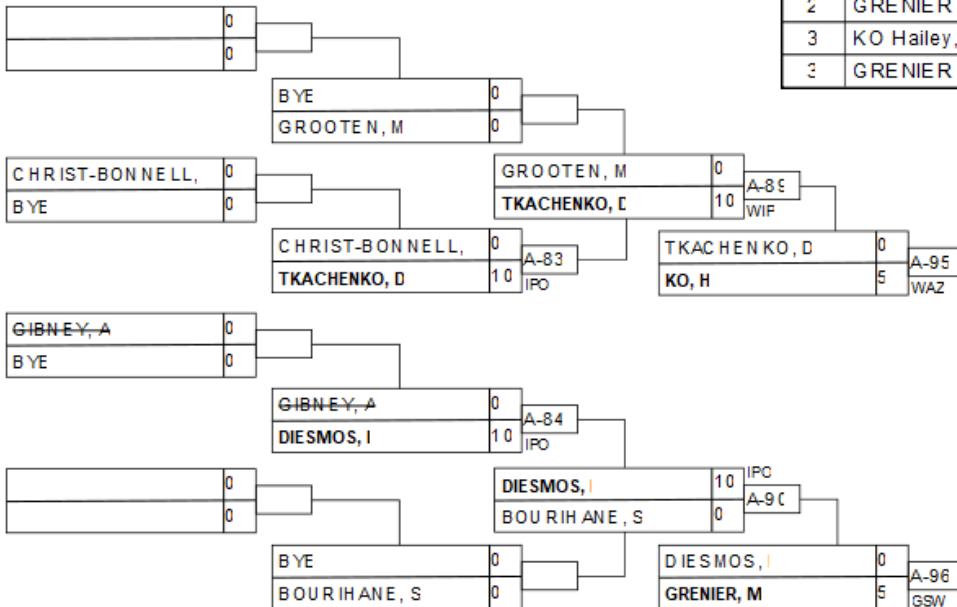

SenF -57kg

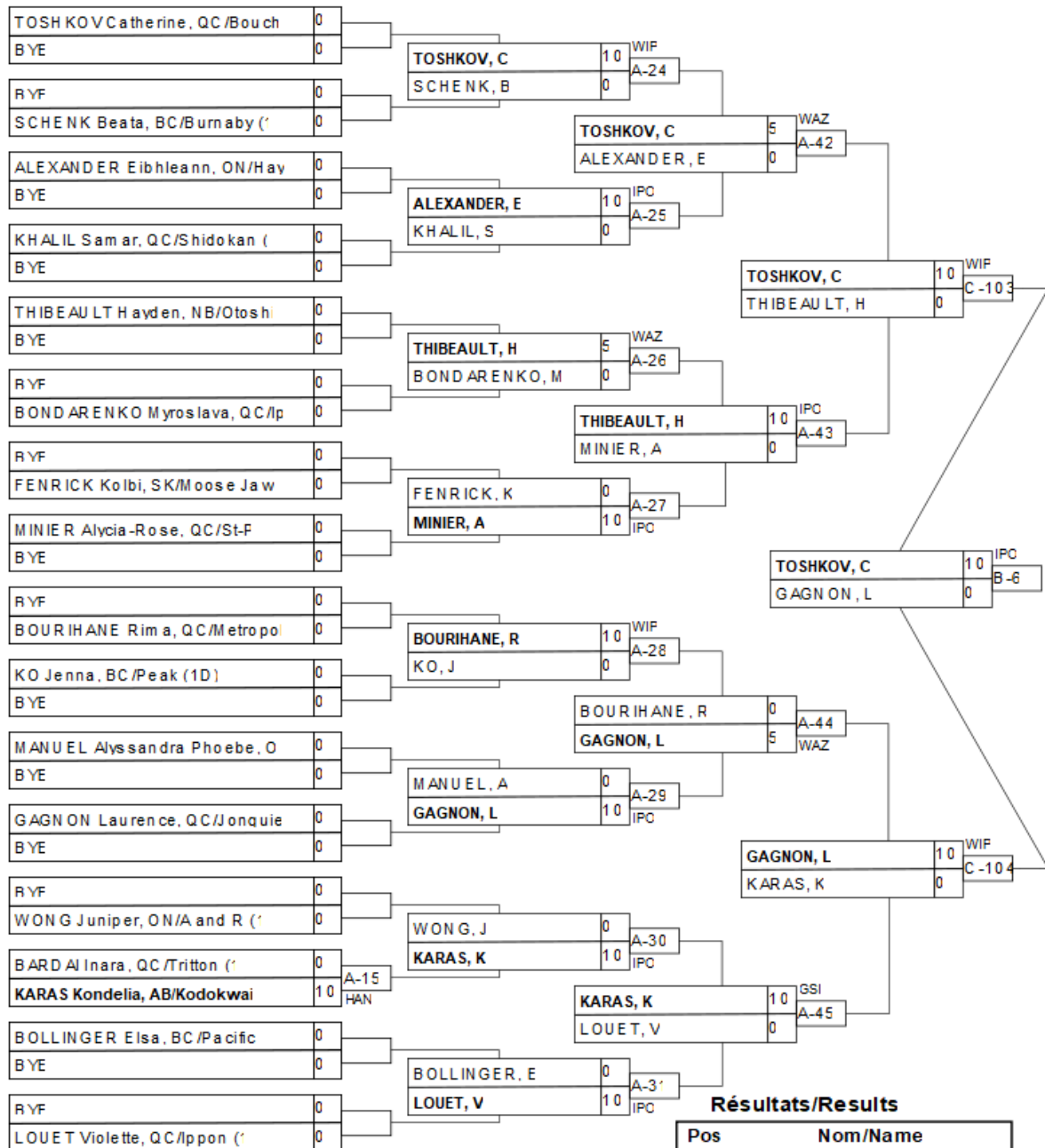

Résultats/Results

Pos	Nom/Name
1	TOSHKOV Catherine, QC/Bouch
2	GAGNON Laurence, QC/Jonquie
3	BONDARENKO Myroslava, QC/lp
4	KARAS Kondelia, AB/Kodokwai

SenF -63kg

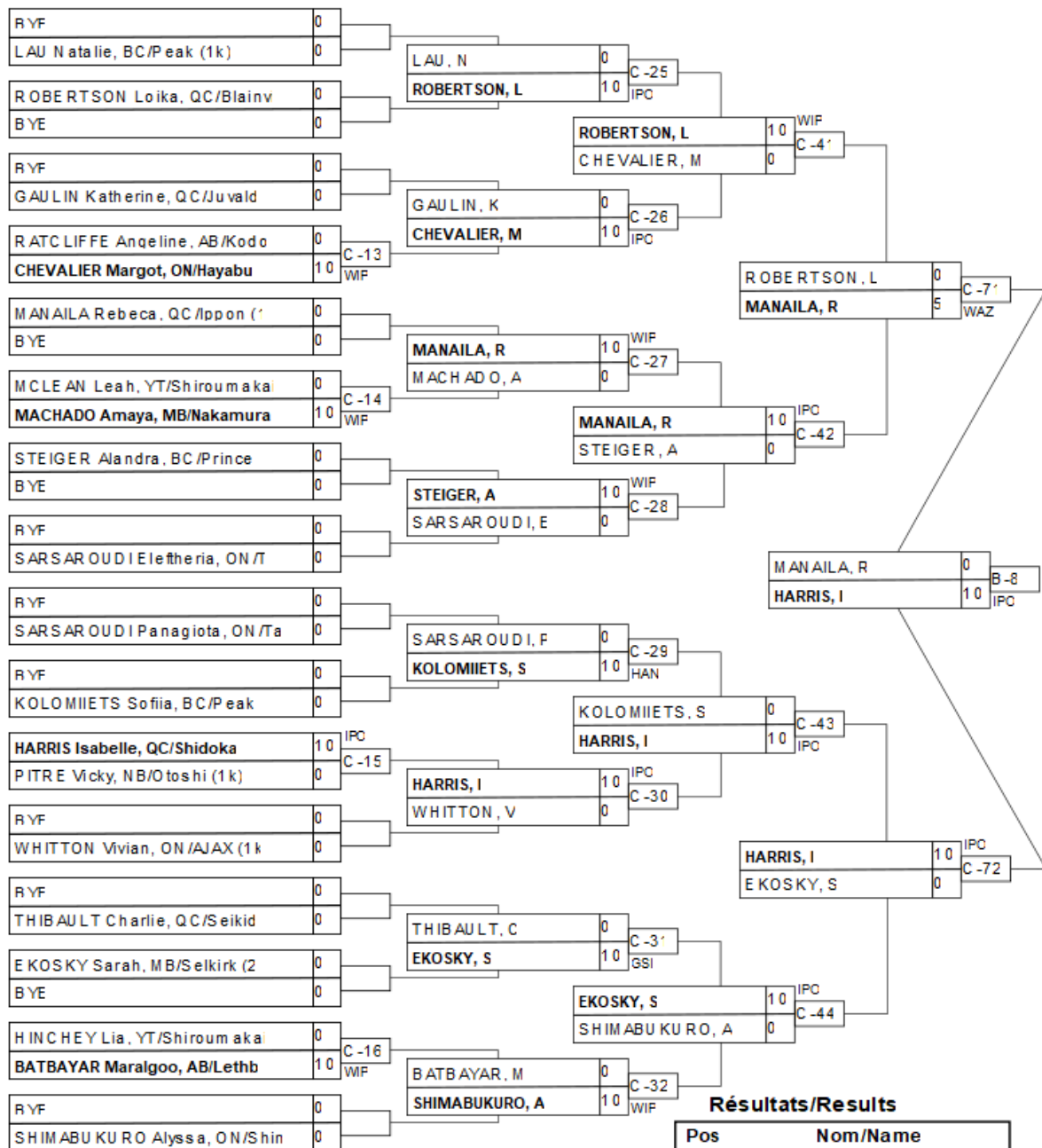

Résultats/Results

Pos	Nom/Name
1	HARRIS Isabelle, QC/Shid
2	MANAILA Rebeca, QC/Ippon
3	ROBERTSON Loika, QC/Blai
3	EKOSKY Sarah, MB/Selkirk

SenF -70kg

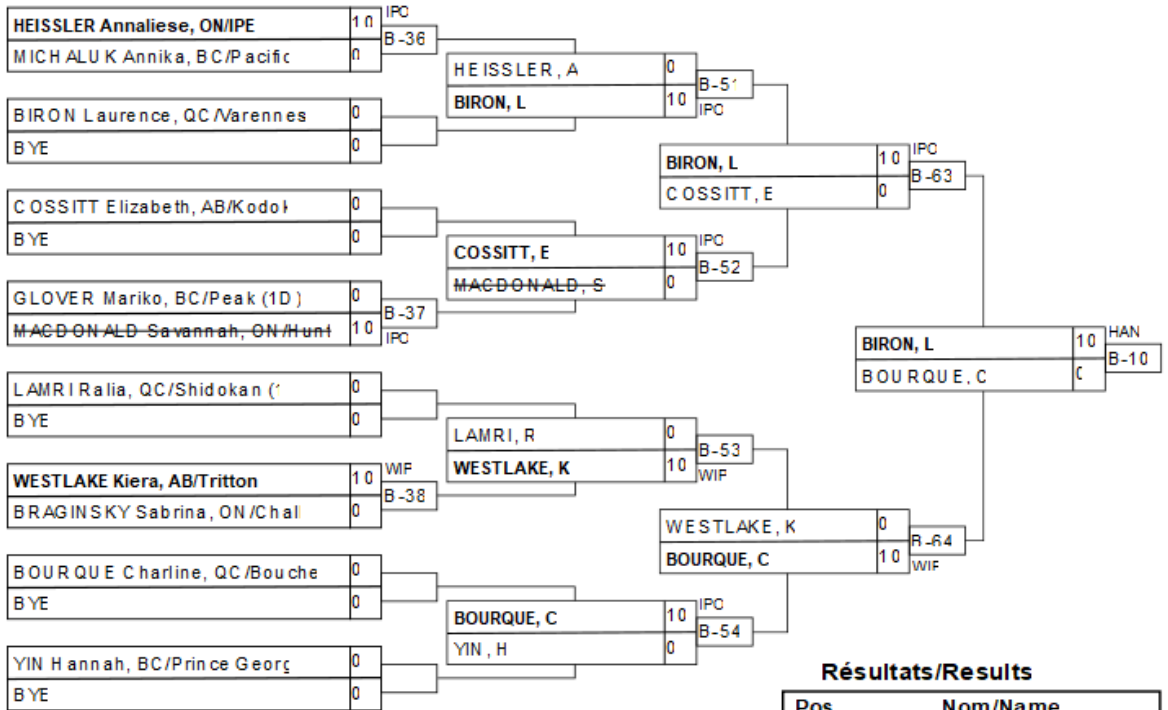

Résultats/Results

Pos	Nom/Name
1	BIRON Laurence, QC/Varen
2	BOURQUE Charline, QC/Bou
3	COSSITT Elizabeth, AB/Ko
3	WESTLAKE Kiera, AB/Tritt

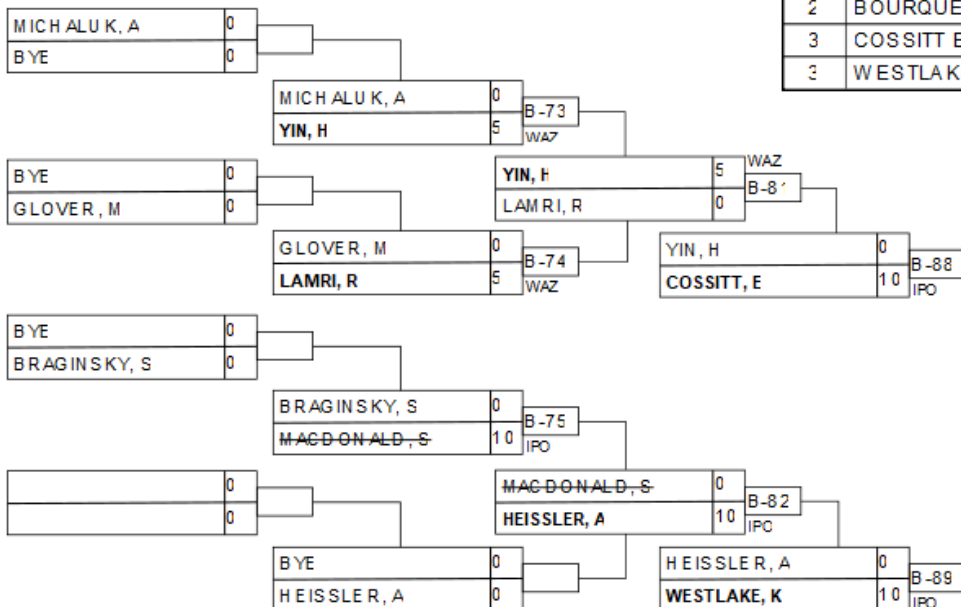

SenF -78kg

Compétiteurs/Competitors

#	Nom/Name	Grade	Club	1	2	1	2	1	2	G/W	Pts	Pos
1	GODBOUT Coralie	1D	QC/Kiseki	XX	10	XX	10	XX		2	20	1
2	LEE Bassa Mihyun	1k	ON/Shin Bu Kan		XX		XX		XX	0	0	2

Matches/Matches

Match	Blanc/White			Bleu/Blue	Rés/Res	Tmp/Tim	Code
B-65	GODBOUT Coralie	1	2	LEE Bassa Mihyun	10 - 0	0:34	IPO
B-76	LEE Bassa Mihyun	2	1	GODBOUT Coralie	0 - 10	0:57	IPO
B-83	GODBOUT Coralie	1	2	LEE Bassa Mihyun			

Résultats/Results

Pos	Nom/Name
1	GODBOUT Coralie, QC/Kiseki

SenF +78kg

Compétiteurs/Competitors

#	Nom/Name	Grade	Club	1	2	3	4	5	G/W	Pts	Pos
1	MCALPINE Amanda	1D	ON/Full Circle	XX					0	0	5
2	LAVIGNE Frederique	1D	QC/Metropolitain	10	XX	10	10	10	4	40	1
3	KOFMAN Alisa	1k	ON/Challenge	10		XX			1	10	4
4	DESBIENS Sara	1D	QC/Ju Shin Kan	10		10	XX		2	20	3
5	KARAS Marianna	1D	AB/Kodokwai	10		10	10	XX	3	30	2

Matches/Matches

Match	Blanc/White			Bleu/Blue	Rés/Res	Tmp/Tim	Code
D-53	DESBIENS Sara	4	5	KARAS Marianna	0 - 10	1:43	IPO
D-54	MCALPINE Amanda	1	2	LAVIGNE Frederique	0 - 10	2:25	IPO
D-63	KOFMAN Alisa	3	4	DESBIENS Sara	0 - 10	0:35	WIP
D-64	MCALPINE Amanda	1	5	KARAS Marianna	0 - 10	2:13	WIP
D-71	LAVIGNE Frederique	2	3	KOFMAN Alisa	10 - 0	1:03	IPO
D-72	MCALPINE Amanda	1	4	DESBIENS Sara	0 - 10	2:39	WIP
D-81	KOFMAN Alisa	3	5	KARAS Marianna	0 - 10	1:04	IPO
D-82	LAVIGNE Frederique	2	4	DESBIENS Sara	10 - 0	1:35	HAN
D-89	MCALPINE Amanda	1	3	KOFMAN Alisa	0 - 10	0:00	FUS
B-12	LAVIGNE Frederique	2	5	KARAS Marianna	10 - 0	2:33	IPO

Résultats/Results

Pos	Nom/Name
1	LAVIGNE Frederique, QC/Metropolitain
2	KARAS Marianna, AB/Kodokwai
3	DESBIENS Sara, QC/Ju Shin Kan
4	KOFMAN Alisa, ON/Challenge

SenM -100kg

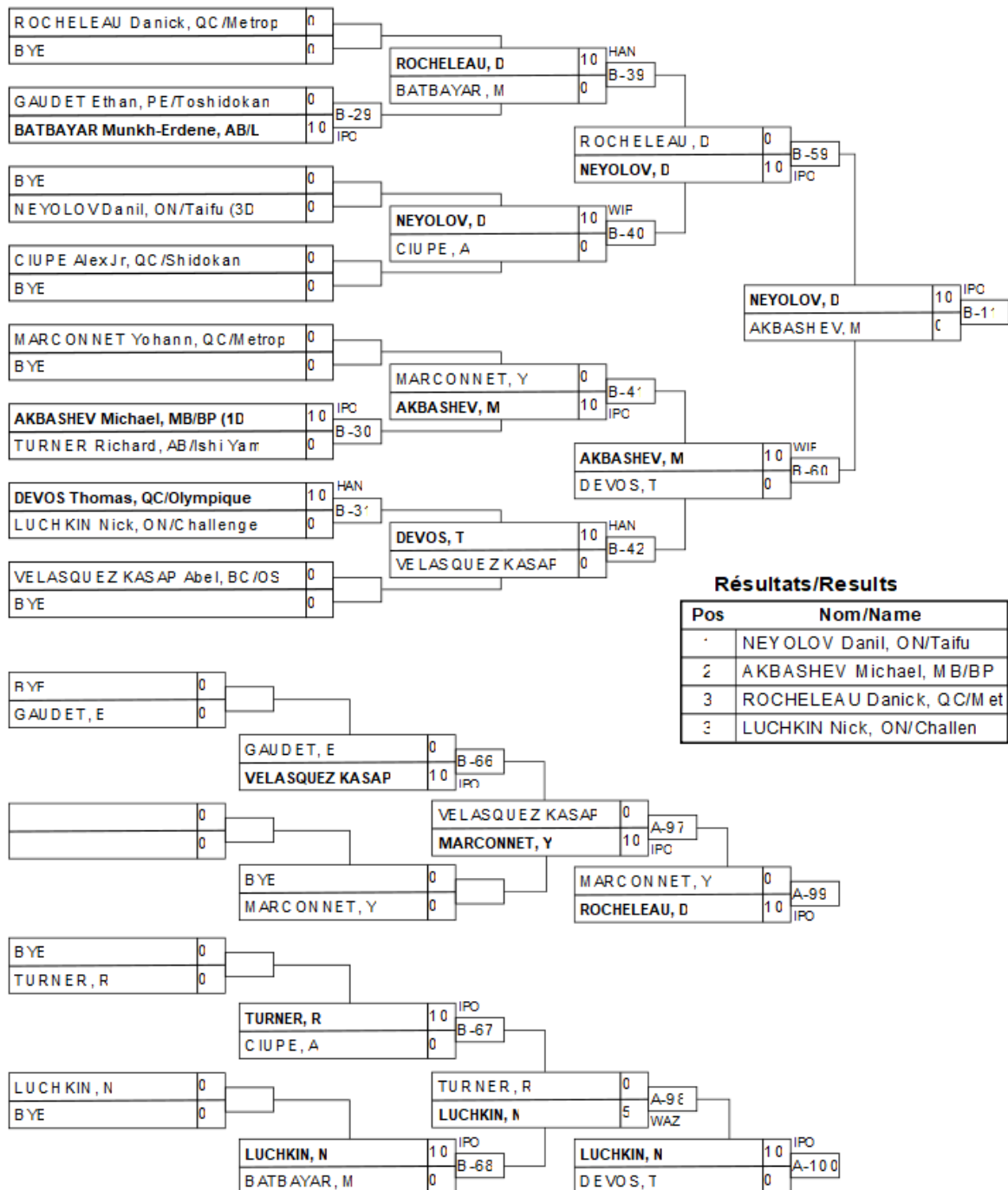

Résultats/Results

Pos	Nom/Name
1	NEYOLOV Danil, ON/Taifu
2	AKBASHEV Michael, M B/BP
3	ROCHELEAU Danick, QC/M et
3	LUCHKIN Nick, ON/Challen

SenM -60kg

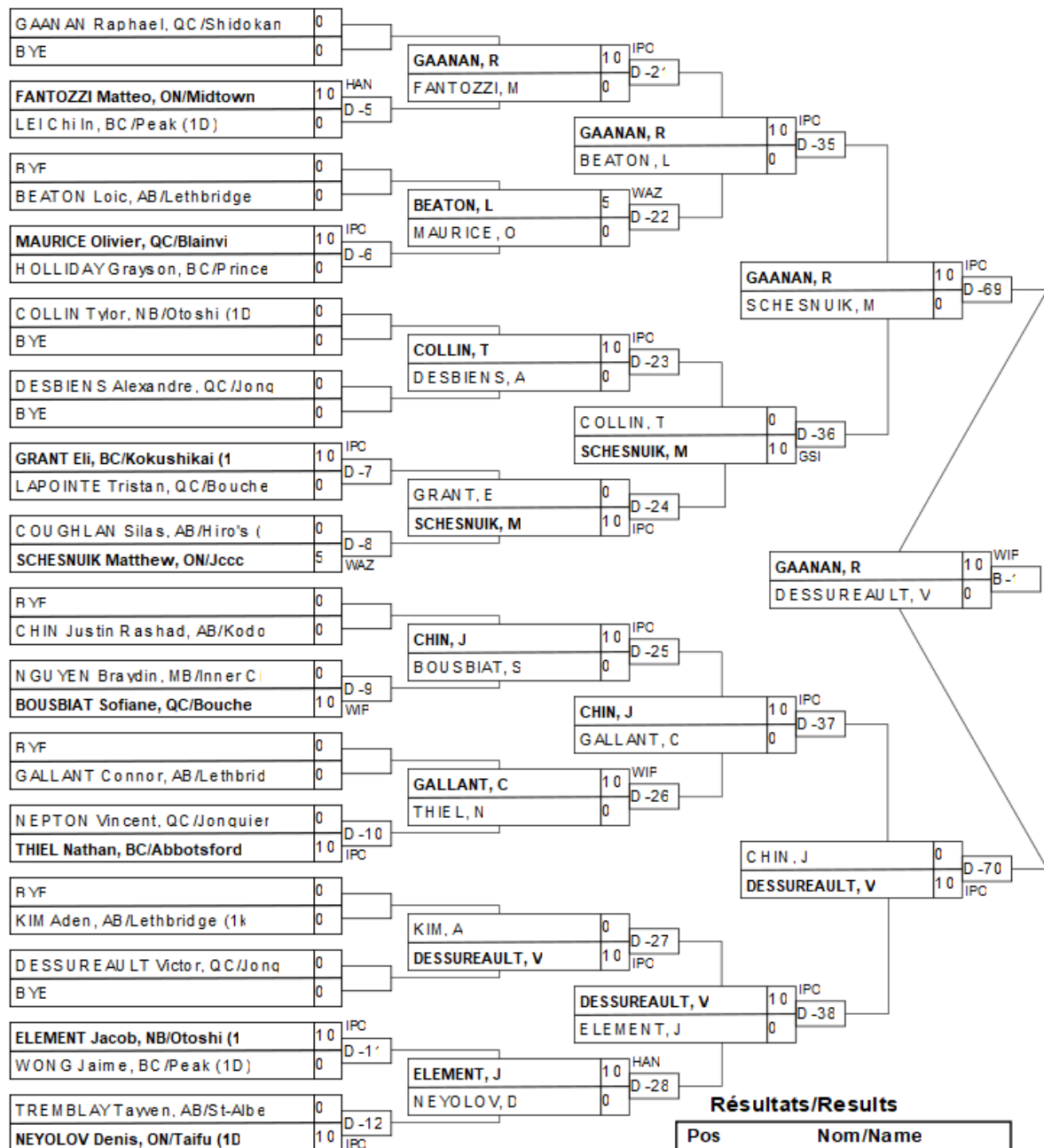

Résultats/Results

Pos	Nom/Name
1	GAANAN Raphael, QC/Shido
2	DESSUREAULT Victor, QC/J
3	DESBIENS Alexandre, QC/J
4	CHIN Justin Rashad, AB/K

SenM -66kg

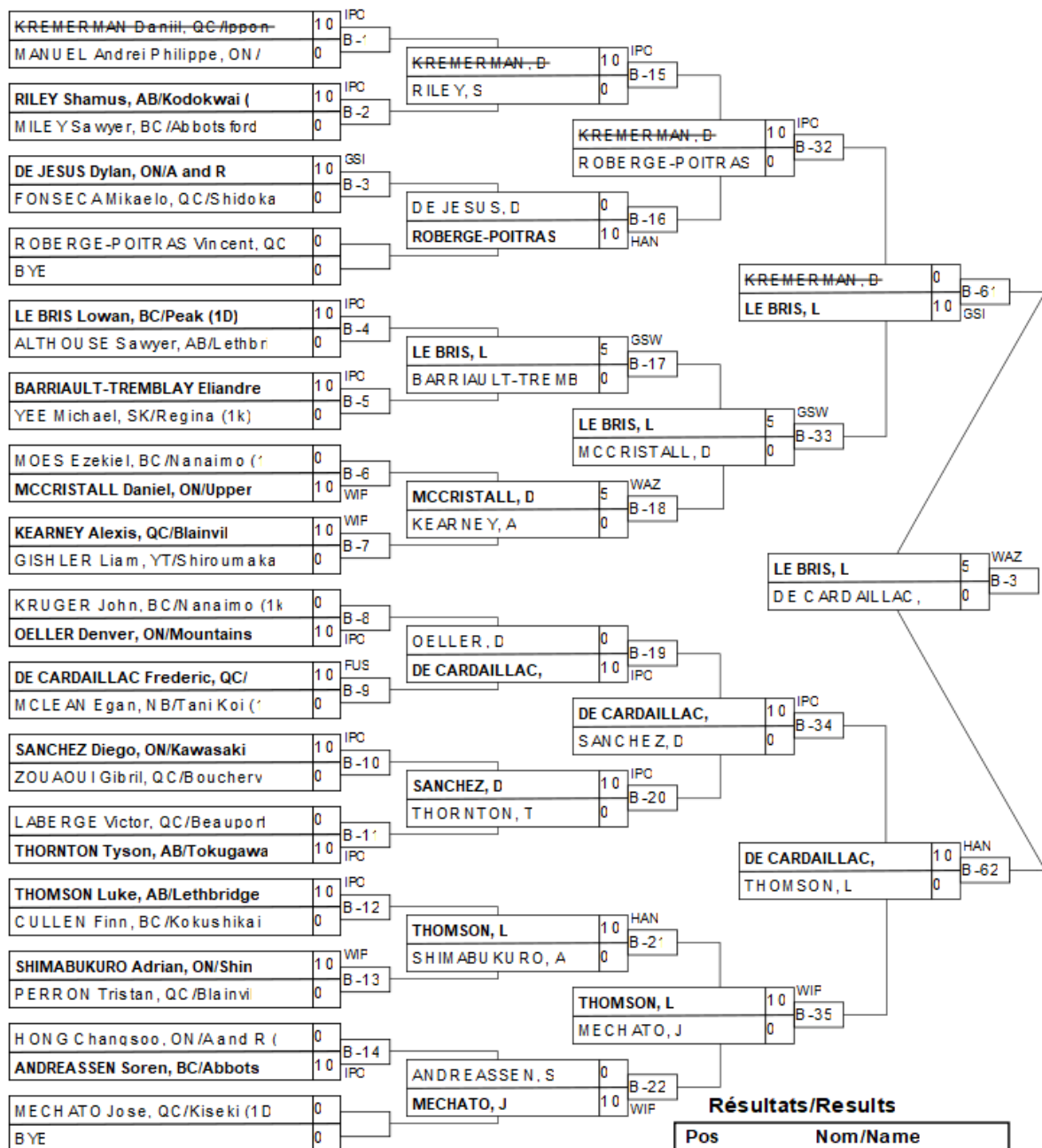

Résultats/Results

Pos	Nom/Name
1	LE BRIS Lowan, BC/Peak (
2	DE CARDAILLAC Frederic,
3	SANCHEZ Diego, ON/Kawasa
4	THOMSON Luke, AB/Lethbri

SenM -73kg

MERCIER ROSS Felix, QC/Metr	0				
BYE	0				
BERNS Mason, BC/Kokushikai	10	IPC	MERCIER ROSS, F	10	WIF
LEVIN E Aaron, ON/A and R (3	0	A-1	BERN S, M	0	A-16
HACHEMI Yanis, QC/St-Paul I	10	GSI	MERCIER ROSS, F	0	
E KOSKY Damien, MB/Selkirk (0	A-2	HACHEMI, Y	10	A-38
MELNYKOV Nikita, BC/Peak (1	10	IPC	HACHEMI, Y	10	HAN
ABAD OU Hicham, ON/Ottawa (0	A-3	MELN YKOV, N	0	A-17
VASQUEZ John, ON/Kawasaki (0	A-4	HACHEMI, Y	10	IPC
ANTOSH Ryan, BC/Peak (10)	10	IPC	TSATSALASHVILI,	0	A-69
VILLA Nicolas, MB/Nakamura	0	A-5	ANTOSH, R	0	
DUBE Louis-Maxime, QC/Jonqu	10	WIF	DUBE, L	10	A-18
TSATSALASHVILI Lasha, ON/Ta	10	WIF	DUBE, L	0	WIF
BOURGOIN Maxime, NB/Otoshi	0	A-6	TSATSALASHVILI,	10	A-39
LAZENBY Aidan, AB/Lethbridg	0	A-7	TSATSALASHVILI,	5	WAZ
GANET Matis, QC/Kiseki (10)	10	IPC	GANET, M	0	A-19
KING Adrian, ON/Kawasaki (0	A-8	HACHEMI, Y	10	HMD/DHM
SCHROEDER Finn, BC/Peak (20)	10	IPC	LEMIRE, J	0	B-5
DESGAGNE-DOYON Felix, QC/Pe	0		SCHROEDER, F	10	IPC
BYE	0		DESGAGNE-DOYON,	0	A-20
NEYOLOV Artem, ON/TaiFu (10)	0	A-9	SCHROEDER, F	5	GSW
ZALESKI Ivan, AB/St-Alber	0		GAGNON, O	0	A-40
GAGNON Olivier, QC/Jonquier	10	IPC	NEYOLOV, A	0	A-21
WALSH Iain, BC/Kokushikai (0	A-10	GAGNON, O	10	HAN
LEMIRE Justin, QC/Metropo	0	A-11	SCHROEDER, F	0	
KOLOMIETS Anton, BC/Pea	0		LEMIRE, J	0	A-70
ZVYAGIN Ivan, ON/Shin Bu Ka	0	A-12	LAUNDER, C	0	A-22
LAUNDER Charlie, MB/Keisats	10	HAN	LEMIRE, J	0	
HARRIS Zachary, BC/Abbotsfo	0	A-13	CHALA, H	0	A-41
CHALA Hakim, QC/Kiseki (10)	10	IPC	CHALA, H	10	IPC
STANG R iley, SK/Sas kato n (0	A-14	VARGA, S	0	A-23
VARGA Stefano, ON/Hayabusak	10	IPC			

Résultats/Results

Pos	Nom/Name
1	HACHEMI Yanis, QC/St-Pau
2	
3	TSATSALASHVILI Lasha, ON
4	MERCIER ROSS Felix, QC/M

SenM -81kg

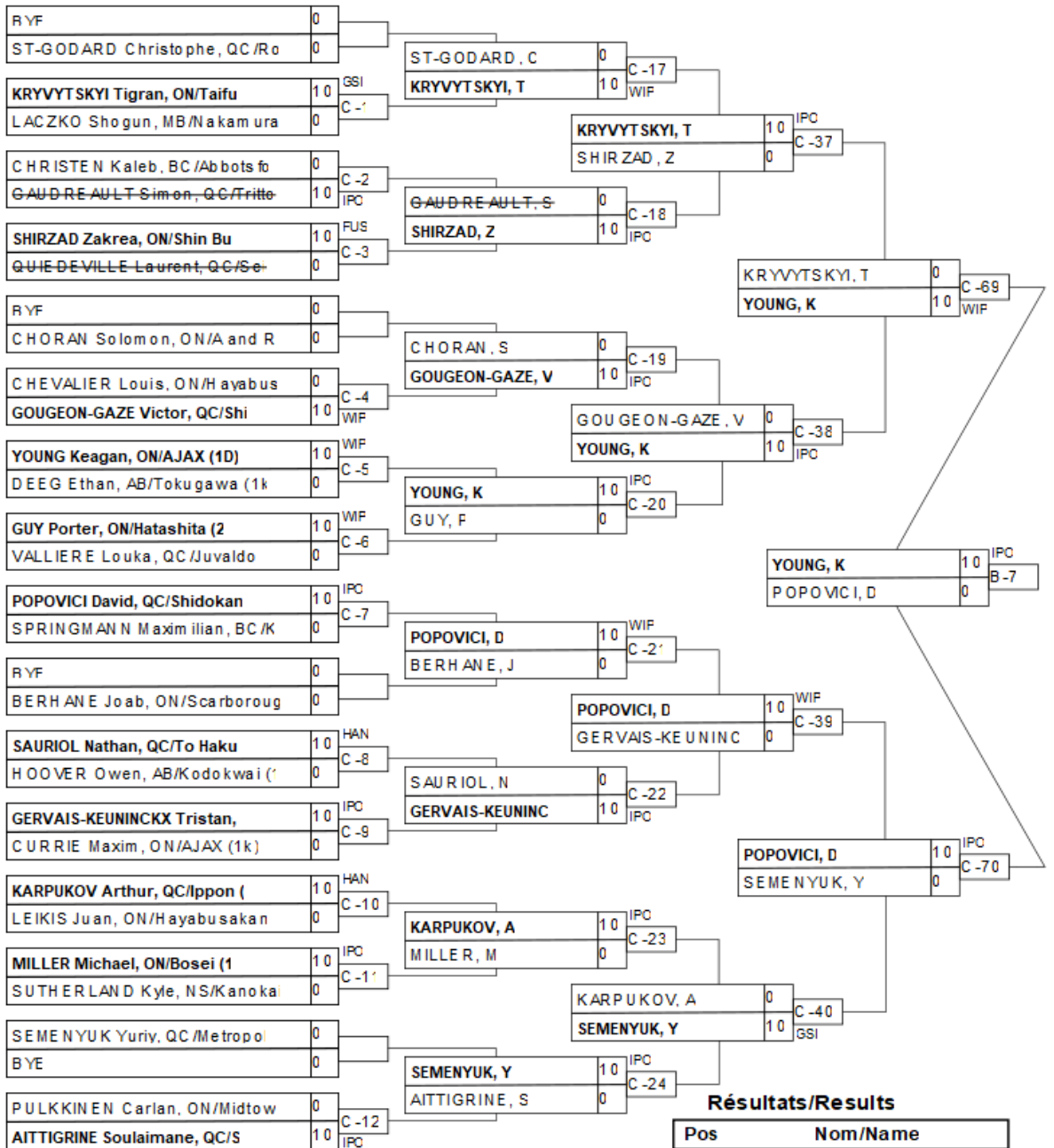

Résultats/Results

Pos	Nom/Name
1	YOUNG Keagan, ON/AJAX (1)
2	POPOVICI David, QC/Shido
3	CHORAN Solomon, ON/A and R
4	GOUGEON-GAZE Victor, QC/Shi

SenM -90kg

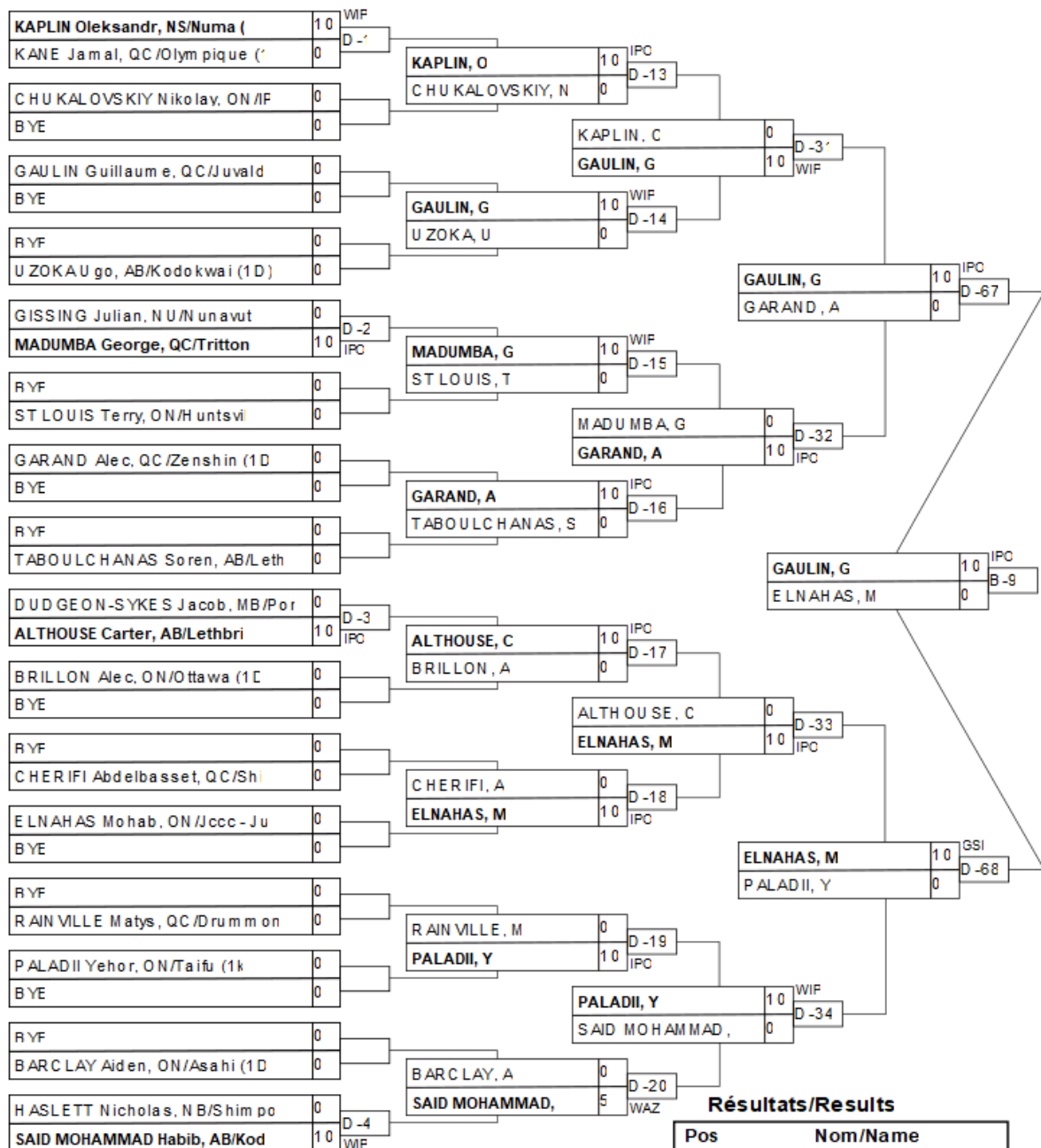

Résultats/Results

Pos	Nom/Name
1	GAULIN Guillaume, QC/Juv
2	ELNAHAS Mohab, ON/Jccc -
3	GARAND Alec, QC/Zenshin
3	PALADII Yehor, ON/Taifu

SenM +100kg

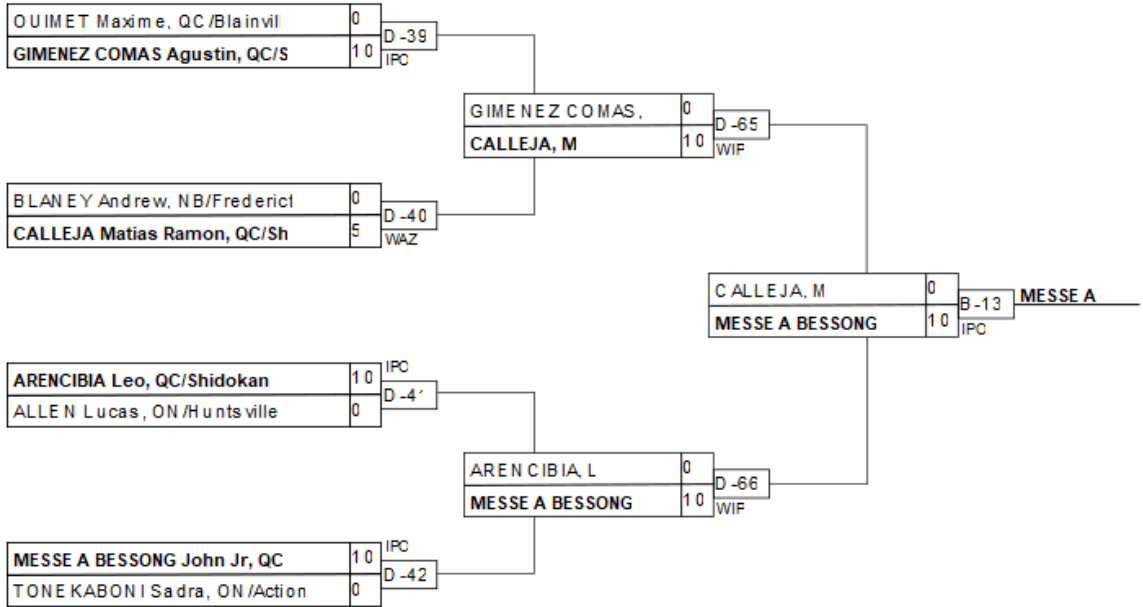

Résultats/Results

Pos	Nom/Name
1	MESSE A BESSONG John Jr,
2	CALLEJA Matias Ramon, QC
3	TONEKABONI Sadra, ON/A ct
3	ARENCIBIA Leo, QC/Shidok

