

SMBB -100 kg

Competitors

#	Name	Grade	Club	1	2	1	2	1	2	Wins	Pts	Pos
1	NEYOLOV Dani	2D	Taifu	XX	10	XX		XX	10	2	20	1
2	AKBASHEV Michael	1D	BP Judo club		XX	10	XX		XX	1	10	2

Matches

Match	White	Blue	Result	Time	Code
B-102	NEYOLOV Danil	AKBASHEV Michae	1 - 2	10 - 0	4:57 GS
B-109	AKBASHEV Michael	NEYOLOV Dani	2 - 1	10 - 0	1:39 IPO
B-116	NEYOLOV Danil	AKBASHEV Michae	1 - 2	10 - 0	3:44 IPO

Results

Pos	Name
1	NEYOLOV Danil, Taifu
2	AKBASHEV Michael, BP Judo club

SMBB -60 kg

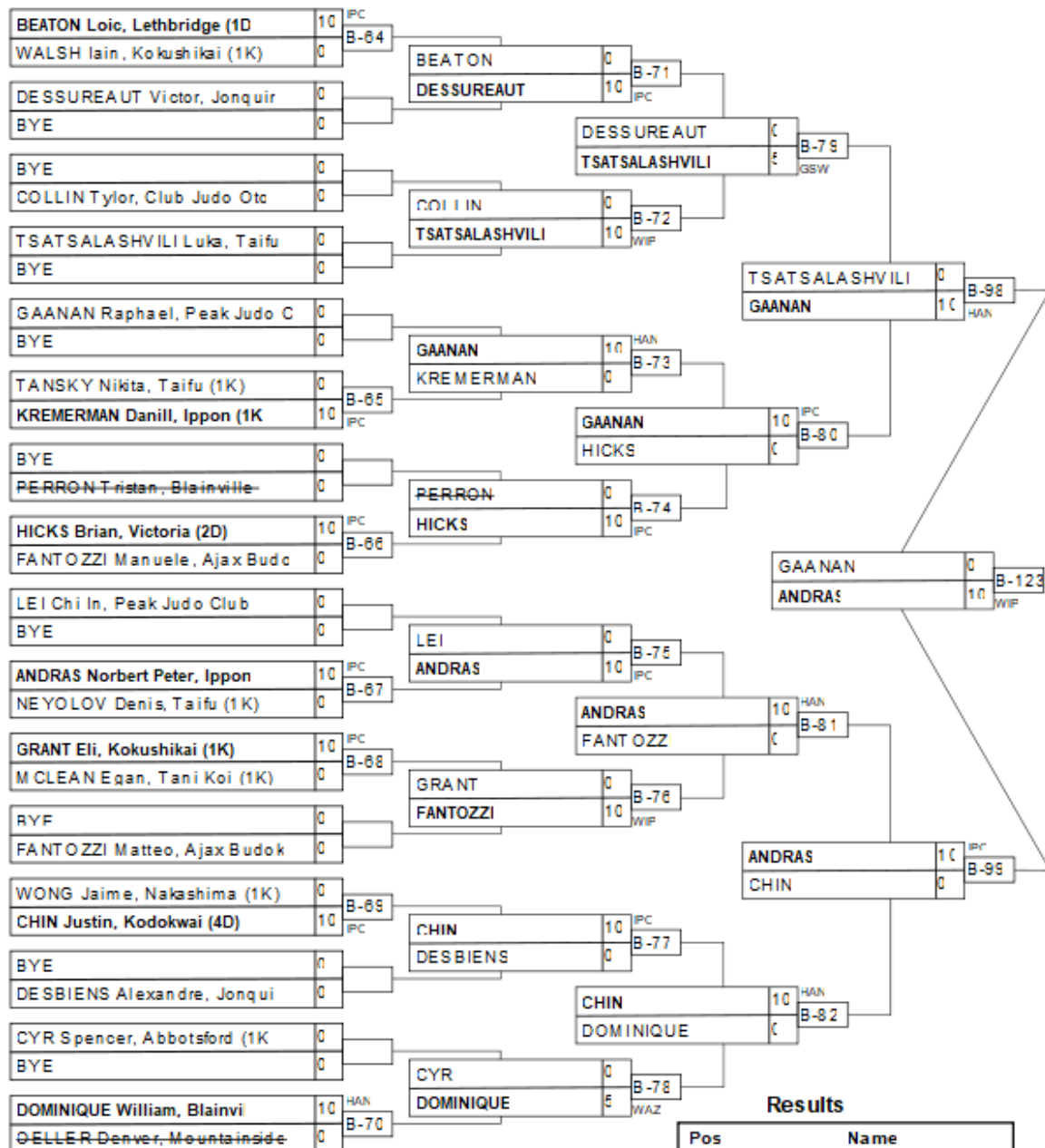

Results

Pos	Name
1	ANDRAS Norbert Peter, Ip
2	GAANAN Raphael, Peak Jud
3	KREMERMAN Daniil, Ippon
3	DESSUREAUT Victor, Jonqu

SMBB -66 kg

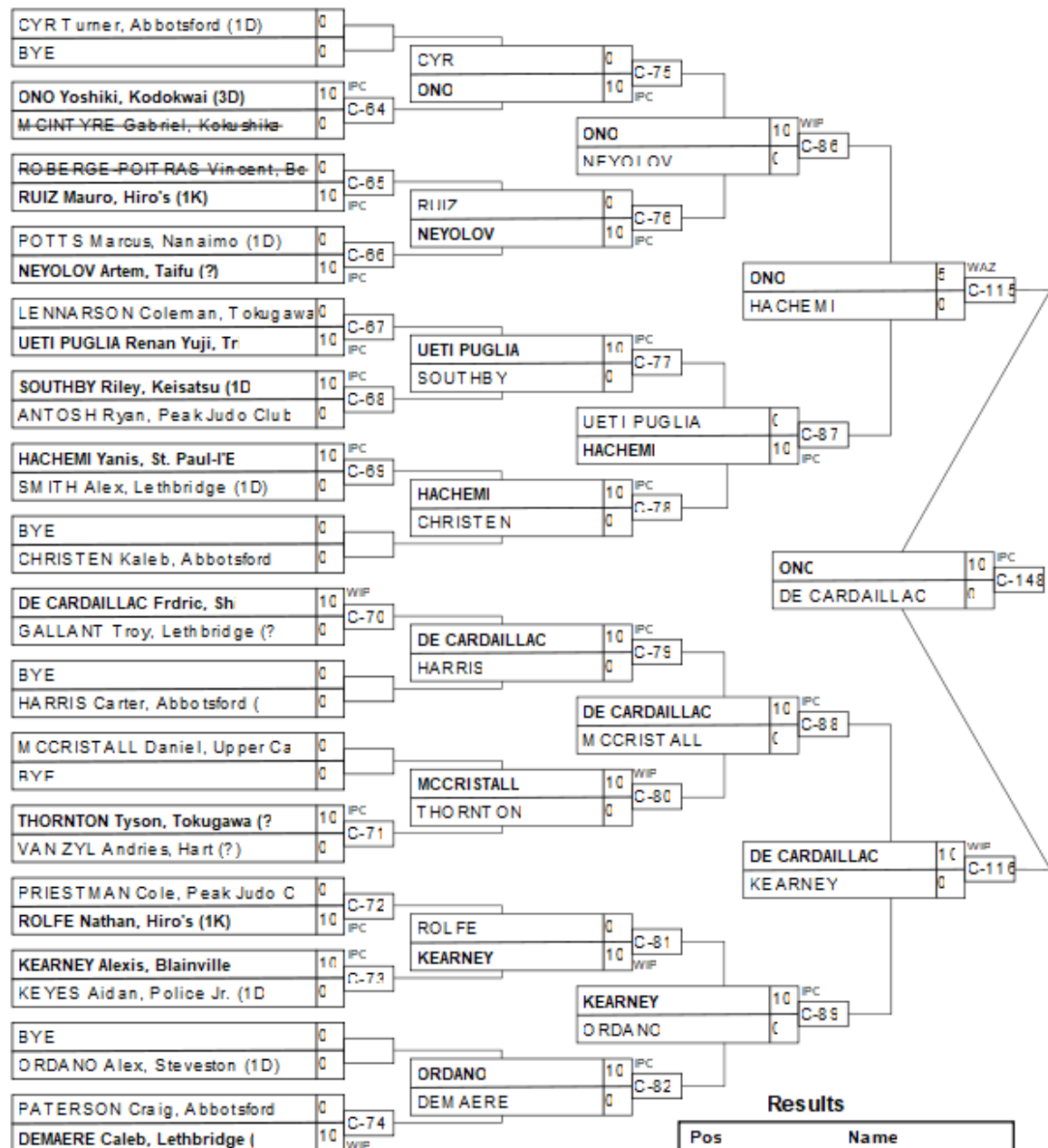

Results

Pos	Name
1	ONO Yoshiki, Kodokwai (3)
2	DE CARDAILLAC Frdric,
3	HACHEMI Yanis, St. Paul-
3	UETI PUGLIA Renan Yuji,

SMBB -73 kg

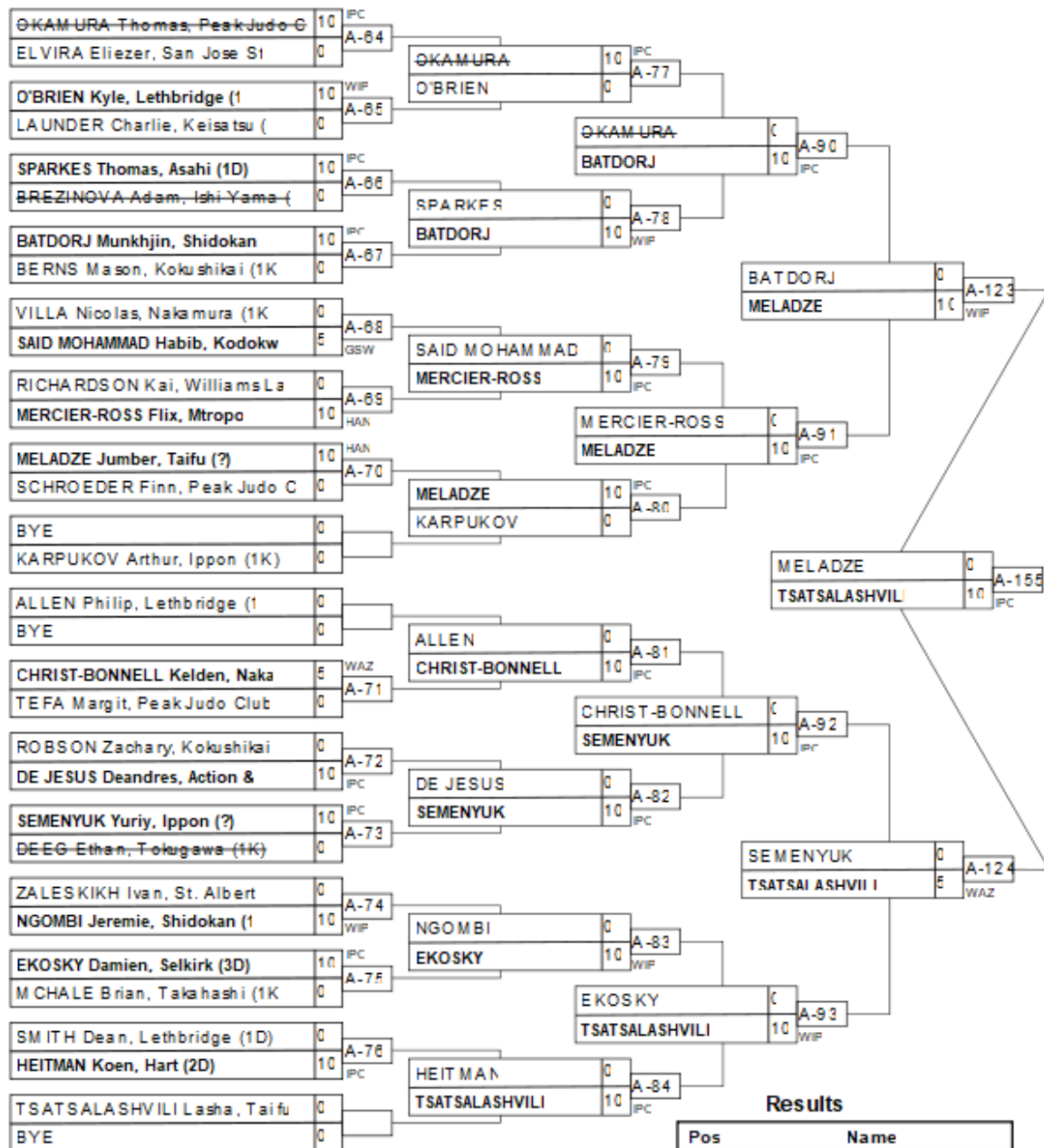

Results

Pos	Name
1	TSATSALASHVILI Lasha, Taifu
2	MELADZE Jumber, Taifu (?)
3	BATDORJ Munkhjin, Shidokan
3	MERCIER-ROSS Flix, Mtr

SMBB -81 kg

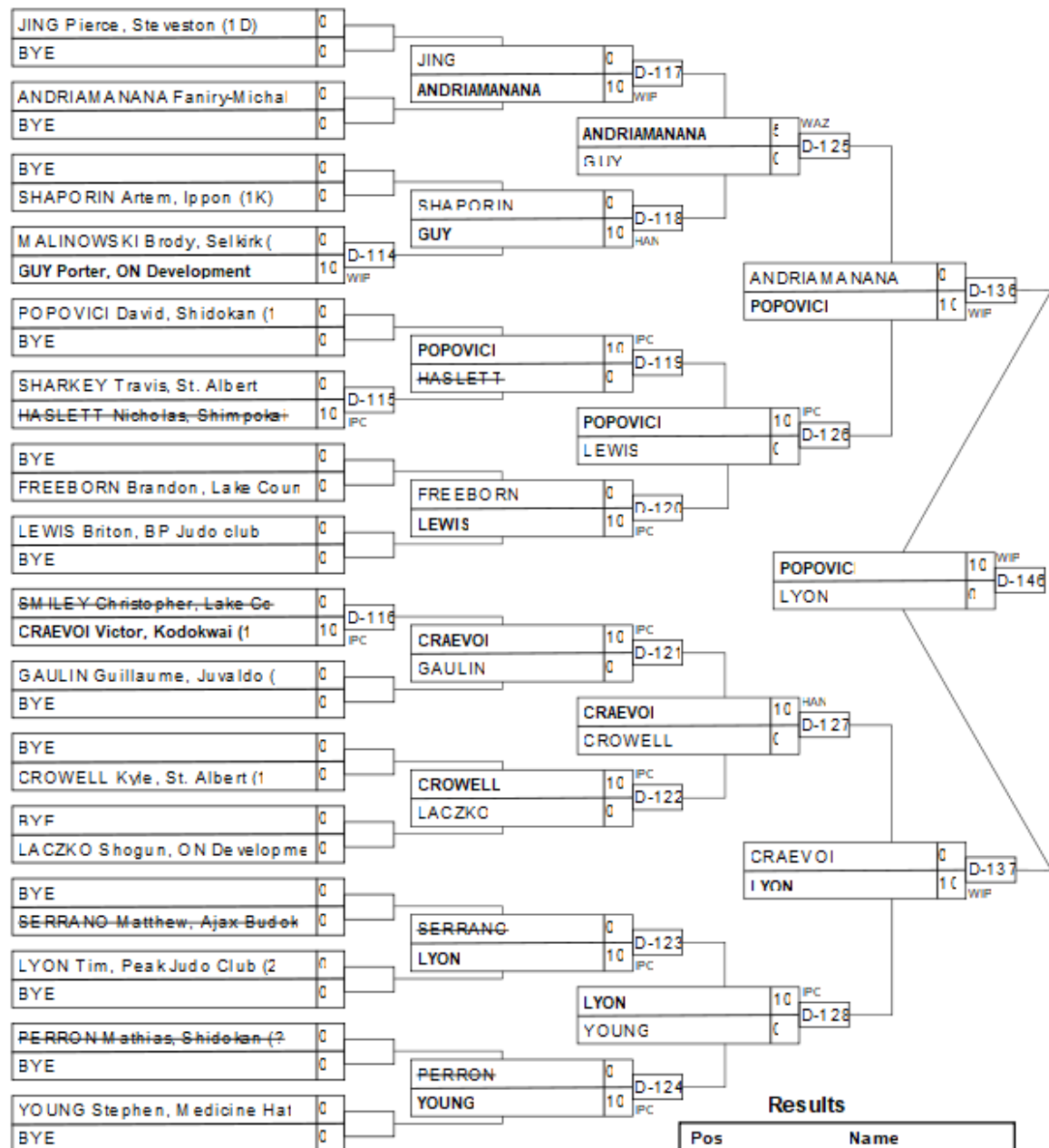

SMBB -90 kg

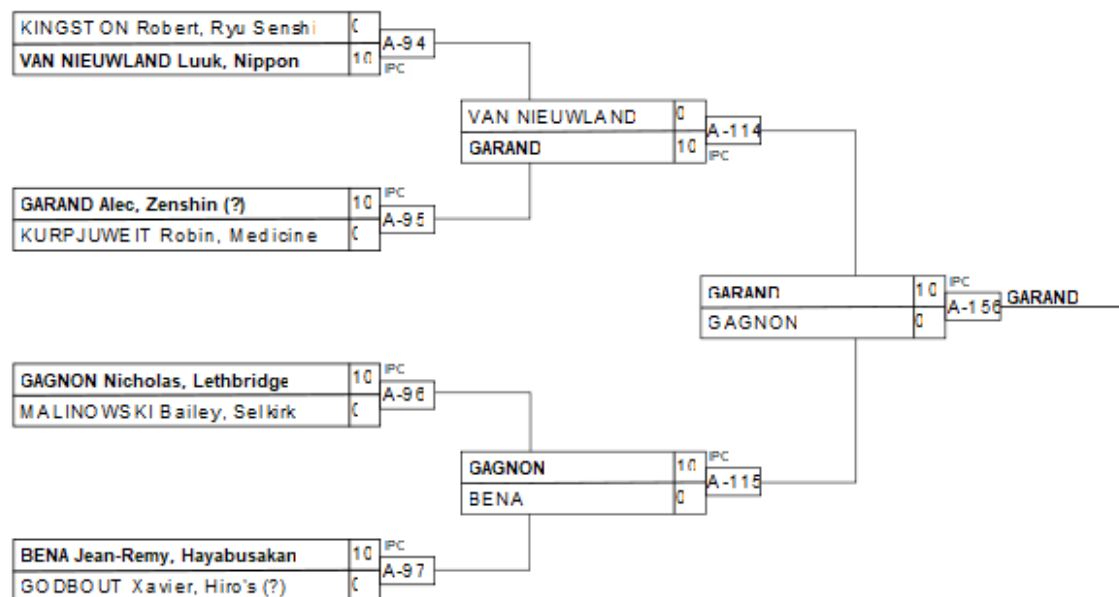

Results

Pos	Name
1	GARAND Alec, Zenshin (?)
2	GAGNON Nicholas, Lethbri
3	VAN NIEUWLAND Luuk, Nipp
3	BENA Jean-Remy, Hayabusa

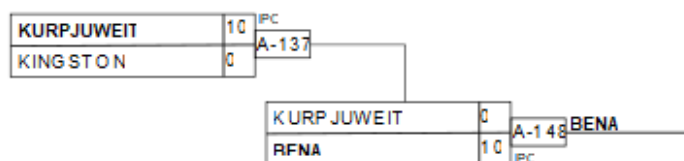
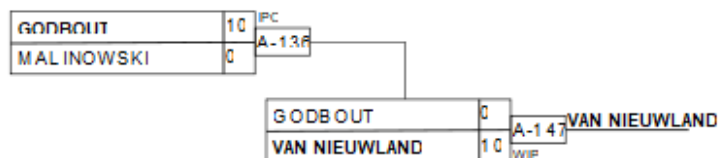

SMBB +100 kg

Competitors

#	Name	Grade	Club	1	2	3	4	5	Wins	Pts	Pos
1	BLANEY Andrew	2D	Fredericton	XX	10			5	2	15	3
2	MURPHY Michae	1K	Fudoshin		XX				0	0	5
3	PIVOVAR Mark	2D	Kodokwa	10	10	XX		10	3	30	2
4	CROSS Nick	1K	Tritton	10	10	10	XX	10	4	40	1
5	GUERALT Michae	1K	Evolution		10			XX	1	10	4

Matches

Match	White			Blue	Result	Time	Code
A-98	CROSS Nick	4	5	GUERALT Michae	10 - 0	2:15	IPO
A-99	BLANEY Andrew	1	2	MURPHY Michae	10 - 0	1:23	IPO
A-108	PIVOVAR Mark	3	4	CROSS Nick	0 - 10	3:26	IPO
A-109	BLANEY Andrew	1	5	GUERALT Michae	5 - 0	4:00	WAZ
A-116	MURPHY Michae	2	3	PIVOVAR Mark	0 - 10	0:13	IPO
A-117	BLANEY Andrew	1	4	CROSS Nick	0 - 10	1:21	IPO
A-125	PIVOVAR Mark	3	5	GUERALT Michae	10 - 0	0:50	IPO
A-126	MURPHY Michae	2	4	CROSS Nick	0 - 10	0:20	IPO
A-138	BLANEY Andrew	1	3	PIVOVAR Mark	0 - 10	3:00	WIF
A-139	MURPHY Michae	2	5	GUERALT Michael	0 - 10	0:10	IPO

Results

Pos	Name
1	CROSS Nick, Tritton
2	PIVOVAR Mark, Kodokwa
3	BLANEY Andrew, Fredericton
4	GUERALT Michael, Evolution

SMYB -100 kg

Competitors

#	Name	Grade	Club	1	2	3	4	Wins	Pts	Pos
1	HINTON Jesse	5K	Hayabusa	XX			10	1	10	3
2	COLE Jacob	4K	St. Albert	5	XX	10	10	3	25	1
3	ILIFFE Jonathan	2K	Lake Country	10		XX	10	2	20	2
4	BERNAKEVITCH Andrew	5K	Tokugawa				XX	0	0	4

Matches

Match	White			Blue	Result	Time	Code
C-121	HINTON Jesse	1	2	COLE Jacob	0 - 5	4:00	WAZ
C-122	ILIFFE Jonathan	3	4	BERNAKEVITCH Andrew	10 - 0	0:32	IPO
C-132	HINTON Jesse	1	3	ILIFFE Jonathan	0 - 10	1:04	WIF
C-133	COLE Jacob	2	4	BERNAKEVITCH Andrew	10 - 0	1:16	WIF
C-140	HINTON Jesse	1	4	BERNAKEVITCH Andrew	10 - 0	0:30	IPO
C-141	COLE Jacob	2	3	ILIFFE Jonathan	10 - 0	1:00	IPO

Results

Pos	Name
1	COLE Jacob, St. Albert
2	ILIFFE Jonathan, Lake Country
3	HINTON Jesse, Hayabusa

SMYB -66 kg

Competitors

#	Name	Grade	Club	1	2	3	4	Wins	Pts	Pos
1	LONTAYAO Aj	2K	Campbell River	XX		10		1	10	3
2	CULLEN Finn	2K	Kokushika	10	XX		10	2	20	1
3	KOBES Terrance	5K	Ryu Senshi		10	XX		1	10	4
4	BALDONADO Billy-Joe	5K	Ishi Yama	10		10	XX	2	20	2

Matches

Match	White			Blue	Result	Time	Code
D-82	LONTAYAO Aj	1	2	CULLEN Finn	0 - 10	0:26	IPO
D-83	KOBES Terrance	3	4	BALDONADO Billy-Joe	0 - 10	0:44	WIF
D-94	LONTAYAO Aj	1	3	KOBES Terrance	10 - 0	1:33	WIF
D-95	CULLEN Finn	2	4	BALDONADO Billy-Joe	10 - 0	3:18	IPO
D-103	LONTAYAO Aj	1	4	BALDONADO Billy-Joe	0 - 10	1:51	WIF
D-104	CULLEN Finn	2	3	KOBES Terrance	0 - 10	1:10	IPO

Results

Pos	Name
1	CULLEN Finn, Kokushika
2	BALDONADO Billy-Joe, Ishi Yama
3	LONTAYAO Aj, Campbell River
4	KOBES Terrance, Ryu Senshi

SMYB -73 kg

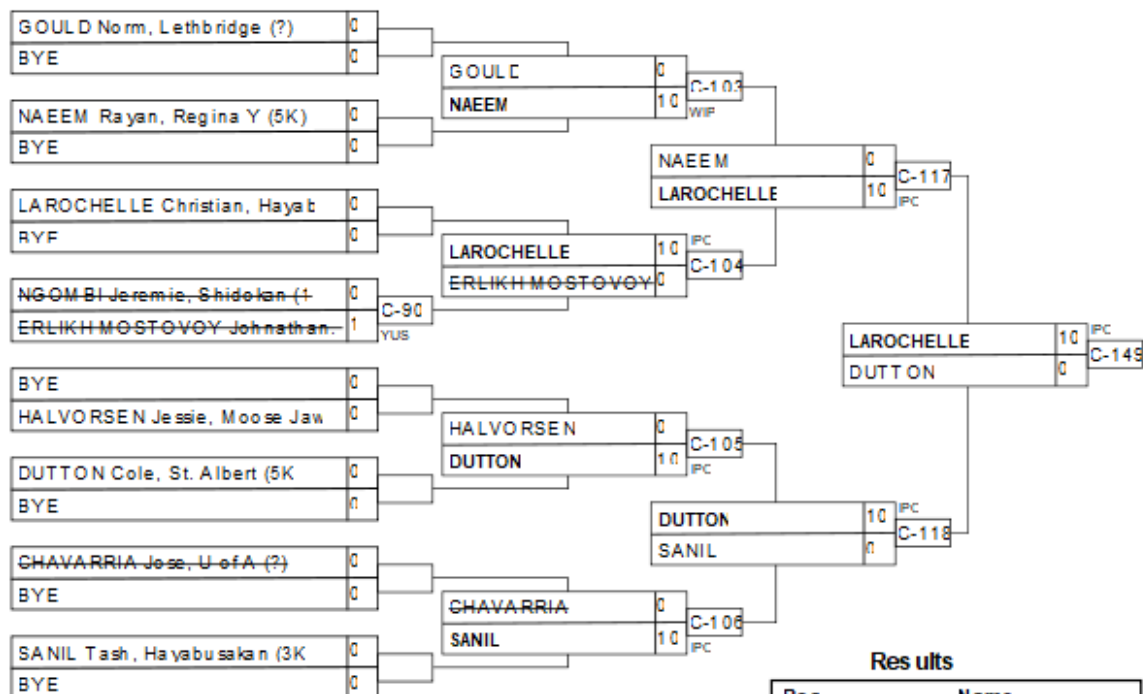

SMYB -81 kg

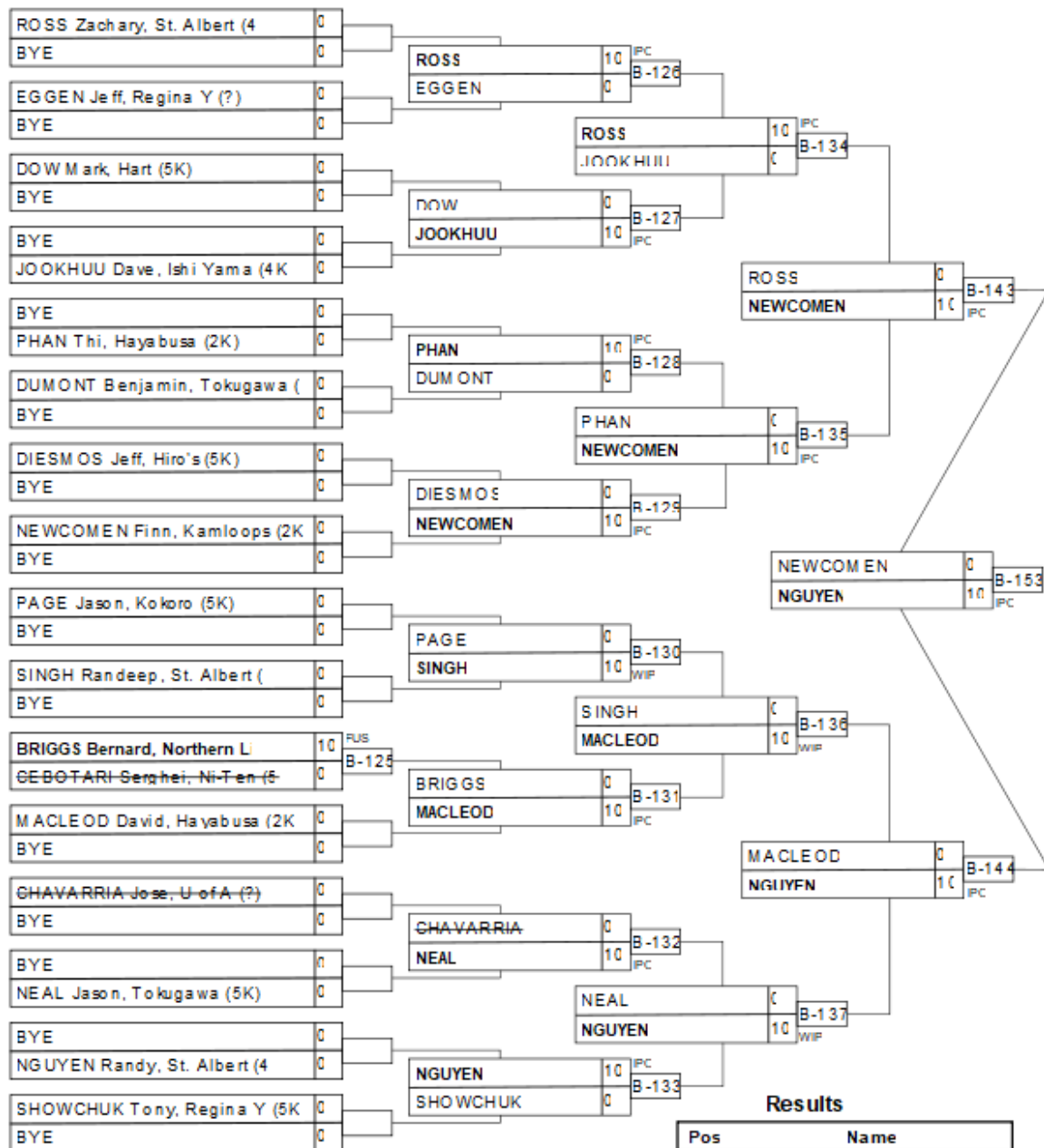

SMYB -90 kg

Competitors A

#	Name	Grade	Club	1	2	3	4	Wins	Pts	Pos
1	JARECKI Mike	4K	Kodokwa	XX		10		1	10	3
2	DUFFY Owen	3K	Medicine Hat	10	XX	10	10	3	30	1
3	ALI Haider	5K	Regina Y			XX		0	0	4
4	PAXMAN Eric	5K	U of A	10		10	XX	2	20	2

Pool A

Match	White	Blue	Result	Time	Code
D-79	JARECKI Mike	1 2 DUFFY Owen	0 - 10	2:14	IPO
D-80	ALI Haider	3 4 PAXMAN Eric	0 - 10	0:45	WIF
D-91	JARECKI Mike	1 3 ALI Haider	10 - 0	0:08	IPO
D-92	DUFFY Owen	2 4 PAXMAN Eric	10 - 0	1:07	IPO
D-100	JARECKI Mike	1 4 PAXMAN Eric	0 - 10	2:41	HAN
D-101	DUFFY Owen	2 3 ALI Haider	10 - 0	0:55	WIF

Competitors B

#	Name	Grade	Club	5	6	7	Wins	Pts	Pos
5	HOOVER Stuart	2K	Kodokwa	XX	10	10	2	20	1
6	LADOUCEUR Lucas	5K	Ni-Ten		XX	10	1	10	2
7	FORSBERG Mattias	?	Lethbridge			XX	0	0	3

Pool B

Match	White	Blue	Result	Time	Code
D-81	HOOVER Stuart	5 6 LADOUCEUR Lucas	10 - 0	0:20	IPO
D-93	HOOVER Stuart	5 7 FORSBERG Mattias	10 - 0	1:55	IPO
D-102	LADOUCEUR Lucas	6 7 FORSBERG Mattias	10 - 0	0:25	IPO

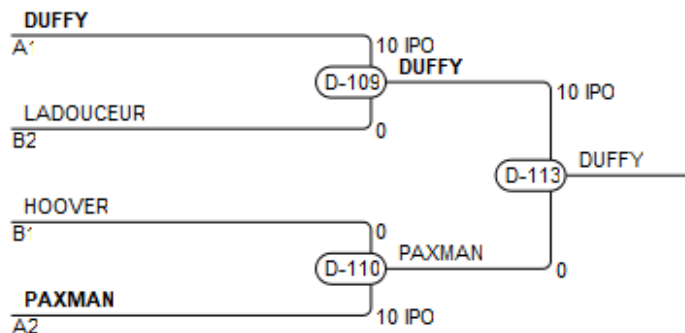

Results

Pos	Name
1	DUFFY Owen, Medicine Hat
2	PAXMAN Eric, U of A
3	LADOUCEUR Lucas, Ni-Ten
3	HOOVER Stuart, Kodokwa

SMYB +100 kg

Competitors

#	Name	Grade	Club	1	2	3	4	Wins	Pts	Pos
1	HRYNIW Bobby	4K	Tolide	XX				0	0	4
2	TURNER Richard	3K	Ishi Yama	10	XX	10	10	3	30	1
3	VELASQUEZ KASAP Abel	?	Police Jr.	10		XX		1	10	3
4	ADAMS Jordan	2K	Hoku Sei Kan	10		10	XX	2	20	2

Matches

Match	White		Blue	Result	Time	Code	
D-131A	HRYNIW Bobby	1	2	TURNER Richard	0 - 10	2:19	IPO
D-131B	VELASQUEZ KASAP Abel	3	4	ADAMS Jordan	0 - 10	0:31	IPO
D-135A	HRYNIW Bobby	1	3	VELASQUEZ KASAP Abel	0 - 10	0:16	IPO
D-135B	TURNER Richard	2	4	ADAMS Jordan	10 - 0	1:11	IPO
D-143A	HRYNIW Bobby	1	4	ADAMS Jordan	0 - 10	0:11	IPO
D-143B	TURNER Richard	2	3	VELASQUEZ KASAP Abel	10 - 0	0:44	IPO

Results

Pos	Name
1	TURNER Richard, Ishi Yama
2	ADAMS Jordan, Hoku Sei Kan
3	VELASQUEZ KASAP Abel, Police Jr.

SW -48 kg

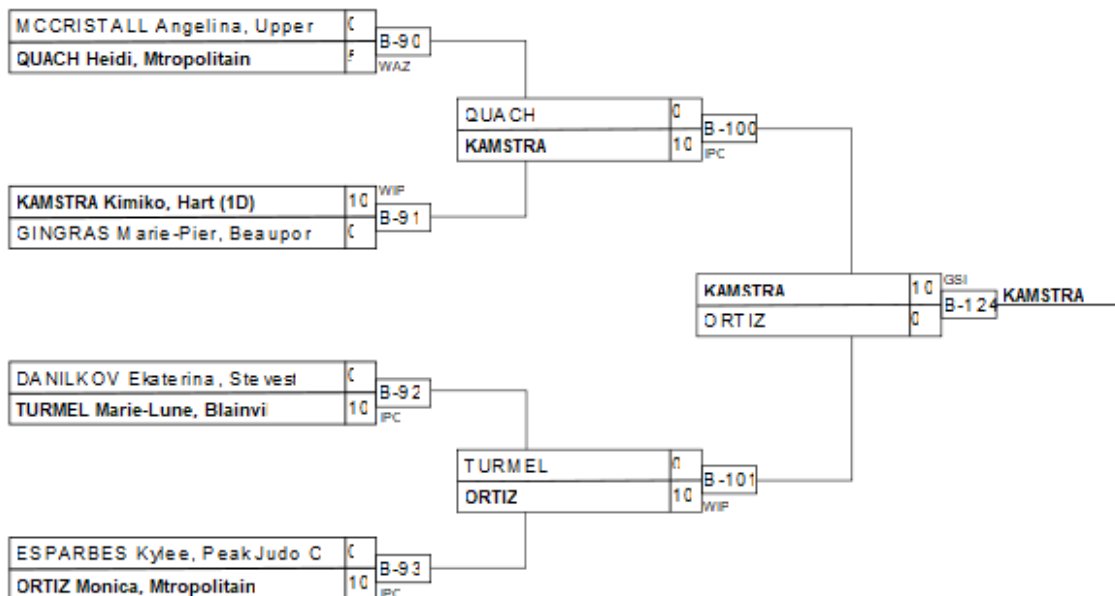

Results

Pos	Name
1	KAMSTRA Kimiko, Hart (1D)
2	ORTIZ Monica, Mtropolit
3	QUACH Heidi, Mtropolita
3	TURMEL Marie-Lune, Blair

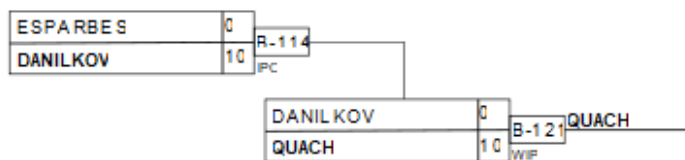

SW -52 kg

HINTON Launa, Police Jr. (1)	10	IPC	D-61	HINTON	10	WIP	D-70	HINTON	10	IPC	D-78
GIBNEY Avery, Moose Jaw (2K)	0				SIMARD-LEJEUNE	0				LOUET	
SIMARD-LEJEUNE Mathilde, Tr	0			LOLIEVA	0		D-71	HINTON	0		D-112
BYE	0				LOUET	5			WAZ	BEATON	
LOLIEVA Rakiia, Peak Judo C	10	IPC	D-62	LOUET	5	WAZ		BEATON	10	IPC	D-87
PIERRETTE KEREN-HA Akomo M	0				LOUET	5			WAZ	GAGNON	
LOUET Violette, Judo Monde	10	IPC	D-63	GAGNON	10	IPC	D-73	BEATON	10	IPC	D-87
QUERIN Mackenzie, Hoku Sei	0				FENRICK	0				GAGNON	
BEATON Evelyn, Lethbridge (0			BEATON	10	IPC	D-72	BEATON	10	IPC	D-87
BYE	0				SHEARER	0				GAGNON	
SHEARER Lola, Steveston (1K)	0			GAGNON	10	IPC	D-73	BEATON	10	IPC	D-87
BYE	0				FENRICK	0				GAGNON	
GAGNON Laurence, Jonquire	10	WIP	D-64	FENRICK	0			BEATON	10	IPC	D-87
CHRIST-BONNELL Kiandra, Nak	0				FENRICK	0				GAGNON	
TKACHENKO Dasha, Tai fu (?)	0		D-65	FENRICK	0			BEATON	10	IPC	D-87
FENRICK Kolbi, Moose Jaw (2	10	IPC			FENRICK	0				GAGNON	

Results

Pos	Name
1	BEATON Evelyn, Lethbridg
2	HINTON Launa, Police Jr.
3	LOUET Violette, Judo Mon
	LOLIEVA Rakiia, Peak Jud

GIBNEY	0		D-88	FENRICK	0		D-98	PIERRETTE KEREN	10	IPC	D-107
BYE	0				FENRICK	10			IPC	PIERRETTE KEREN	
PIERRETTE KEREN	10	IPC	D-74	PIERRETTE KEREN	10	HAN	D-89	PIERRETTE KEREN	0		D-107
QUERIN	0				PIERRETTE KEREN	10			HAN	LOUET	
	0			BYE	0			LOLIEVA	10	IPC	D-99
	0				LOLIEVA	0				LOLIEVA	
CHRIST-BONNELL	0		D-77	LOLIEVA	10	IPC	D-99	SIMARD-LEJEUNE	0		D-108
TKACHENKO	10	HAN			LOLIEVA	10			WIP	GAGNON	
	0			TKACHENKO	0		D-90	LOLIEVA	10	WIP	D-108
	0				SIMARD-LEJEUNE	10			WIP	GAGNON	

SW -57 kg

KOLIASKA Aliya, Lethbridge	10	IPC	C-91	KOLIASKA	10	IPC	C-107	KOLIASKA	10	IPC	C-119	KOLIASKA	0	C-150	ALEXANDER	10	IPC
LAPOINTE Sophie, Port Cart	0				KO	0				VEALE			0				ALEXANDER
BYE	0		C-92	SAVOIE	0		C-108	SAVOIE	0		C-120	ALEXANDER	0	C-120	BRESSON-ADAMS	0	
KO Hailey, Peak Judo Club (0				VEALE	10			IPC	BRESSON-ADAMS			0				JOHNSON
KARAS Kondelia, Kodokwai (1	0		C-93	ALEXANDER	10	IPC	C-109	ALEXANDER	0		C-110	ALEXANDER	0	C-110	BRESSON-ADAMS	10	IPC
SAVOIE Mahee, Club Judo Oto	10	IPC			ZHANG	0				BRESSON-ADAMS			0				JOHNSON
BYE	0		C-94	ALEXANDER	0		C-110	ALEXANDER	0		C-110	ALEXANDER	0	C-110	BRESSON-ADAMS	10	IPC
VEALE Brooklyn, Lethbridge	0				JOHNSON	0				BRESSON-ADAMS			0				JOHNSON
ALEXANDER ibhleann, Hayabu	0		C-93	ALEXANDER	10	IPC	C-109	ALEXANDER	0		C-120	ALEXANDER	0	C-120	BRESSON-ADAMS	10	IPC
BYE	0				ZHANG	0				BRESSON-ADAMS			0				JOHNSON
SAWADA Miyoko, St. Albert (0		C-93	ALEXANDER	0		C-109	ALEXANDER	0		C-120	ALEXANDER	0	C-120	BRESSON-ADAMS	10	IPC
ZHANG Liwen, Police Jr. (?)	10	IPC			BRESSON-ADAMS	0				BRESSON-ADAMS			0				JOHNSON
BRESSON-ADAMS Seleena, Leth	10	IPC	C-94	ALEXANDER	0		C-110	ALEXANDER	0		C-110	ALEXANDER	0	C-110	BRESSON-ADAMS	10	IPC
BARDAI Inara, Tritton (3K)	0				JOHNSON	0				BRESSON-ADAMS			0				JOHNSON
RYF	0		C-94	ALEXANDER	0		C-110	ALEXANDER	0		C-110	ALEXANDER	0	C-110	BRESSON-ADAMS	10	IPC
JOHNSON Kayla, Tokugawa (2K	0				JOHNSON	0				BRESSON-ADAMS			0				JOHNSON

Results

Pos	Name
1	ALEXANDER ibhleann, Hay
2	KOLIASKA Aliya, Lethbrid
3	KARAS Kondelia, Kodokwai
3	SAVOIE Mahee, Club Judo

LAPOINTE	0	C-128	LAPOINTE	0	C-128	LAPOINTE	0	C-128	LAPOINTE	0	C-128	LAPOINTE	0	C-128	LAPOINTE	0	C-128
BYE	0			JOHNSON			10			IPC			JOHNSON			0	
KARAS	0	C-138	KARAS	0	C-138	KARAS	0	C-138	KARAS	0	C-138	KARAS	0	C-138	KARAS	0	C-138
BYE	0			KARAS			10			HAN			KARAS			0	
KARAS	0	C-129	KARAS	0	C-129	KARAS	0	C-129	KARAS	0	C-129	KARAS	0	C-129	KARAS	0	C-129
ZHANG	0			WAZ			ZHANG			0						ZHANG	
BYE	0	C-130	SAWADA	0	C-130	SAWADA	0	C-130	SAWADA	0	C-130	SAWADA	0	C-130	SAWADA	0	C-130
SAWADA	0			SAVOIE			10			IPC			SAVOIE			0	
BARDAI	0	C-131	BARDAI	0	C-131	BARDAI	0	C-131	BARDAI	0	C-131	BARDAI	0	C-131	BARDAI	0	C-131
BYE	0			SAVOIE			0						SAVOIE			0	
BARDAI	0	C-131	BARDAI	0	C-131	BARDAI	0	C-131	BARDAI	0	C-131	BARDAI	0	C-131	BARDAI	0	C-131
KO	10			IPC			KO			0						KO	
BARDAI	0	C-131	BARDAI	0	C-131	BARDAI	0	C-131	BARDAI	0	C-131	BARDAI	0	C-131	BARDAI	0	C-131
KO	10			IPC			KO			0						KO	

SW -63 kg

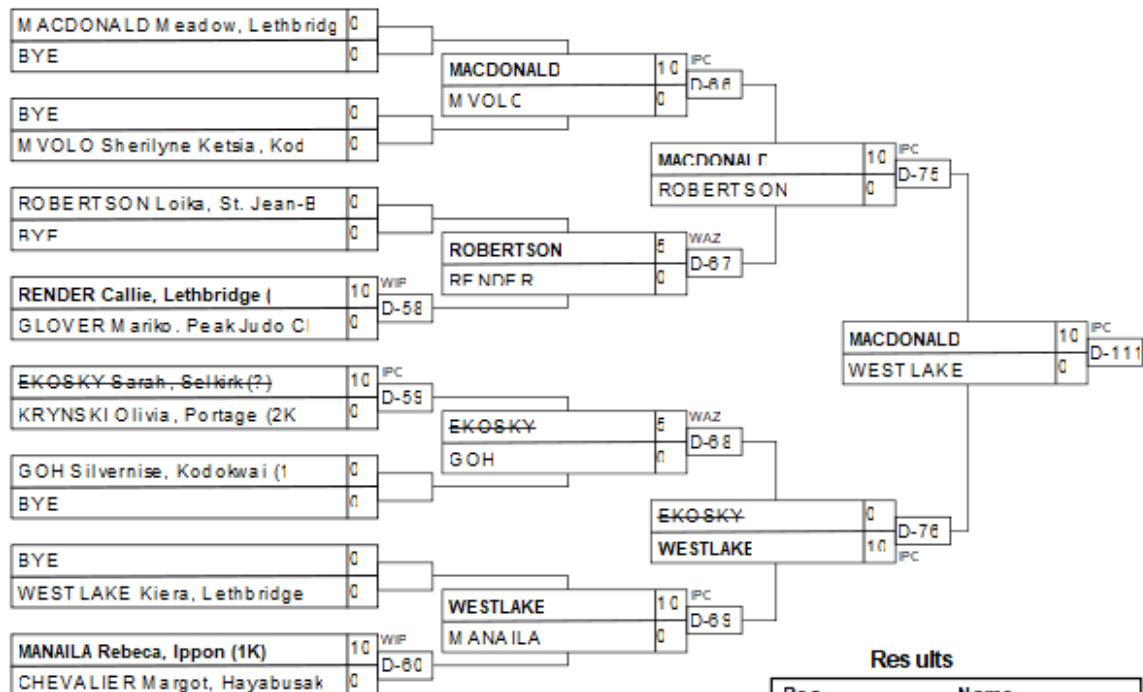

Results

Pos	Name
1	MACDONALD Meadow, Lethbr
2	WESTLAKE Kiera, Lethbrid
3	MANAILA Rebeca, Ippon (1
3	RENDER Callie, Lethbrid

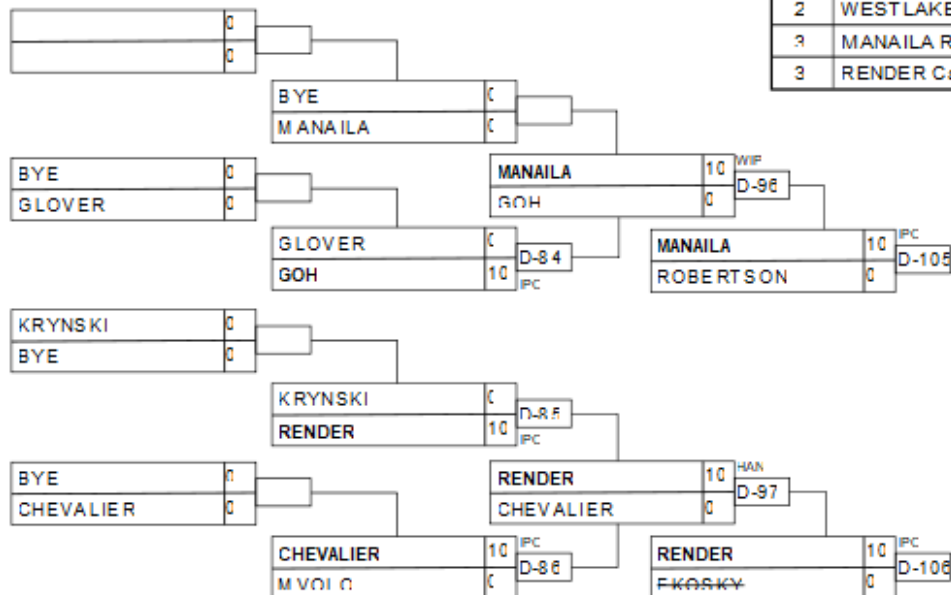

SW -70 kg

Competitors A

#	Name	Grade	Club	1	2	3	4	Wins	Pts	Pos
1	SOUSA Amanda	1D	Nakamura	XX		10		1	10	3
2	BIRON Laurence	1K	Varenes	10	XX	10	10	3	30	1
3	MORISHO Nyota	1D	Knkushika			XX		0	0	4
4	GILL Loane	?	Mtropolitain	10		10	XX	2	20	2

Pool A

Match	White	Blue	Result	Time	Code
A-118	SOUSA Amanda	BIRON Laurence	0 - 10	2:04	IPO
A-119	MORISHO Nyota	GILL Loane	0 - 10	1:34	IPO
A-127	SOUSA Amanda	MORISHO Nyota	10 - 0	0:30	IPO
A-128	BIRON Laurence	GILL Loane	10 - 0	1:14	IPO
A-140	SOUSA Amanda	GILL Loane	0 - 10	0:16	IPO
A-141	BIRON Laurence	MORISHO Nyota	10 - 0	1:02	IPO

Competitors B

#	Name	Grade	Club	5	6	7	Wins	Pts	Pos
5	VILLA Rebecca	1K	Nakamura	XX			0	0	3
6	SIMARD Justine	4K	Mtropolitain	10	XX	10	2	20	1
7	LEFORT Alexandria	1D	Sheffield	10		XX	1	10	2

Pool B

Match	White	Blue	Result	Time	Code
A-120	VILLA Rebecca	SIMARD Justine	0 - 10	0:30	IPO
A-129	VILLA Rebecca	LEFORT Alexandria	0 - 10	4:00	IPO
A-142	SIMARD Justine	LEFORT Alexandria	10 - 0	2:45	WIF

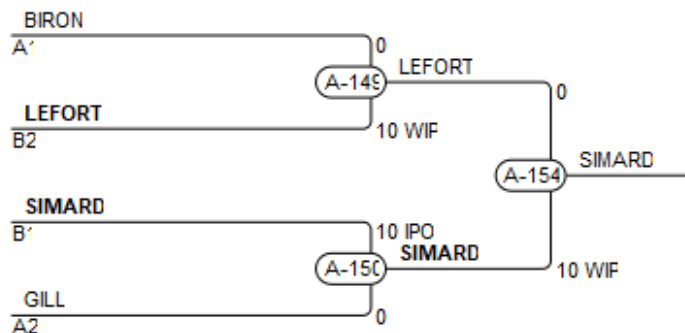

Results

Pos	Name
1	SIMARD Justine, Mtropolitain
2	LEFORT Alexandria, Sheffield
3	BIRON Laurence, Varenes
3	GILL Loane, Mtropolitain

SW +78 kg

Competitors

#	Name	Grade	Club	1	2	3	4	Wins	Pts	Pos
1	HENSON Kylee	1D	Mountainside	XX	10			1	10	3
2	HAMMER Inga	5K+	Regina Y		XX			0	0	4
3	MCALPINE Amanda	1D	Full Circle	10	5	XX		2	15	2
4	LINGLEY Brand	1K	Tani Ko	10	10	10	XX	3	30	1

Matches

Match	White		Blue	Result	Time	Code
C-139A	HENSON Kylee	1	2 HAMMER Inga	10 - 0	0:32	WIF
C-139B	MCALPINE Amanda	3	4 LINGLEY Brandi	0 - 10	3:15	HAN
C-143A	HENSON Kylee	1	3 MCALPINE Amanda	0 - 10	1:27	IPO
C-143B	HAMMER Inga	2	4 LINGLEY Brandi	0 - 10	1:47	IPO
C-147A	HENSON Kylee	1	4 LINGLEY Brandi	0 - 10	0:29	IPO
C-147B	HAMMER Inga	2	3 MCALPINE Amanda	0 - 5	6:0'	GSW

Results

Pos	Name
1	LINGLEY Brandi, Tani Ko
2	MCALPINE Amanda, Full Circle
3	HENSON Kylee, Mountainside

U16F -40 kg

Competitors

#	Name	Grade	Club	1	2	1	2	1	2	Wins	Pts	Pos
1	ANTOSH Megan	?	Port Coquitlam	XX		XX		XX		0	0	2
2	SAVOIE Marisol	?	Club Judo Otosh	10	XX	10	XX		XX	2	20	1

Matches

Match	White			Blue	Result	Time	Code
B-34	ANTOSH Megan	1	2	SAVOIE Marisol	0 - 10	0:59	WIF
B-46	SAVOIE Marisol	2	1	ANTOSH Megan	10 - 0	2:49	IPO
B-54	ANTOSH Megan	1	2	SAVOIE Marisol			

Results

Pos	Name
1	SAVOIE Marisol, Club Judo Otosh

U16F -48 kg

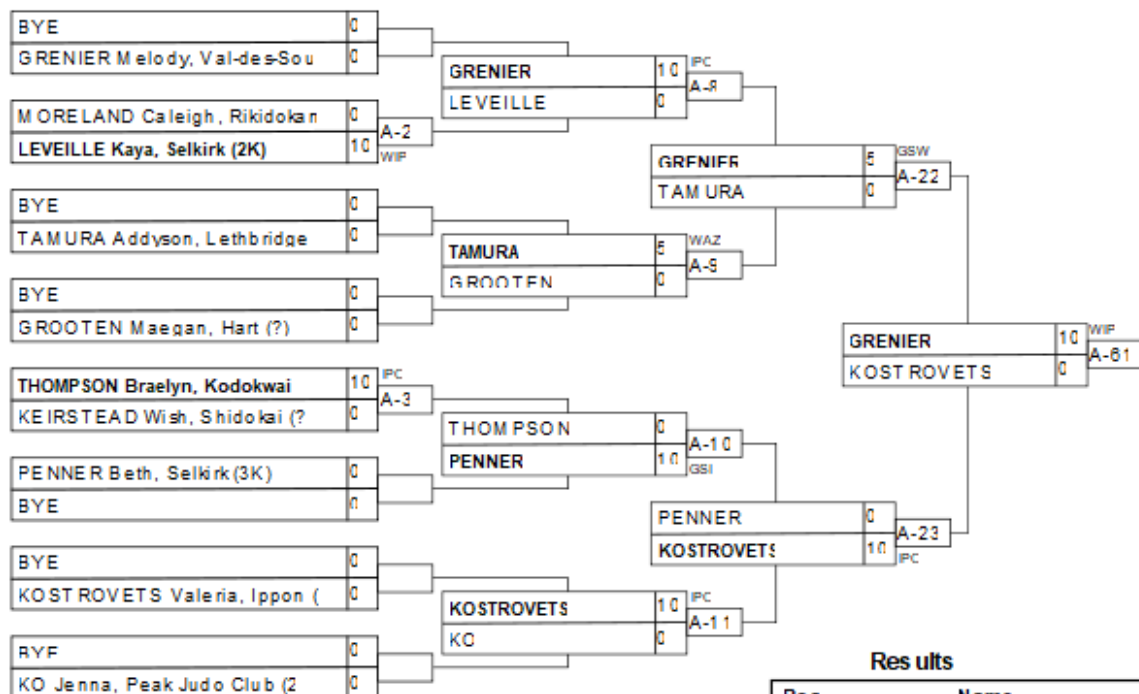

Results

Pos	Name
1	GRENIER Melody, Val-des-
2	KOSTROVETS Valeria, Ippo
3	KO Jenna, Peak Judo Club
3	GROOTEN Maegan, Hart (?)

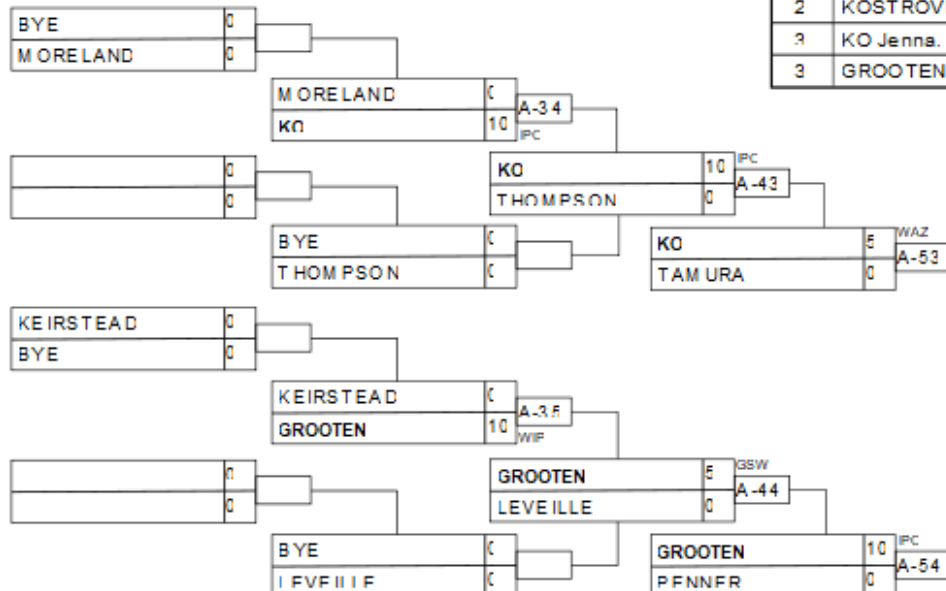

U16F -52 kg

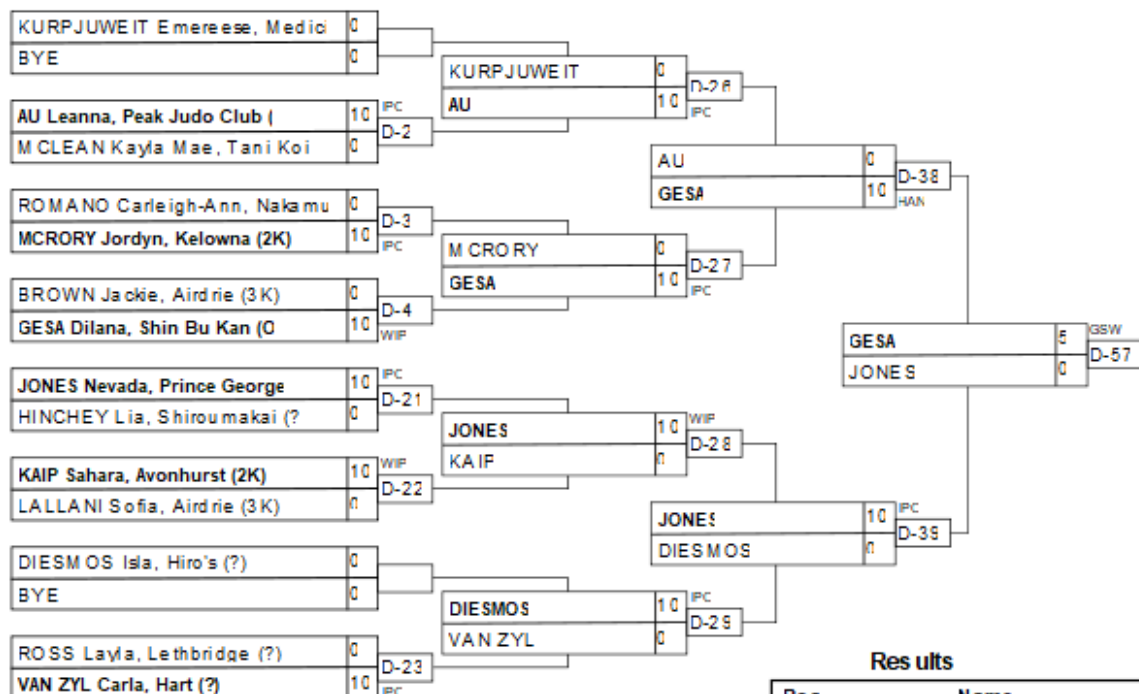

Results

Pos	Name
1	GESA Dilana, Shin Bu Kan
2	JONES Nevada, Prince Geo
3	AU Leanna, Peak Judo Clu
	DIEMOS Isla, Hiro's (?)

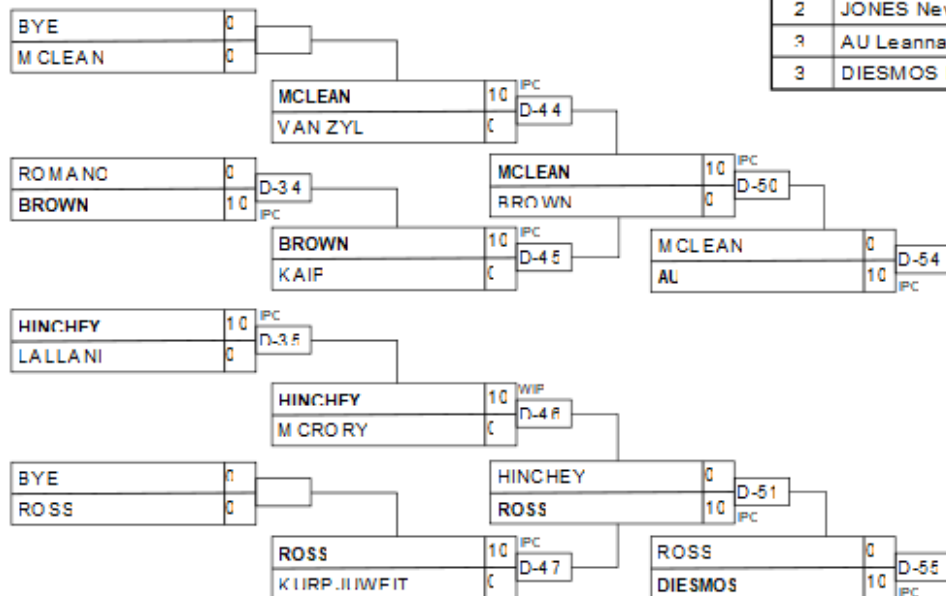

U16F -57 kg

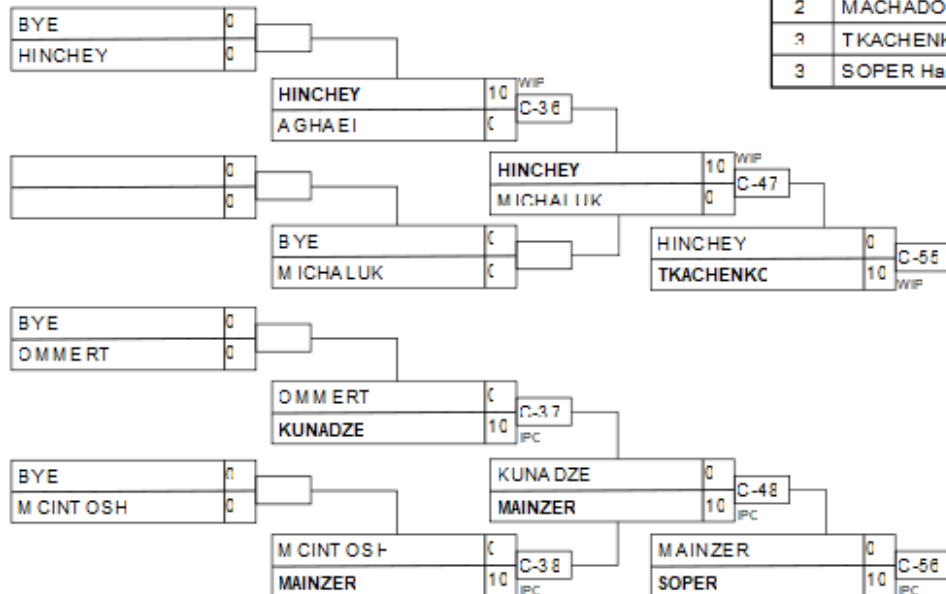
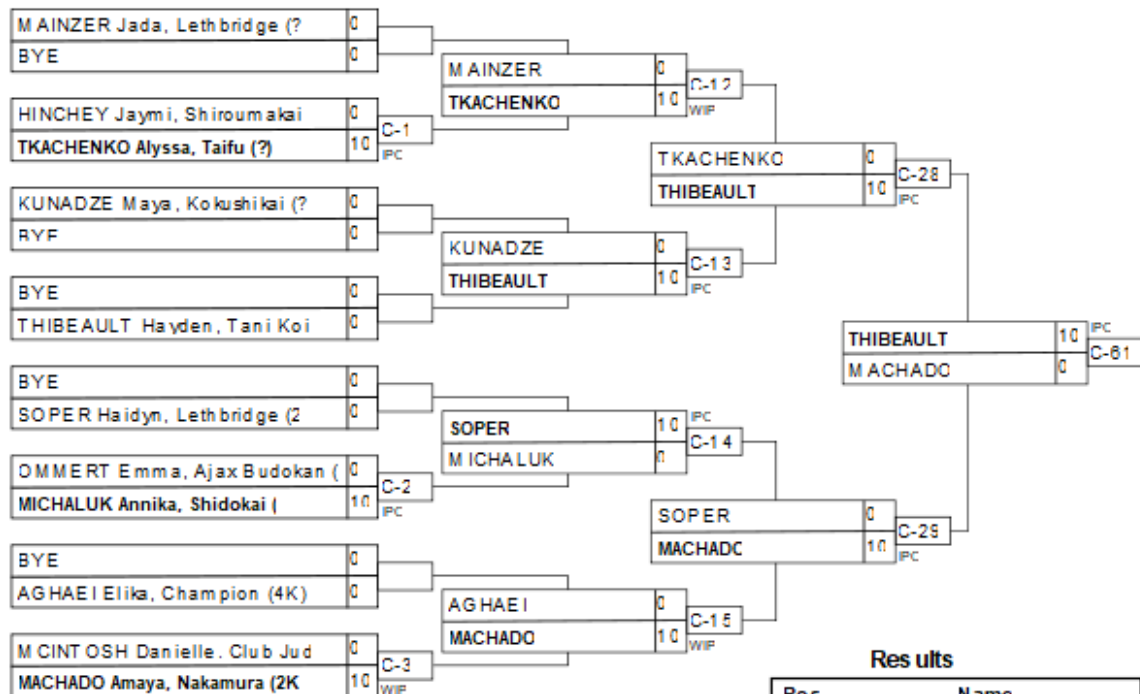

U16F -63 kg

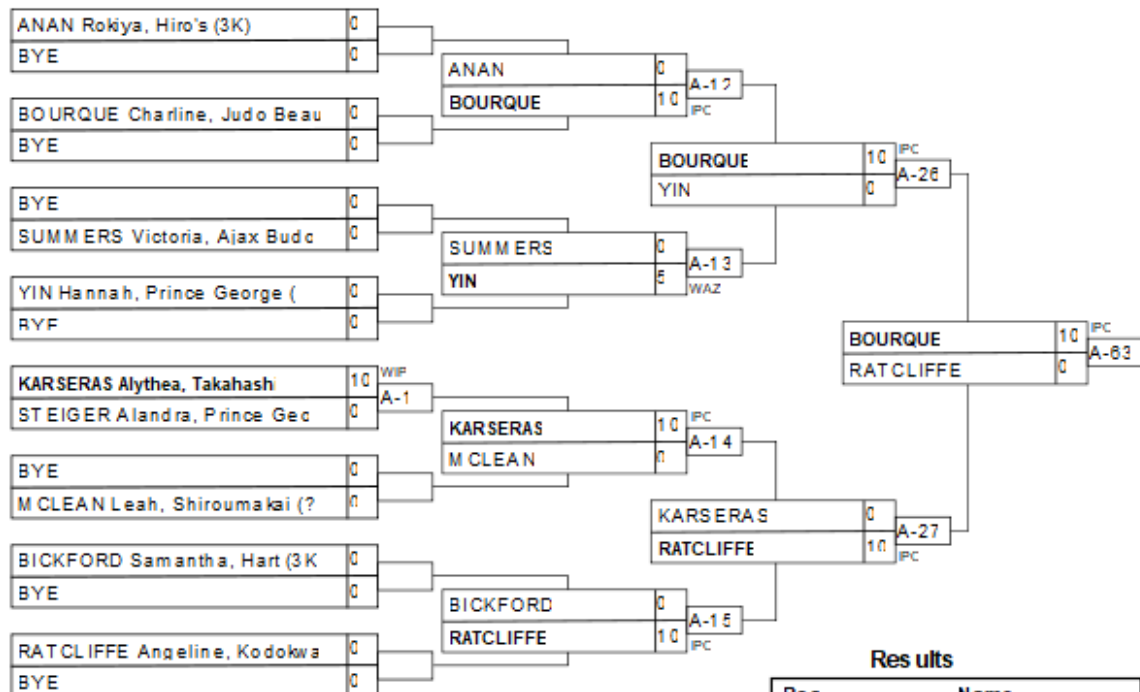

Results

Pos	Name
1	BOURQUE Charline, Judo B
2	RATCLIFFE Angeline, Kodo
3	YIN Hannah, Prince Georg
3	KARSERAS Alythea, Takaha

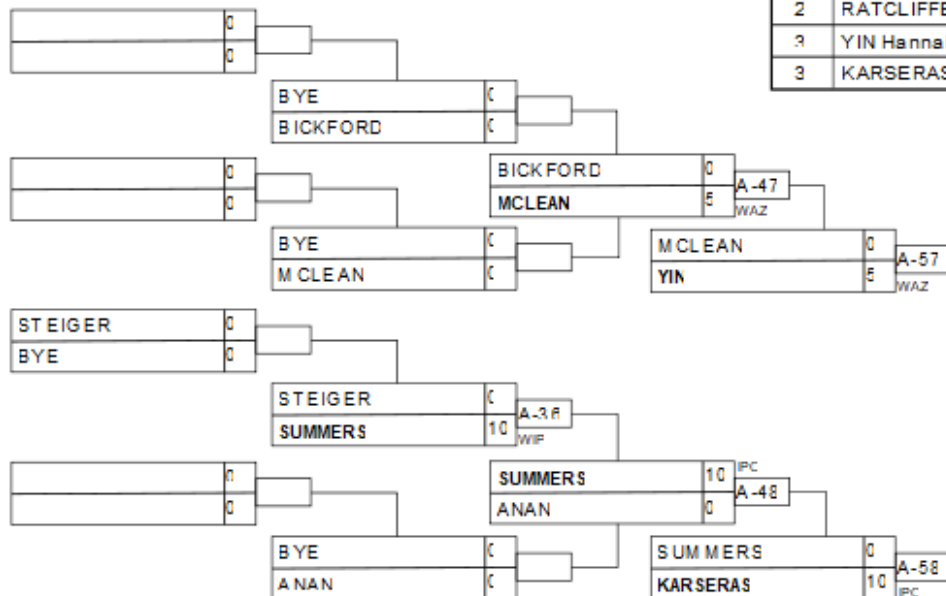

U16F -70 kg

Competitors A

#	Name	Grade	Club	1	2	3	Wins	Pts	Pos
1	ALIYEVA Emiliya	3K	Hiro's	XX	10	10	2	20	1
2	DESJARLAIS Abigail	2K	Prince George		XX	10	1	10	2
3	STEWART McKenna	2K	Saskirk			XX	0	0	3

Pool A

Match	White	Blue	Result	Time	Code
C-34	ALIYEVA Emiliya	1 2 DESJARLAIS Abigail	10 - 0	0:53	IPO
C-45	ALIYEVA Emiliya	1 3 STEWART McKenna	10 - 0	0:41	WIF
C-53	DESJARLAIS Abigail	2 3 STEWART McKenna	10 - 0	1:45	IPO

Competitors B

#	Name	Grade	Club	4	5	6	Wins	Pts	Pos
4	GALLANT Madison	2	Lethbridge	XX	10		1	10	2
5	LITCHFIELD Isabe	2	Barracuda		XX		0	0	3
6	MCCULLOUGH Lily	2K	Prince George	10	10	XX	2	20	1

Pool B

Match	White	Blue	Result	Time	Code
C-35	GALLANT Madison	4 5 LITCHFIELD Isabe	10 - 0	0:42	WIF
C-46	GALLANT Madison	4 6 MCCULLOUGH Lily	0 - 10	1:56	IPO
C-54	LITCHFIELD Isabe	5 6 MCCULLOUGH Lily	0 - 10	1:28	WIF

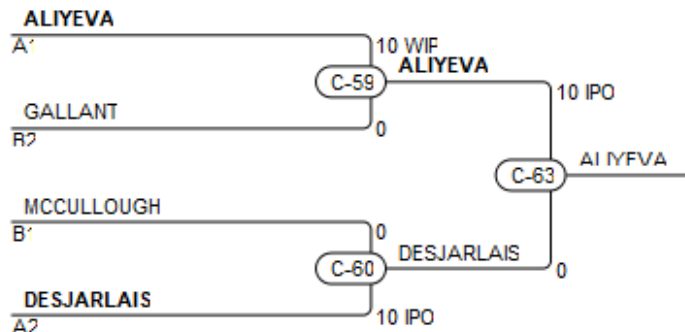

Results

Pos	Name
1	ALIYEVA Emiliya, Hiro's
2	DESJARLAIS Abigail, Prince George
3	GALLANT Madison, Lethbridge
3	MCCULLOUGH Lily, Prince George

U16F +70 kg

Competitors

#	Name	Grade	Club	1	2	1	2	1	2	Wins	Pts	Pos
1	FOWLER Naom	?	Tani Ko	XX	10	XX		XX		1	10	2
2	HRYNIW Jasmyne	3K	Tolide		XX	10	XX	10	XX	2	20	1

Matches

Match	White			Blue	Result	Time	Code
D-5	FOWLER Naomi	1	2	HRYNIW Jasmyne	10 - 0	0:06	IPO
D-15	HRYNIW Jasmyne	2	1	FOWLER Naom	10 - 0	0:06	IPO
D-20	FOWLER Naom	1	2	HRYNIW Jasmyne	0 - 10	0:23	IPO

Results

Pos	Name
1	HRYNIW Jasmyne, Tolide
2	FOWLER Naomi, Tani Ko

U16M -38 kg

Competitors

#	Name	Grade	Club	1	2	3	4	5	Wins	Pts	Pos
1	SEMYROZUM Roman	3K	Ippon	XX	10	10	10	10	4	40	1
2	BRIGGS Huxley	4K	Northern Lights		XX		10		1	10	4
3	GRACHTCHOUK Ivan	2K	Challenge		10	XX	10	10	3	30	2
4	HILLMAN Jackson	3K+	Abbotsford				XX		0	0	5
5	LOLIEV Akhmed	3K+	Peak Judo Club		5		10	XX	2	15	3

Matches

Match	White	White	Blue	Result	Time	Code	
C-16	HILLMAN Jackson	4	5	LOLIEV Akhmed	0 - 10	1:11	WIF
C-17	SEMYROZUM Roman	1	2	BRIGGS Huxley	10 - 0	0:09	IPO
C-22	GRACHTCHOUK Ivan	3	4	HILLMAN Jackson	10 - 0	0:10	IPO
C-23	SEMYROZUM Roman	1	5	LOLIEV Akhmed	10 - 0	6:15	GS
C-30	BRIGGS Huxley	2	3	GRACHTCHOUK Ivan	0 - 10	0:49	WIF
C-31	SEMYROZUM Roman	1	4	HILLMAN Jackson	10 - 0	0:46	WIF
C-39	GRACHTCHOUK Ivan	3	5	LOLIEV Akhmed	10 - 0	1:05	WIF
C-40	BRIGGS Huxley	2	4	HILLMAN Jackson	10 - 0	0:49	IPO
C-49	SEMYROZUM Roman	1	3	GRACHTCHOUK Ivan	10 - 0	2:37	HAN
C-50	BRIGGS Huxley	2	5	LOLIEV Akhmed	0 - 5	3:00	WAZ

Results

Pos	Name
1	SEMYROZUM Roman, Ippon
2	GRACHTCHOUK Ivan, Challenge
3	LOLIEV Akhmed, Peak Judo Club
4	BRIGGS Huxley, Northern Lights

U16M -42 kg

Competitors A

#	Name	Grade	Club	1	2	3	4	Wins	Pts	Pos
1	ROITMAN Arel	3K+	Taifu	XX	10	10	10	3	30	1
2	KO Logan	3K	Peak Judo Club		XX	10		1	10	3
3	MCLEAN Elias	3K+	Tani Ko			XX		0	0	4
4	WEBBER Justin	?	Hiro's		10	10	XX	2	20	2

Pool A

Match	White	Blue	Result	Time	Code
A-16	ROITMAN Arel	1 2 KO Logan	10 - 0	0:30	WIF
A-17	MCLEAN Elias	3 4 WEBBER Justin	0 - 10	0:24	IPO
A-28	ROITMAN Arel	1 3 MCLEAN Elias	10 - 0	1:05	IPO
A-29	KO Logan	2 4 WEBBER Justin	0 - 10	2:56	WIF
A-37	ROITMAN Arel	1 4 WEBBER Justin	10 - 0	5:11	HAN
A-38	KO Logan	2 3 MCLEAN Elias	10 - 0	2:06	IPO

Competitors B

#	Name	Grade	Club	5	6	7	Wins	Pts	Pos
5	RAMSEY Max	?	Kelowna	XX			0	0	3
6	NELSON Paxton	?	Avonhurst	10	XX		1	10	2
7	ROBERGE-POITRAS Samuel	?	Baie-Comeau	10	5	XX	2	15	1

Pool B

Match	White	Blue	Result	Time	Code
A-18	RAMSEY Max	5 6 NELSON Paxton	0 - 10	0:55	WIF
A-30	RAMSEY Max	5 7 ROBERGE-POITRAS Samuel	0 - 10	0:10	IPO
A-39	NELSON Paxton	6 7 ROBERGE-POITRAS Samuel	0 - 5	3:00	WAZ

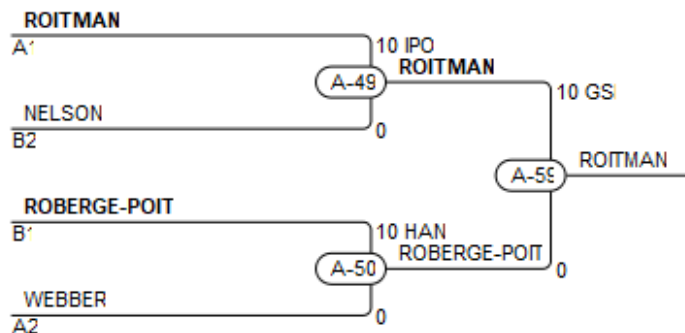

Results

Pos	Name
1	ROITMAN Arel, Taifu
2	ROBERGE-POITRAS Samuel, Baie-Comeau
3	NELSON Paxton, Avonhurst
3	WEBBER Justin, Hiro's

U16M -46 kg

Competitors A

#	Name	Grade	Club	1	2	3	4	Wins	Pts	Pos
1	TALBOT Machie	2K	Baie-Comeau	XX				0	0	4
2	SCHESNUIK Matthew	2K	ON Development	10	XX	10	10	3	30	1
3	TOUAIBIA Dali	?K	Club Judo Otosh	10		XX		1	10	3
4	TEMIRBAEV Amir	?	Peak Judo Club	10		5	XX	2	15	2

Pool A

Match	White	Blue	Result	Time	Code
B-31	TALBOT Machie	1 2 SCHESNUIK Matthew	0 - 10	1:10	IPO
B-32	TOUAIBIA Dali	3 4 TEMIRBAEV Amir	0 - 5	3:00	WAZ
B-43	TALBOT Machie	1 3 TOUAIBIA Dalil	0 - 10	0:00	FUS
B-44	SCHESNUIK Matthew	2 4 TEMIRBAEV Amir	10 - 0	3:00	IPO
B-51	TALBOT Machie	1 4 TEMIRBAEV Amir	0 - 10	0:00	FUS
B-52	SCHESNUIK Matthew	2 3 TOUAIBIA Dali	10 - 0	1:00	IPO

Competitors B

#	Name	Grade	Club	5	6	7	Wins	Pts	Pos
5	HINTON Tobin	?	Police Jr.	XX			0	0	3
6	PAMPOLINA Avery	3K	Nakamura	5	XX	10	2	15	1
7	MCALPINE Jack	3K	Medicine Hat	10		XX	1	10	2

Pool B

Match	White	Blue	Result	Time	Code
B-33	HINTON Tobin	5 6 PAMPOLINA Avery	0 - 5	0:37	WAZ
B-45	HINTON Tobin	5 7 MCALPINE Jack	0 - 10	1:09	IPO
B-53	PAMPOLINA Avery	6 7 MCALPINE Jack	10 - 0	1:13	IPO

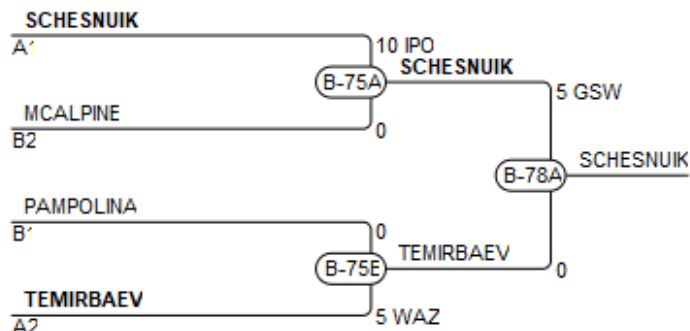

Results

Pos	Name
1	SCHESNUIK Matthew, ON Development
2	TEMIRBAEV Amir, Peak Judo Club
3	MCALPINE Jack, Medicine Hat
3	PAMPOLINA Avery, Nakamura

U16M -46 kg Tie Breaker (B)

Competitors

#	Name	Grade	Club	1	2	3	Wins	Pts	Pos
1	HINTON Tobin	2	Police Jr.	XX			0	0	3
2	PAMPOLINA Avery	3K	Nakamura	5	XX	10	2	15	1
3	MCALPINE Jack	3K	Medicine Hat	10		XX	1	10	2

Matches

Match	White			Blue	Result	Time	Code
E-1	HINTON Tobin	1	2	PAMPOLINA Avery	0 - 5	0:16	GSW
E-2	HINTON Tobin	1	3	MCALPINE Jack	0 - 10	0:12	GS
E-3	PAMPOLINA Avery	2	3	MCALPINE Jack	10 - 0	0:37	GS

Results

Pos	Name
1	PAMPOLINA Avery, Nakamura
2	MCALPINE Jack, Medicine Hat

U16M -50 kg

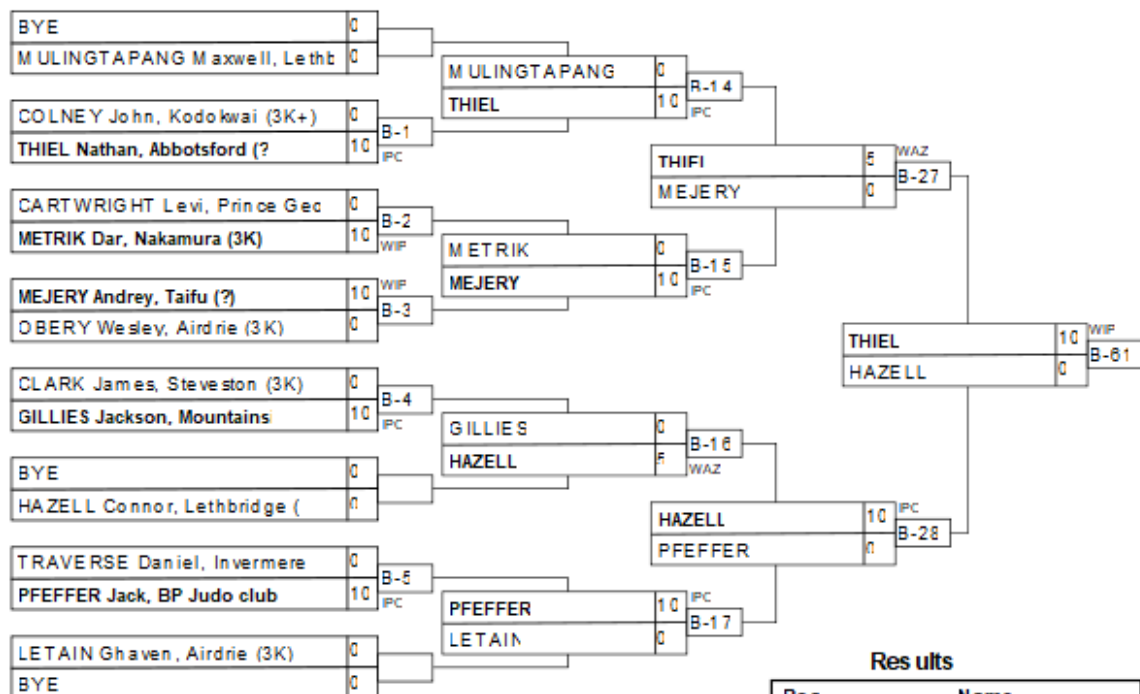

Results

Pos	Name
1	THIEL Nathan, Abbotsford
2	HAZELL Connor, Lethbridg
3	MEJERY Andrey, Taifu (?)
3	MULINGTAPANG Maxwell, Le

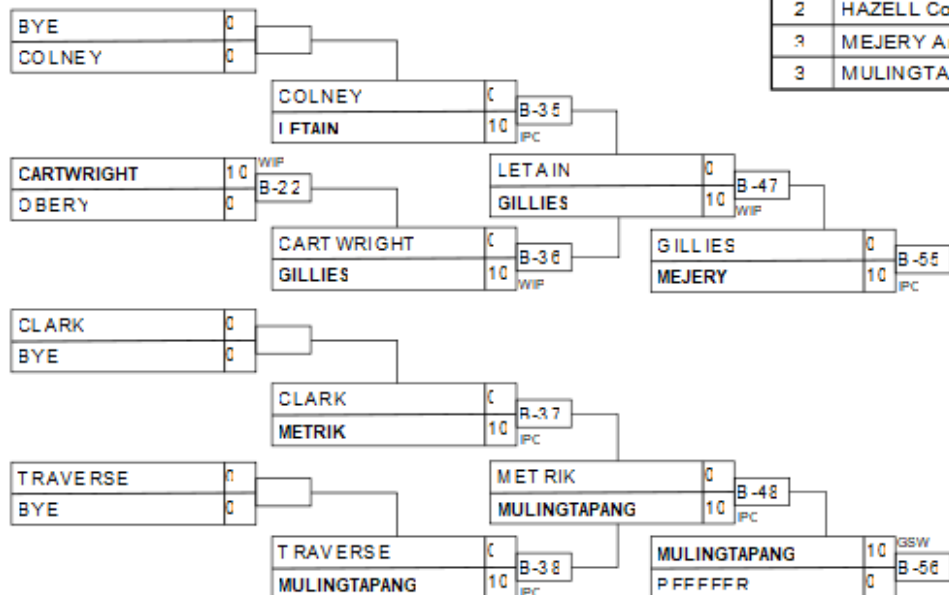

U16M -55 kg

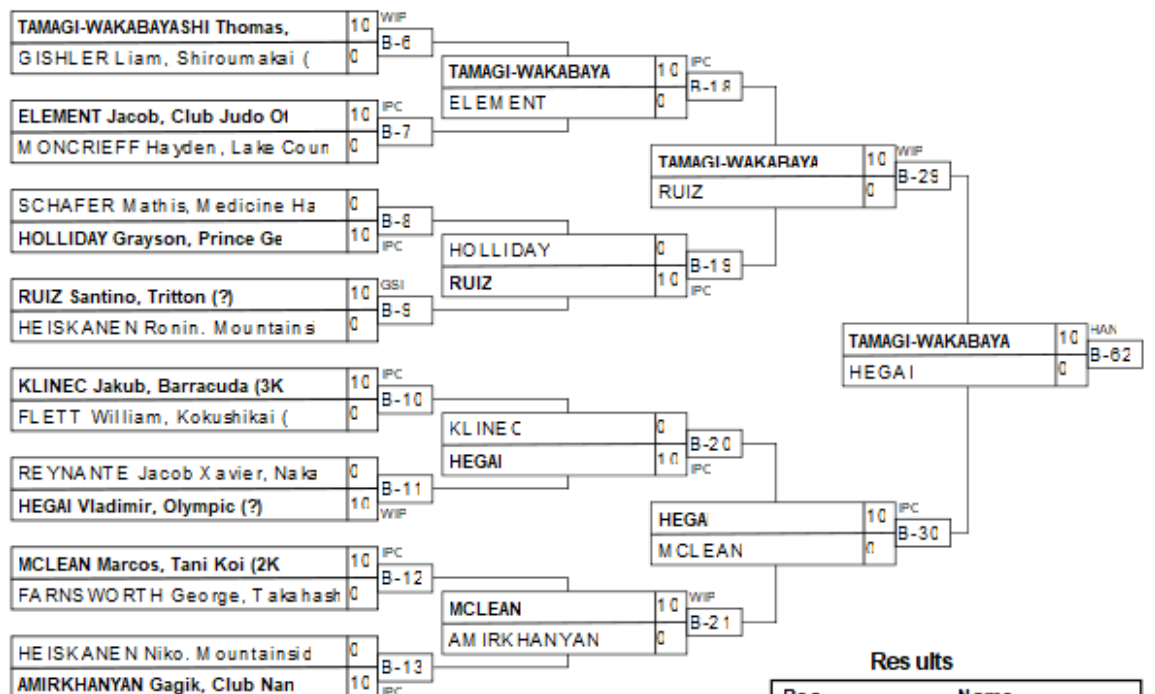

Results

Pos	Name
1	TAMAGI-WAKABAYASHI Thomas
2	HEGAI Vladimir, Olympic
3	AMIRKHANYAN Gagik, Club
3	ELEMENT Jacob, Club Judo

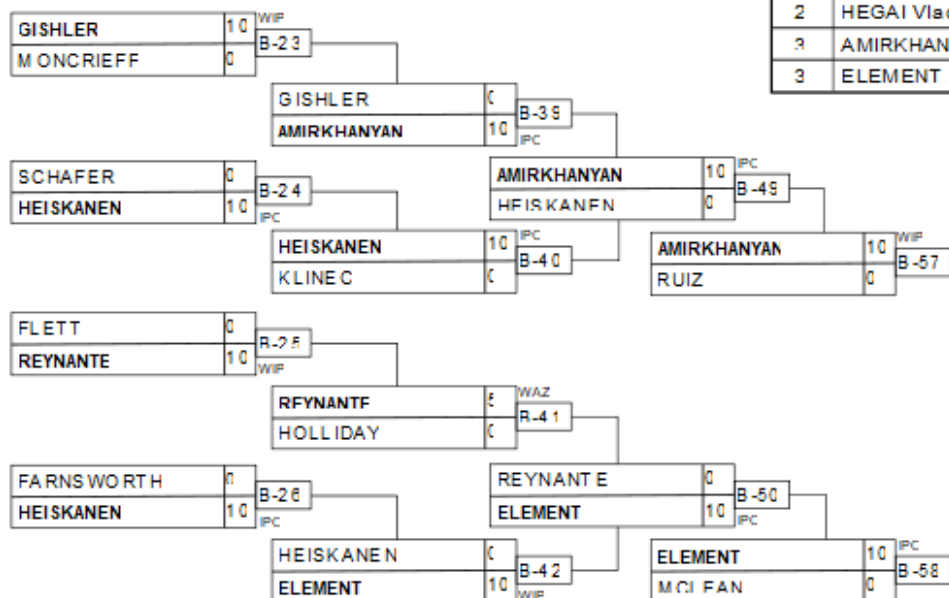

U16M -60 kg

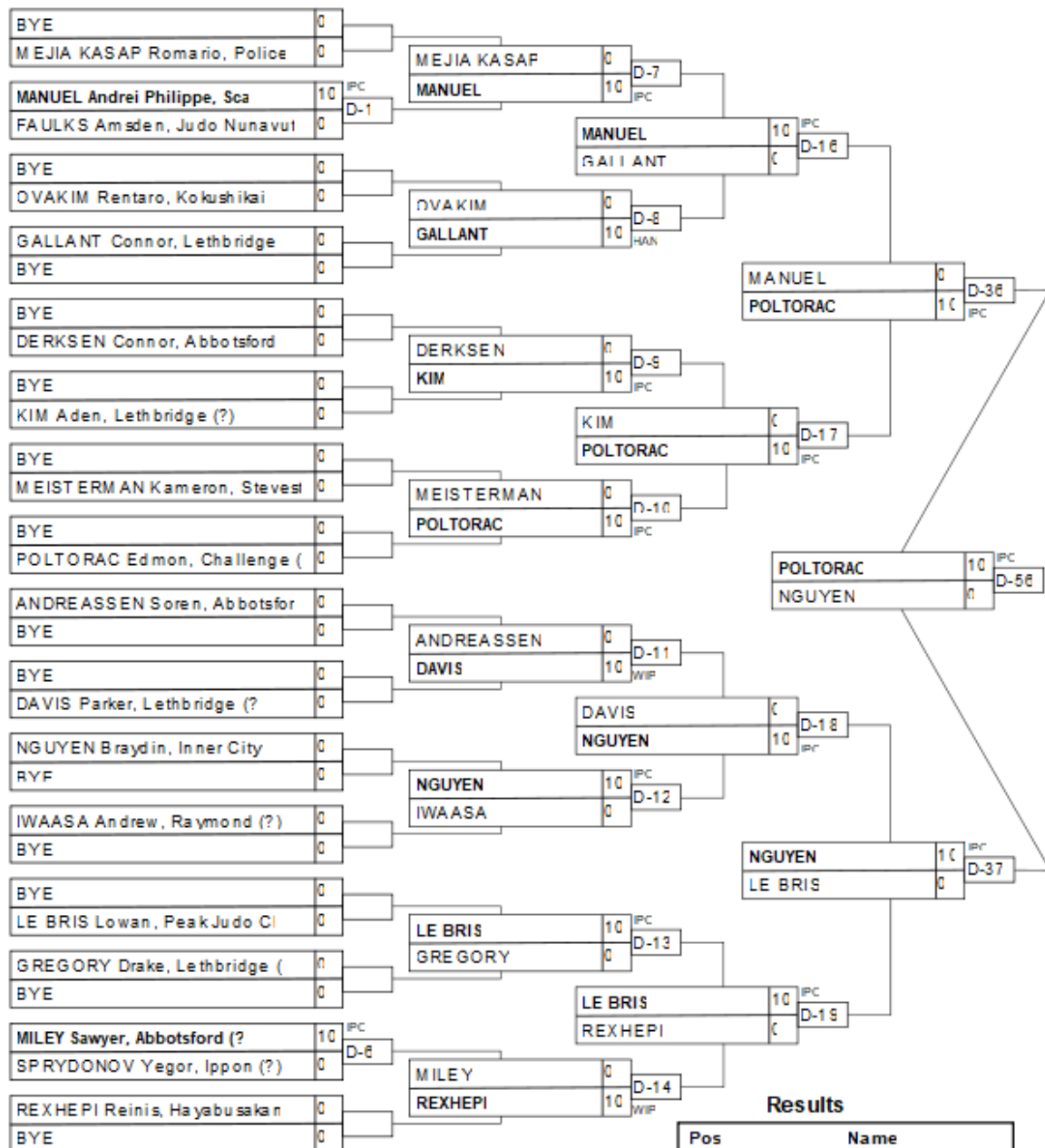

Results

Pos	Name
1	POLTORAC Edmon, Challeng
2	NGUYEN Braydin, Inner Ci
3	MANUEL Andrei Philippe,
3	LE BRIS Lowan, Peak Judo

U16M -66 kg

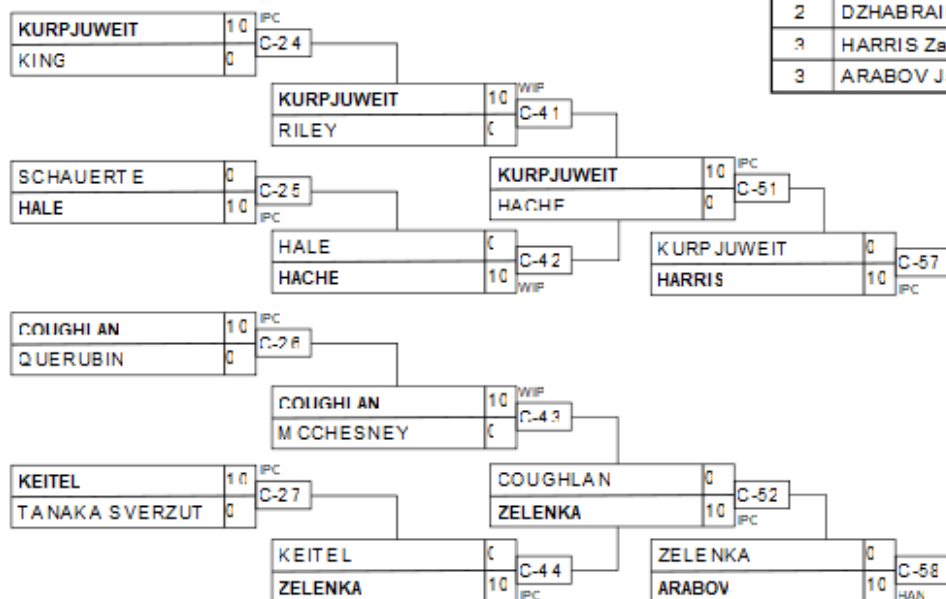
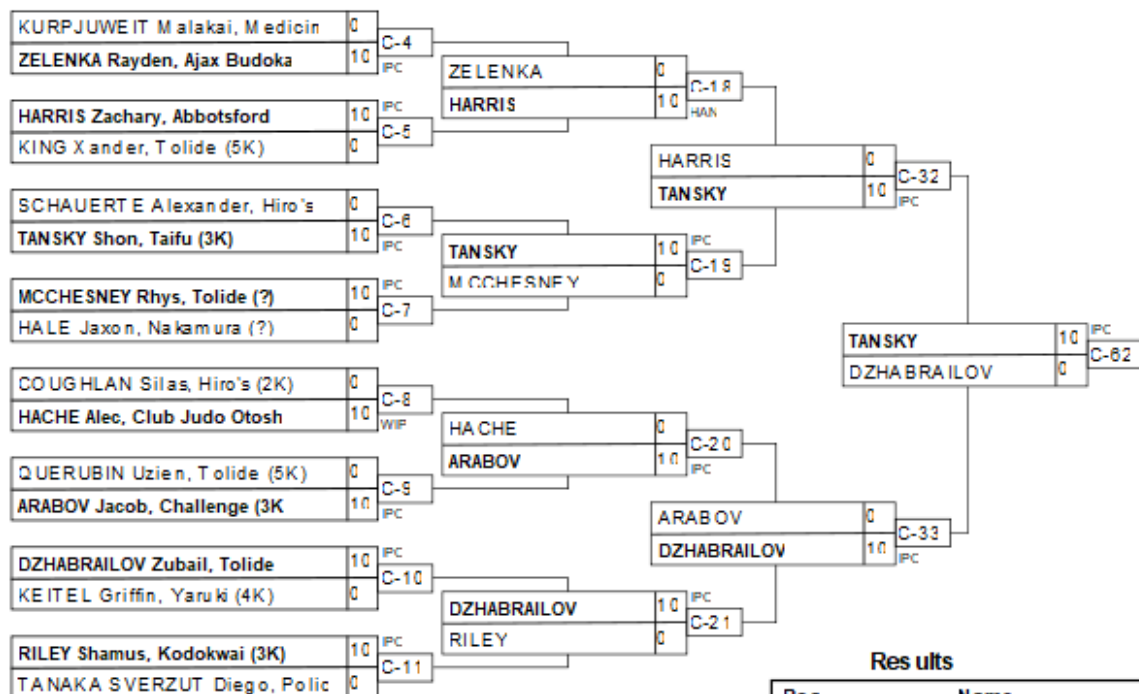

U16M -73 kg

Competitors A

#	Name	Grade	Club	1	2	3	4	Wins	Pts	Pos
1	SOKOLOV Elisey	2K	Taifu	XX	10	10	10	3	30	1
2	BOURGOIN Maxime	?	Club Judo Otosh		XX	10	10	2	20	2
3	ALTHOUSE Sawyer	1K	Lethbridge			XX	10	1	10	3
4	SAID MOHAMMOD Amir	4K	Kodokwa				XX	0	0	4

Pool A

Match	White	Blue	Result	Time	Code
A-19	SOKOLOV Elisey	1 2 BOURGOIN Maxime	10 - 0	0:35	IPO
A-20	ALTHOUSE Sawyer	3 4 SAID MOHAMMOD Amir	10 - 0	0:23	IPO
A-31	SOKOLOV Elisey	1 3 ALTHOUSE Sawyer	10 - 0	2:14	IPO
A-32	BOURGOIN Maxime	2 4 SAID MOHAMMOD Amir	10 - 0	1:02	IPO
A-40	SOKOLOV Elisey	1 4 SAID MOHAMMOD Amir	10 - 0	0:21	IPO
A-41	BOURGOIN Maxime	2 3 ALTHOUSE Sawyer	10 - 0	0:20	IPO

Competitors B

#	Name	Grade	Club	5	6	7	Wins	Pts	Pos
5	BATBAYAR Munkhu	2K	Lethbridge	XX	10	10	2	20	1
6	HOOVER Owen	2K	Kodokwa		XX	10	1	10	2
7	WHITMORE Gavin	?	Abbotsford			XX	0	0	3

Pool B

Match	White	Blue	Result	Time	Code
A-21	BATBAYAR Munkhu	5 6 HOOVER Owen	10 - 0	0:41	WIF
A-33	BATBAYAR Munkhu	5 7 WHITMORE Gavin	10 - 0	0:00	IPO
A-42	HOOVER Owen	6 7 WHITMORE Gavin	10 - 0	0:00	IPO

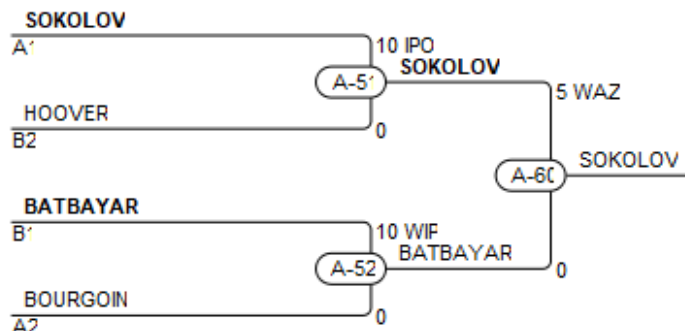

Results

Pos	Name
1	SOKOLOV Elisey, Taifu
2	BATBAYAR Munkhu, Lethbridge
3	HOOVER Owen, Kodokwa
3	BOURGOIN Maxime, Club Judo Otosh

U16M +73 kg

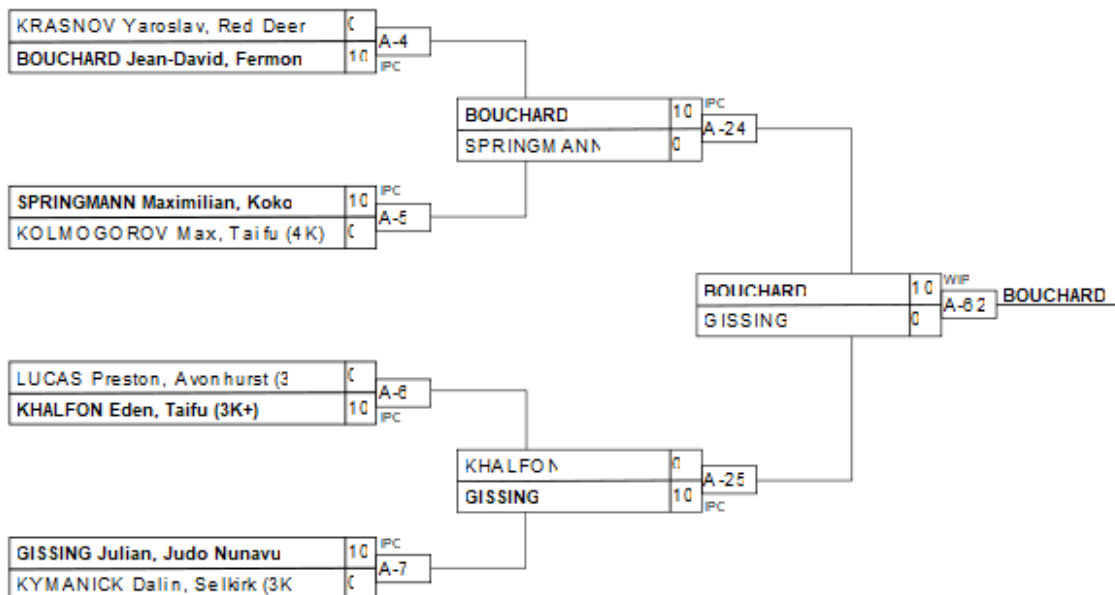

Results

Pos	Name
1	BOUCHARD Jean-David, Fer
2	GISSING Julian, Judo Nun
3	SPRINGMANN Maximilian, K
3	KHALFON Eden, Taifu (3K+)

