

F1 (30+) -57 kg

Competitors/Compétiteurs

#	Name/Nom	Club	1	2	1	2	1	2	W/G	Pts	Pos
1	GELINAS Isabelle	BC	XX	10	XX	10	XX		2	20	1
2	TRUONG Susan	ON		XX		XX		XX	0	0	2

Matches/Matches

Match	White/Blanc			Blue/Bleu	Res/Rés	Tim/Tmp	Code
D-76	GELINAS Isabelle	1	2	TRUONG Susan	10 - 0	0:00	FUS
D-82	TRUONG Susan	2	1	GELINAS Isabelle	0 - 10	0:00	FUS
D-88	GELINAS Isabelle	1	2	TRUONG Susan			

Results/Résultats

Pos	Name/Nom
1	GELINAS Isabelle, BC

F1 (30+) -70 kg

Competitors/Compétiteurs

#	Name/Nom	Club	1	2	1	2	1	2	W/G	Pts	Pos
1	RUSHTON Jodi	BC	XX		XX		XX		0	0	2
2	HEISSLER Annaliese	ON	10	XX	10	XX		XX	2	20	1

Matches/Matches

Match	White/Blanc			Blue/Bleu	Res/Rés	Tim/Tmp	Code
D-77	RUSHTON Jodi	1	2	HEISSLER Annaliese	0 - 10	0:44	WIP
D-83	HEISSLER Annaliese	2	1	RUSHTON Jodi	10 - 0	0:24	IPO
D-89	RUSHTON Jodi	1	2	HEISSLER Annaliese			

Results/Résultats

Pos	Name/Nom
1	HEISSLER Annaliese, ON

F1 (30+) +70 kg

Competitors/Compétiteurs

#	Name/Nom	Club	1	2	1	2	1	2	W/G	Pts	Pos
1	CHRIST Sonia	MB	XX		XX		XX		0	0	2
2	VALLEJO Chelys	SK	10	XX	10	XX		XX	2	20	1

Matches/Matches

Match	White/Blanc			Blue/Bleu	Res/Rés	Tim/Tmp	Code
A-63	CHRIST Sonia	1	2	VALLEJO Chelys	0 - 10	1:07	IPO
A-66	VALLEJO Chelys	2	1	CHRIST Sonia	10 - 0	2:31	IPO
A-69	CHRIST Sonia	1	2	VALLEJO Chelys			

Results/Résultats

Pos	Name/Nom
1	VALLEJO Chelys, SK

M1 (30-34) -81 kg

Competitors/Compétiteurs

#	Name/Nom	Club	1	2	3	4	W/G	Pts	Pos
1	BOOTHMAN Jordan	AB	XX	10	10		2	20	2
2	DUTTON Cole	AB		XX	10		1	10	3
3	LAROCHELLE Christian	AB			XX		0	0	4
4	O'BRIEN Kyle	AB	10	10	10	XX	3	30	1

Matches/Matches

Match	White/Blanc			Blue/Bleu	Res/Rés	Tim/Tmp	Code
B-68	BOOTHMAN Jordan	1	2	DUTTON Cole	10 - 0	1:29	IPO
B-69	LAROCHELLE Christian	3	4	O'BRIEN Kyle	0 - 10	1:39	IPO
B-75	BOOTHMAN Jordan	1	3	LAROCHELLE Christian	10 - 0	0:00	KIK
B-76	DUTTON Cole	2	4	O'BRIEN Kyle	0 - 10	0:52	IPO
B-82	BOOTHMAN Jordan	1	4	O'BRIEN Kyle	0 - 10	0:47	WIP
B-83	DUTTON Cole	2	3	LAROCHELLE Christian	10 - 0	0:00	KIK

Results/Résultats

Pos	Name/Nom
1	O'BRIEN Kyle, AB
2	BOOTHMAN Jordan, AB
3	DUTTON Cole, AB

M1 (30-34) +81 kg

Competitors/Compétiteurs

#	Name/Nom	Club	1	2	3	W/G	Pts	Pos
1	DAUPHINEE Shane	AB	XX	10		1	10	2
2	PAXMAN Eric	AB		XX		0	0	3
3	CHIN Justin	ON	10	10	XX	2	20	1

Matches/Matches

Match	White/Blanc			Blue/Bleu	Res/Rés	Tim/Tmp	Code
A-62	DAUPHINEE Shane	1	2	PAXMAN Eric	10 - 0	0:31	IPO
A-65	DAUPHINEE Shane	1	3	CHIN Justin	0 - 10	2:08	IPO
A-68	PAXMAN Eric	2	3	CHIN Justin	0 - 10	2:17	IPO

Results/Résultats

Pos	Name/Nom
1	CHIN Justin, ON
2	DAUPHINEE Shane, AB

M2 (35-39) +81 kg

Competitors/Compétiteurs

#	Name/Nom	Club	1	2	3	4	5	W/G	Pts	Pos
1	RUPERT Danny	AB	XX		10		10	2	20	3
2	WOOD Adam	AB	10	XX	10		10	3	30	2
3	WHITE Justin	AB			XX	10		1	10	5
4	TURNER Richard	AB	10	10		XX	10	3	30	1
5	MACLEAN Anthony	AB			10		XX	1	10	4

Matches/Matches

Match	White/Blanc			Blue/Bleu		Res/Rés	Tim/Tmp	Code
D-70	TURNER Richard	4	5	MACLEAN Anthony		10 - 0	0:39	IPO
D-71	RUPERT Danny	1	2	WOOD Adam		0 - 10	1:11	WIP
D-72	WHITE Justin	3	4	TURNER Richard		10 - 0	1:05	IPO
D-73	RUPERT Danny	1	5	MACLEAN Anthony		10 - 0	3:00	WIP
D-78	WOOD Adam	2	3	WHITE Justin		10 - 0	1:59	IPO
D-79	RUPERT Danny	1	4	TURNER Richard		0 - 10	0:19	IPO
D-84	WHITE Justin	3	5	MACLEAN Anthony		0 - 10	0:57	IPO
D-85	WOOD Adam	2	4	TURNER Richard		0 - 10	0:32	IPO
D-90	RUPERT Danny	1	3	WHITE Justin		10 - 0	1:19	WIP
D-91	WOOD Adam	2	5	MACLEAN Anthony		10 - 0	0:58	IPO

Results/Résultats

Pos	Name/Nom
1	TURNER Richard, AB
2	WOOD Adam, AB
3	RUPERT Danny, AB
4	MACLEAN Anthony, AB
5	WHITE Justin, AB

M3 (40-44) -66 kg

Competitors/Compétiteurs

#	Name/Nom	Club	1	2	3	W/G	Pts	Pos
1	KWOK Matthew	AB	XX		10	1	10	2
2	BALDONADO Billy-Joe	AB	10	XX	10	2	20	1
3	KOBES Terrance	AB			XX	0	0	3

Matches/Matches

Match	White/Blanc			Blue/Bleu	Res/Rés	Tim/Tmp	Code
A-61	KWOK Matthew	1	2	BALDONADO Billy-Joe	0 - 10	0:29	IPO
A-64	KWOK Matthew	1	3	KOBES Terrance	10 - 0	3:00	IPO
A-67	BALDONADO Billy-Joe	2	3	KOBES Terrance	10 - 0	0:13	IPO

Results/Résultats

Pos	Name/Nom
1	BALDONADO Billy-Joe, AB
2	KWOK Matthew, AB

M3 (40-44) -81 kg

Competitors/Compétiteurs

#	Name/Nom	Club	1	2	3	4	W/G	Pts	Pos
1	CROWELL Kyle	AB	XX		10	10	2	20	2
2	ZALESKIKH Ivan	AB	10	XX	10	10	3	30	1
3	CAMPOS Jaime	MB			XX	10	1	10	3
4	MACLEOD David	AB				XX	0	0	4

Matches/Matches

Match	White/Blanc			Blue/Bleu	Res/Rés	Tim/Tmp	Code
D-74	CROWELL Kyle	1	2	ZALESKIKH Ivan	0 - 10	0:13	IPO
D-75	CAMPOS Jaime	3	4	MACLEOD David	10 - 0	0:00	FUS
D-80	CROWELL Kyle	1	3	CAMPOS Jaime	10 - 0	1:09	WIP
D-81	ZALESKIKH Ivan	2	4	MACLEOD David	10 - 0	0:45	IPO
D-86	CROWELL Kyle	1	4	MACLEOD David	10 - 0	1:07	IPO
D-87	ZALESKIKH Ivan	2	3	CAMPOS Jaime	10 - 0	1:05	IPO

Results/Résultats

Pos	Name/Nom
1	ZALESKIKH Ivan, AB
2	CROWELL Kyle, AB
3	CAMPOS Jaime, MB

M3 (40-44) +81 kg

Competitors/Compétiteurs

#	Name/Nom	Club	1	2	3	4	5	W/G	Pts	Pos
1	NICA Victor	AB	XX	10	10	10		3	30	2
2	HENRY Shaun	BC		XX				0	0	5
3	URGILES Fernando	ON		10	XX			1	10	4
4	KURPJUWEIT Robin	AB		10	10	XX		2	20	3
5	PIVOVAR Mark	AB	10	10	10	10	XX	4	40	1

Matches/Matches

Match	White/Blanc			Blue/Bleu	Res/Rés	Tim/Tmp	Code
B-64	KURPJUWEIT Robin	4	5	PIVOVAR Mark	0 - 10	0:45	IPO
B-65	NICA Victor	1	2	HENRY Shaun	10 - 0	0:42	IPO
B-66	URGILES Fernando	3	4	KURPJUWEIT Robin	0 - 10	2:47	HAN
B-67	NICA Victor	1	5	PIVOVAR Mark	0 - 10	1:29	IPO
B-73	HENRY Shaun	2	3	URGILES Fernando	0 - 10	2:59	IPO
B-74	NICA Victor	1	4	KURPJUWEIT Robin	10 - 0	0:46	IPO
B-80	URGILES Fernando	3	5	PIVOVAR Mark	0 - 10	0:16	IPO
B-81	HENRY Shaun	2	4	KURPJUWEIT Robin	0 - 10	1:47	IPO
B-87	NICA Victor	1	3	URGILES Fernando	10 - 0	0:55	IPO
B-88	HENRY Shaun	2	5	PIVOVAR Mark	0 - 10	0:58	WIP

Results/Résultats

Pos	Name/Nom
1	PIVOVAR Mark, AB
2	NICA Victor, AB
3	KURPJUWEIT Robin, AB
4	URGILES Fernando, ON

M4 (45-49) -81 kg

Competitors/Compétiteurs

#	Name/Nom	Club	1	2	3	4	W/G	Pts	Pos
1	SMILEY Christopher	BC	XX	10	10	5	3	25	1
2	SERHAN James	BC		XX			0	0	4
3	BRIGGS Bernard	YT		10	XX		1	10	3
4	SAINT-MARTIN Marc	AB		10	10	XX	2	20	2

Matches/Matches

Match	White/Blanc			Blue/Bleu	Res/Rés	Tim/Tmp	Code
B-70	SMILEY Christopher	1	2	SERHAN James	10 - 0	0:41	IPO
B-71	BRIGGS Bernard	3	4	SAINT-MARTIN Marc	0 - 10	0:40	WIP
B-77	SMILEY Christopher	1	3	BRIGGS Bernard	10 - 0	0:14	IPO
B-78	SERHAN James	2	4	SAINT-MARTIN Marc	0 - 10	1:27	WIP
B-84	SMILEY Christopher	1	4	SAINT-MARTIN Marc	5 - 0	6:03	GSW
B-85	SERHAN James	2	3	BRIGGS Bernard	0 - 10	2:07	IPO

Results/Résultats

Pos	Name/Nom
1	SMILEY Christopher, BC
2	SAINT-MARTIN Marc, AB
3	BRIGGS Bernard, YT

M4 (45-49) +81 kg

Competitors/Compétiteurs

#	Name/Nom	Club	1	2	3	4	W/G	Pts	Pos
1	POTTS Shad	BC	XX	10		10	2	20	2
2	CRYER Chris	BC		XX		10	1	10	3
3	TREMBLAY Simon	AB	10	10	XX	10	3	30	1
4	KENNEDY Christopher	AB				XX	0	0	4

Matches/Matches

Match	White/Blanc			Blue/Bleu	Res/Rés	Tim/Tmp	Code
C-70	POTTS Shad	1	2	CRYER Chris	10 - 0	0:44	IPO
C-71	TREMBLAY Simon	3	4	KENNEDY Christopher	10 - 0	0:00	FUS
C-73	POTTS Shad	1	3	TREMBLAY Simon	0 - 10	0:16	WIP
C-74	CRYER Chris	2	4	KENNEDY Christopher	10 - 0	0:00	FUS
C-76	POTTS Shad	1	4	KENNEDY Christopher	10 - 0	0:00	FUS
C-77	CRYER Chris	2	3	TREMBLAY Simon	0 - 10	0:17	IPO

Results/Résultats

Pos	Name/Nom
1	TREMBLAY Simon, AB
2	POTTS Shad, BC
3	CRYER Chris, BC

M5 (50+) -66 kg

Competitors/Compétiteurs

#	Name/Nom	Club	1	2	1	2	1	2	W/G	Pts	Pos
1	TAKAHASHI Tim	AB	XX	10	XX	10	XX		2	20	1
2	MAACH Taoufik	AB		XX		XX		XX	0	0	2

Matches/Matches

Match	White/Blanc			Blue/Bleu	Res/Rés	Tim/Tmp	Code
C-72	TAKAHASHI Tim	1	2	MAACH Taoufik	10 - 0	0:00	FUS
C-75	MAACH Taoufik	2	1	TAKAHASHI Tim	0 - 10	0:00	FUS
C-78	TAKAHASHI Tim	1	2	MAACH Taoufik			

Results/Résultats

Pos	Name/Nom
1	TAKAHASHI Tim, AB

M5 (50+) +81 kg

Competitors/Compétiteurs

#	Name/Nom	Club	1	2	3	W/G	Pts	Pos
1	COUGHLAN Craig	AB	XX		10	1	10	2
2	ELHEGAZY Hesham	AB	10	XX	10	2	20	1
3	DEMETER Sandor	MB			XX	0	0	3

Matches/Matches

Match	White/Blanc			Blue/Bleu	Res/Rés	Tim/Tmp	Code
B-90A	COUGHLAN Craig	1	2	ELHEGAZY Hesham	0 - 10	0:35	WIP
B-79	COUGHLAN Craig	1	3	DEMETER Sandor	10 - 0	1:25	IPO
B-86	ELHEGAZY Hesham	2	3	DEMETER Sandor	10 - 0	0:28	IPO

Results/Résultats

Pos	Name/Nom
1	ELHEGAZY Hesham, AB
2	COUGHLAN Craig, AB

U10 Group 1

Competitors/Compétiteurs

#	Name/Nom	Club	1	2	3	4	W/G	Pts	Pos
1	MOMOT Melania	AB	XX	5			1	5	3
2	MANDRUSIAK Sara	AB		XX	5		1	5	4
3	BERNIER Crozzley	BC	5		XX		1	5	2
4	ROTH Erik	AB	5	5	5	XX	3	15	1

Matches/Matches

Match	White/Blanc			Blue/Bleu	Res/Rés	Tim/Tmp	Code
D-1	MOMOT Melania	1	2	MANDRUSIAK Sara	5 - 0	2:00	WAZ
D-2	BERNIER Crozzley	3	4	ROTH Erik	0 - 5	2:00	WAZ
D-9	MOMOT Melania	1	3	BERNIER Crozzley	0 - 5	2:00	WAZ
D-10	MANDRUSIAK Sara	2	4	ROTH Erik	0 - 5	2:00	WAZ
D-17	MOMOT Melania	1	4	ROTH Erik	0 - 5	2:00	WAZ
D-18	MANDRUSIAK Sara	2	3	BERNIER Crozzley	5 - 0	2:00	WAZ

Results/Résultats

Pos	Name/Nom
1	ROTH Erik, AB
2	BERNIER Crozzley, BC
2	MOMOT Melania, AB
2	MANDRUSIAK Sara, AB

U10 Group 2

Competitors/Compétiteurs

#	Name/Nom	Club	1	2	3	4	W/G	Pts	Pos
1	LESSARD Chloe	AB	XX	10			1	10	3
2	CAMPBELL-KILBORN Kerra	AB		XX	5	10	2	15	2
3	JORDAN Christina	BC	10		XX	10	2	20	1
4	FLEMING Ryder	AB	5			XX	1	5	4

Matches/Matches

Match	White/Blanc		Blue/Bleu	Res/Rés	Tim/Tmp	Code	
A-1	LESSARD Chloe	1	2	CAMPBELL-KILBORN Kerra	10 - 0	2:00	IPO
A-2	JORDAN Christina	3	4	FLEMING Ryder	10 - 0	0:07	IPO
A-9	LESSARD Chloe	1	3	JORDAN Christina	0 - 10	0:00	IPO
A-10	CAMPBELL-KILBORN Kerra	2	4	FLEMING Ryder	10 - 0	2:00	IPO
A-17	LESSARD Chloe	1	4	FLEMING Ryder	0 - 5	2:00	WAZ
A-18	CAMPBELL-KILBORN Kerra	2	3	JORDAN Christina	5 - 0	2:00	WAZ

Results/Résultats

Pos	Name/Nom
1	JORDAN Christina, BC
2	CAMPBELL-KILBORN Kerra, AB
3	LESSARD Chloe, AB
4	FLEMING Ryder, AB

U10 Group 3

Competitors/Compétiteurs

#	Name/Nom	Club	1	2	3	4	W/G	Pts	Pos
1	ZALESKIKH Daniel	AB	XX		10		1	10	3
2	SHOPLAND Kahnle	AB	10	XX	10	10	3	30	1
3	VANDEMARK Maxen	BC			XX		0	0	4
4	KOBES Ava	AB	10		10	XX	2	20	2

Matches/Matches

Match	White/Blanc			Blue/Bleu	Res/Rés	Tim/Tmp	Code
B-1	ZALESKIKH Daniel	1	2	SHOPLAND Kahnle	0 - 10	2:00	IPO
B-2	VANDEMARK Maxen	3	4	KOBES Ava	0 - 10	2:00	IPO
B-10	ZALESKIKH Daniel	1	3	VANDEMARK Maxen	10 - 0	2:00	IPO
B-11	SHOPLAND Kahnle	2	4	KOBES Ava	10 - 0	2:00	IPO
B-19	ZALESKIKH Daniel	1	4	KOBES Ava	0 - 10	2:00	IPO
B-20	SHOPLAND Kahnle	2	3	VANDEMARK Maxen	10 - 0	2:00	IPO

Results/Résultats

Pos	Name/Nom
1	SHOPLAND Kahnle, AB
2	KOBES Ava, AB
3	ZALESKIKH Daniel, AB

U10 Group 4

Competitors/Compétiteurs

#	Name/Nom	Club	1	2	3	4	W/G	Pts	Pos
1	FABES Ava	AB	XX				0	0	4
2	DOBSON Luke	AB	5	XX			1	5	3
3	BOESE Jill	AB	5	5	XX		2	10	2
4	TAYLOR Bennett	AB	5	5	5	XX	3	15	1

Matches/Matches

Match	White/Blanc			Blue/Bleu	Res/Rés	Tim/Tmp	Code
D-3	FABES Ava	1	2	DOBSON Luke	0 - 5	2:00	WAZ
D-4	BOESE Jill	3	4	TAYLOR Bennett	0 - 5	2:00	WAZ
D-11	FABES Ava	1	3	BOESE Jill	0 - 5	2:00	WAZ
D-12	DOBSON Luke	2	4	TAYLOR Bennett	0 - 5	2:00	WAZ
D-19	FABES Ava	1	4	TAYLOR Bennett	0 - 5	2:00	WAZ
D-20	DOBSON Luke	2	3	BOESE Jill	0 - 5	1:49	WAZ

Results/Résultats

Pos	Name/Nom
1	TAYLOR Bennett, AB
2	BOESE Jill, AB
3	DOBSON Luke, AB

U10 Group 5

Competitors/Compétiteurs

#	Name/Nom	Club	1	2	3	4	W/G	Pts	Pos
1	HANTKE Greyson	AB	XX		5	10	2	15	2
2	SEEMAN Kamryn	AB	5	XX	10	10	3	25	1
3	MILLAR Chloe	AB			XX	5	1	5	3
4	THOMPSON Theon	AB				XX	0	0	4

Matches/Matches

Match	White/Blanc		Blue/Bleu	Res/Rés	Tim/Tmp	Code
C-3	HANTKE Greyson	1	2 SEEMAN Kamryn	0 - 5	2:00	WAZ
C-4	MILLAR Chloe	3	4 THOMPSON Theon	5 - 0	2:00	WAZ
C-11	HANTKE Greyson	1	3 MILLAR Chloe	5 - 0	1:13	WAZ
C-12	SEEMAN Kamryn	2	4 THOMPSON Theon	10 - 0	1:21	WIP
C-19	HANTKE Greyson	1	4 THOMPSON Theon	10 - 0	1:10	WIP
C-20	SEEMAN Kamryn	2	3 MILLAR Chloe	10 - 0	1:38	WIP

Results/Résultats

Pos	Name/Nom
1	SEEMAN Kamryn, AB
2	HANTKE Greyson, AB
3	MILLAR Chloe, AB

U10 Group 6

Competitors/Compétiteurs

#	Name/Nom	Club	1	2	3	W/G	Pts	Pos
1	REID Greyson	AB	XX	10	10	2	20	1
2	POHL Lyla	AB		XX	10	1	10	2
3	SAENZ EMMERSON Amaya	BC			XX	0	0	3

Matches/Matches

Match	White/Blanc			Blue/Bleu	Res/Rés	Tim/Tmp	Code
B-3	REID Greyson	1	2	POHL Lyla	10 - 0	1:15	IPO
B-12	REID Greyson	1	3	SAENZ EMMERSON Amaya	10 - 0	2:00	IPO
B-21	POHL Lyla	2	3	SAENZ EMMERSON Amaya	10 - 0	2:00	IPO

Results/Résultats

Pos	Name/Nom
1	REID Greyson, AB
2	POHL Lyla, AB

U10 Group 7

Competitors/Compétiteurs

#	Name/Nom	Club	1	2	3	4	W/G	Pts	Pos
1	DERMAN Ava	AB	XX	5	5	5	3	15	1
2	COUILLARD Audrey	AB		XX	5	5	2	10	2
3	KOKKO Lennox	BC			XX	5	1	5	3
4	MARSHALL Finley	AB				XX	0	0	4

Matches/Matches

Match	White/Blanc			Blue/Bleu	Res/Rés	Tim/Tmp	Code
A-3	DERMAN Ava	1	2	COUILLARD Audrey	5 - 0	2:00	WAZ
A-4	KOKKO Lennox	3	4	MARSHALL Finley	5 - 0	2:00	WAZ
A-11	DERMAN Ava	1	3	KOKKO Lennox	5 - 0	2:00	WAZ
A-12	COUILLARD Audrey	2	4	MARSHALL Finley	5 - 0	2:00	WAZ
A-19	DERMAN Ava	1	4	MARSHALL Finley	5 - 0	2:00	WAZ
A-20	COUILLARD Audrey	2	3	KOKKO Lennox	5 - 0	2:00	WAZ

Results/Résultats

Pos	Name/Nom
1	DERMAN Ava, AB
2	COUILLARD Audrey, AB
3	KOKKO Lennox, BC

U10 Group 8

Competitors/Compétiteurs

#	Name/Nom	Club	1	2	3	4	W/G	Pts	Pos
1	GIESBRECHT Lydia	BC	XX				0	0	4
2	STURT Layla	BC	10	XX	10	10	3	30	1
3	BORAS Austin	AB	10		XX		1	10	3
4	ROSKEWICH Maxim	BC	10		10	XX	2	20	2

Matches/Matches

Match	White/Blanc		Blue/Bleu	Res/Rés	Tim/Tmp	Code	
B-4	GIESBRECHT Lydia	1	2	STURT Layla	0 - 10	2:00	IPO
B-5	BORAS Austin	3	4	ROSKEWICH Maxim	0 - 10	1:17	IPO
B-13	GIESBRECHT Lydia	1	3	BORAS Austin	0 - 10	2:00	IPO
B-14	STURT Layla	2	4	ROSKEWICH Maxim	10 - 0	2:00	IPO
B-22	GIESBRECHT Lydia	1	4	ROSKEWICH Maxim	0 - 10	2:00	IPO
B-23	STURT Layla	2	3	BORAS Austin	10 - 0	2:00	IPO

Results/Résultats

Pos	Name/Nom
1	STURT Layla, BC
2	ROSKEWICH Maxim, BC
3	BORAS Austin, AB

U10 Group 9

Competitors/Compétiteurs

#	Name/Nom	Club	1	2	3	4	W/G	Pts	Pos
1	HOHL Emerson	AB	XX				0	0	4
2	LAU Theodore	AB	5	XX	5		2	10	2
3	LIGHTFOOT Emma	BC	5		XX		1	5	3
4	DILIO Ryan	AB	5	5	5	XX	3	15	1

Matches/Matches

Match	White/Blanc			Blue/Bleu	Res/Rés	Tim/Tmp	Code
D-5	HOHL Emerson	1	2	LAU Theodore	0 - 5	2:00	WAZ
D-6	LIGHTFOOT Emma	3	4	DILIO Ryan	0 - 5	2:00	WAZ
D-13	HOHL Emerson	1	3	LIGHTFOOT Emma	0 - 5	2:00	WAZ
D-14	LAU Theodore	2	4	DILIO Ryan	0 - 5	2:00	WAZ
D-21	HOHL Emerson	1	4	DILIO Ryan	0 - 5	2:00	WAZ
D-22	LAU Theodore	2	3	LIGHTFOOT Emma	5 - 0	2:00	WAZ

Results/Résultats

Pos	Name/Nom
1	DILIO Ryan, AB
2	LAU Theodore, AB
3	LIGHTFOOT Emma, BC

U10 Group 10

Competitors/Compétiteurs

#	Name/Nom	Club	1	2	3	4	W/G	Pts	Pos
1	LESSARD Avery-Marie	AB	XX				0	0	4
2	CLAMPITT Edrik	AB	5	XX			1	5	3
3	PROCTOR Nate	BC	5	5	XX		2	10	2
4	DERMAN Kenzie	AB	10	5	5	XX	3	20	1

Matches/Matches

Match	White/Blanc		Blue/Bleu	Res/Rés	Tim/Tmp	Code	
C-5	LESSARD Avery-Marie	1	2	CLAMPITT Edrik	0 - 5	2:00	WAZ
C-6	PROCTOR Nate	3	4	DERMAN Kenzie	0 - 5	2:00	WAZ
C-13	LESSARD Avery-Marie	1	3	PROCTOR Nate	0 - 5	2:00	WAZ
C-14	CLAMPITT Edrik	2	4	DERMAN Kenzie	0 - 5	2:00	WAZ
C-21	LESSARD Avery-Marie	1	4	DERMAN Kenzie	0 - 10	1:49	WIP
C-22	CLAMPITT Edrik	2	3	PROCTOR Nate	0 - 5	2:00	WAZ

Results/Résultats

Pos	Name/Nom
1	DERMAN Kenzie, AB
2	PROCTOR Nate, BC
3	CLAMPITT Edrik, AB

U10 Group 11

Competitors/Compétiteurs

#	Name/Nom	Club	1	2	3	4	W/G	Pts	Pos
1	COCKS Lucas	AB	XX	5	5		2	10	1
2	OBERY Elliott	AB		XX		5	1	5	4
3	HENRY Dominic	BC		5	XX	5	2	10	2
4	SAGDIC Timur	POL	10			XX	1	10	3

Matches/Matches

Match	White/Blanc		Blue/Bleu	Res/Rés	Tim/Tmp	Code	
A-5	COCKS Lucas	1	2	OBERY Elliott	5 - 0	2:00	WAZ
A-6	HENRY Dominic	3	4	SAGDIC Timur	5 - 0	2:00	WAZ
A-13	COCKS Lucas	1	3	HENRY Dominic	5 - 0	2:00	WAZ
A-14	OBERY Elliott	2	4	SAGDIC Timur	5 - 0	2:00	WAZ
A-21	COCKS Lucas	1	4	SAGDIC Timur	0 - 10	2:00	IPO
A-22	OBERY Elliott	2	3	HENRY Dominic	0 - 5	2:00	WAZ

Results/Résultats

Pos	Name/Nom
1	COCKS Lucas, AB
2	HENRY Dominic, BC
3	SAGDIC Timur, POL
4	OBERY Elliott, AB

U10 Group 12

Competitors/Compétiteurs

#	Name/Nom	Club	1	2	3	4	W/G	Pts	Pos
1	MASSOP Ethan	AB	XX		10		1	10	3
2	BETTS Elijah	AB	10	XX	10		2	20	2
3	MCALPINE Atticus	AB			XX	10	1	10	4
4	SINCLAIR Mason	AB	10	10		XX	2	20	1

Matches/Matches

Match	White/Blanc		Blue/Bleu	Res/Rés	Tim/Tmp	Code	
B-6	MASSOP Ethan	1	2	BETTS Elijah	0 - 10	2:00	IPO
B-7	MCALPINE Atticus	3	4	SINCLAIR Mason	10 - 0	1:35	IPO
B-15	MASSOP Ethan	1	3	MCALPINE Atticus	10 - 0	2:00	IPO
B-16	BETTS Elijah	2	4	SINCLAIR Mason	0 - 10	2:00	IPO
B-24	MASSOP Ethan	1	4	SINCLAIR Mason	0 - 10	1:33	IPO
B-25	BETTS Elijah	2	3	MCALPINE Atticus	10 - 0	2:00	IPO

Results/Résultats

Pos	Name/Nom
1	SINCLAIR Mason, AB
2	BETTS Elijah, AB
3	MASSOP Ethan, AB
4	MCALPINE Atticus, AB

U10 Group 13

Competitors/Compétiteurs

#	Name/Nom	Club	1	2	3	4	W/G	Pts	Pos
1	ALDRED Colton	AB	XX				0	0	4
2	DAUPHINEE Caleb	AB	5	XX	5	5	3	15	1
3	SHEVCHENKO Yaroslav	BC	5		XX	5	2	10	2
4	BATBAYAR Anand	AB	5			XX	1	5	3

Matches/Matches

Match	White/Blanc			Blue/Bleu	Res/Rés	Tim/Tmp	Code
D-7	ALDRED Colton	1	2	DAUPHINEE Caleb	0 - 5	2:00	WAZ
D-8	SHEVCHENKO Yaroslav	3	4	BATBAYAR Anand	5 - 0	2:00	WAZ
D-15	ALDRED Colton	1	3	SHEVCHENKO Yaroslav	0 - 5	2:00	WAZ
D-16	DAUPHINEE Caleb	2	4	BATBAYAR Anand	5 - 0	2:00	WAZ
D-23	ALDRED Colton	1	4	BATBAYAR Anand	0 - 5	2:00	WAZ
D-24	DAUPHINEE Caleb	2	3	SHEVCHENKO Yaroslav	5 - 0	2:00	WAZ

Results/Résultats

Pos	Name/Nom
1	DAUPHINEE Caleb, AB
2	SHEVCHENKO Yaroslav, BC
3	BATBAYAR Anand, AB

U10 Group 14

Competitors/Compétiteurs

#	Name/Nom	Club	1	2	3	4	W/G	Pts	Pos
1	MACHATTIE Roman	AB	XX				0	0	4
2	MOHAN Jaxon	AB	5	XX			1	5	3
3	MEIRELLES Miguel	BC	5	10	XX	5	3	20	1
4	NICA Veronica	AB	10	5		XX	2	15	2

Matches/Matches

Match	White/Blanc			Blue/Bleu	Res/Rés	Tim/Tmp	Code
C-7	MACHATTIE Roman	1	2	MOHAN Jaxon	0 - 5	2:00	WAZ
C-8	MEIRELLES Miguel	3	4	NICA Veronica	5 - 0	2:00	WAZ
C-15	MACHATTIE Roman	1	3	MEIRELLES Miguel	0 - 5	2:00	WAZ
C-16	MOHAN Jaxon	2	4	NICA Veronica	0 - 5	2:00	WAZ
C-23	MACHATTIE Roman	1	4	NICA Veronica	0 - 10	1:24	WIP
C-24	MOHAN Jaxon	2	3	MEIRELLES Miguel	0 - 10	1:09	WIP

Results/Résultats

Pos	Name/Nom
1	MEIRELLES Miguel, BC
2	NICA Veronica, AB
3	MOHAN Jaxon, AB

U10 Group 15

Competitors/Compétiteurs

#	Name/Nom	Club	1	2	3	4	W/G	Pts	Pos
1	BJARNASON Aspen	AB	XX	5	5		2	10	3
2	TSE Dawson	AB		XX			0	0	4
3	LUNDSBYE Kurt	BC		5	XX	5	2	10	1
4	PINDER Rhys	AB	5	5		XX	2	10	2

Matches/Matches

Match	White/Blanc			Blue/Bleu	Res/Rés	Tim/Tmp	Code
A-7	BJARNASON Aspen	1	2	TSE Dawson	5 - 0	2:00	WAZ
A-8	LUNDSBYE Kurt	3	4	PINDER Rhys	5 - 0	2:00	WAZ
A-15	BJARNASON Aspen	1	3	LUNDSBYE Kurt	5 - 0	2:00	WAZ
A-16	TSE Dawson	2	4	PINDER Rhys	0 - 5	2:00	WAZ
A-23	BJARNASON Aspen	1	4	PINDER Rhys	0 - 5	2:00	WAZ
A-24	TSE Dawson	2	3	LUNDSBYE Kurt	0 - 5	2:00	WAZ

Results/Résultats

Pos	Name/Nom
1	LUNDSBYE Kurt, BC
1	PINDER Rhys, AB
1	BJARNASON Aspen, AB

U10 Group 16

Competitors/Compétiteurs

#	Name/Nom	Club	1	2	3	4	W/G	Pts	Pos
1	FELDMAN Solomon	AB	XX			10	1	10	3
2	CRAEVOI Alexis	AB	10	XX		10	2	20	2
3	WILSON Xavier	BC	10	10	XX	10	3	30	1
4	SEEMAN Zander	AB				XX	0	0	4

Matches/Matches

Match	White/Blanc		Blue/Bleu	Res/Rés	Tim/Tmp	Code	
B-8	FELDMAN Solomon	1	2	CRAEVOI Alexis	0 - 10	2:00	IPO
B-9	WILSON Xavier	3	4	SEEMAN Zander	10 - 0	2:00	IPO
B-17	FELDMAN Solomon	1	3	WILSON Xavier	0 - 10	2:00	IPO
B-18	CRAEVOI Alexis	2	4	SEEMAN Zander	10 - 0	2:00	IPO
B-26	FELDMAN Solomon	1	4	SEEMAN Zander	10 - 0	2:00	IPO
B-27	CRAEVOI Alexis	2	3	WILSON Xavier	0 - 10	2:00	IPO

Results/Résultats

Pos	Name/Nom
1	WILSON Xavier, BC
2	CRAEVOI Alexis, AB
3	FELDMAN Solomon, AB

U10 Group 17

Competitors/Compétiteurs

#	Name/Nom	Club	1	2	3	4	W/G	Pts	Pos
1	ZOOK Mack	AB	XX	10	10	5	3	25	1
2	ELHEGAZY Adam	AB		XX	5	10	2	15	2
3	SNIDER Khloe	SK			XX		0	0	4
4	HARDING David	AB			5	XX	1	5	3

Matches/Matches

Match	White/Blanc			Blue/Bleu	Res/Rés	Tim/Tmp	Code
C-1	ZOOK Mack	1	2	ELHEGAZY Adam	10 - 0	1:57	WIP
C-2	SNIDER Khloe	3	4	HARDING David	0 - 5	0:00	WAZ
C-9	ZOOK Mack	1	3	SNIDER Khloe	10 - 0	1:14	IPO
C-10	ELHEGAZY Adam	2	4	HARDING David	10 - 0	1:37	WIP
C-17	ZOOK Mack	1	4	HARDING David	5 - 0	2:00	WAZ
C-18	ELHEGAZY Adam	2	3	SNIDER Khloe	5 - 0	2:00	WAZ

Results/Résultats

Pos	Name/Nom
1	ZOOK Mack, AB
2	ELHEGAZY Adam, AB
3	HARDING David, AB

U12F Group 1

Competitors/Compétiteurs

#	Name/Nom	Club	1	2	3	4	W/G	Pts	Pos
1	THOMPSON Neveah	AB	XX				0	0	4
2	PROCTOR Ava	AB	5	XX			1	5	3
3	TANAPIMA Langus	BC	5	5	XX		2	10	2
4	SCHIMANN Zoe	BC	10	5	5	XX	3	20	1

Matches/Matches

Match	White/Blanc		Blue/Bleu	Res/Rés	Tim/Tmp	Code	
D-25	THOMPSON Neveah	1	2	PROCTOR Ava	0 - 5	2:00	WAZ
D-26	TANAPIMA Langus	3	4	SCHIMANN Zoe	0 - 5	2:00	WAZ
D-40	THOMPSON Neveah	1	3	TANAPIMA Langus	0 - 5	2:00	WAZ
D-41	PROCTOR Ava	2	4	SCHIMANN Zoe	0 - 5	2:00	WAZ
D-55	THOMPSON Neveah	1	4	SCHIMANN Zoe	0 - 10	1:07	IPO
D-56	PROCTOR Ava	2	3	TANAPIMA Langus	0 - 5	2:00	WAZ

Results/Résultats

Pos	Name/Nom
1	SCHIMANN Zoe, BC
2	TANAPIMA Langus, BC
3	PROCTOR Ava, AB

U12F Group 2

Competitors/Compétiteurs

#	Name/Nom	Club	1	2	3	4	W/G	Pts	Pos
1	LAURIE Jasmine	AB	XX				0	0	4
2	ROTH Alexis	AB	10	XX	5	10	3	25	1
3	ROSKEWICH Mila	BC	5		XX		1	5	3
4	GIESBRECHT Abigail	BC	10		10	XX	2	20	2

Matches/Matches

Match	White/Blanc			Blue/Bleu	Res/Rés	Tim/Tmp	Code
A-25	LAURIE Jasmine	1	2	ROTH Alexis	0 - 10	1:30	WIP
A-26	ROSKEWICH Mila	3	4	GIESBRECHT Abigail	0 - 10	2:00	IPO
A-37	LAURIE Jasmine	1	3	ROSKEWICH Mila	0 - 5	2:00	WAZ
A-38	ROTH Alexis	2	4	GIESBRECHT Abigail	10 - 0	2:00	IPO
A-49	LAURIE Jasmine	1	4	GIESBRECHT Abigail	0 - 10	1:39	WIP
A-50	ROTH Alexis	2	3	ROSKEWICH Mila	5 - 0	2:00	WAZ

Results/Résultats

Pos	Name/Nom
1	ROTH Alexis, AB
2	GIESBRECHT Abigail, BC
3	ROSKEWICH Mila, BC

U12F Group 3

Competitors/Compétiteurs

#	Name/Nom	Club	1	2	3	4	W/G	Pts	Pos
1	TREMBLAY Maizey	AB	XX				0	0	4
2	CHEUNG Kamrynn	AB	10	XX			1	10	3
3	SQUAREK Brooklyn	AB	10	10	XX	10	3	30	1
4	MACLEAN Stella	AB	10	10		XX	2	20	2

Matches/Matches

Match	White/Blanc			Blue/Bleu	Res/Rés	Tim/Tmp	Code
B-28	TREMBLAY Maizey	1	2	CHEUNG Kamrynn	0 - 10	0:00	IPO
B-29	SQUAREK Brooklyn	3	4	MACLEAN Stella	10 - 0	0:00	IPO
B-40	TREMBLAY Maizey	1	3	SQUAREK Brooklyn	0 - 10	0:00	FUS
B-41	CHEUNG Kamrynn	2	4	MACLEAN Stella	0 - 10	0:06	IPO
B-52	TREMBLAY Maizey	1	4	MACLEAN Stella	0 - 10	0:00	FUS
B-53	CHEUNG Kamrynn	2	3	SQUAREK Brooklyn	0 - 10	0:22	IPO

Results/Résultats

Pos	Name/Nom
1	SQUAREK Brooklyn, AB
2	MACLEAN Stella, AB
3	CHEUNG Kamrynn, AB

U12F Group 4

Competitors/Compétiteurs

#	Name/Nom	Club	1	2	3	4	W/G	Pts	Pos
1	SOILAND Lexie	AB	XX	10	10	10	3	30	1
2	PERRON Carmen	AB		XX			0	0	4
3	BROOKE-COBBAERT Margaret	BC		10	XX	10	2	20	2
4	DENIE Greta	AB		5		XX	1	5	3

Matches/Matches

Match	White/Blanc			Blue/Bleu	Res/Rés	Tim/Tmp	Code
D-27	SOILAND Lexie	1	2	PERRON Carmen	10 - 0	1:11	WIP
D-28	BROOKE-COBBAERT Margaret	3	4	DENIE Greta	10 - 0	0:14	IPO
D-42	SOILAND Lexie	1	3	BROOKE-COBBAERT Margaret	10 - 0	1:16	IPO
D-43	PERRON Carmen	2	4	DENIE Greta	0 - 5	2:00	WAZ
D-57	SOILAND Lexie	1	4	DENIE Greta	10 - 0	2:00	IPO
D-58	PERRON Carmen	2	3	BROOKE-COBBAERT Margaret	0 - 10	1:34	IPO

Results/Résultats

Pos	Name/Nom
1	SOILAND Lexie, AB
2	BROOKE-COBBAERT Margaret, BC
3	DENIE Greta, AB

U12F Group 5

Competitors/Compétiteurs

#	Name/Nom	Club	1	2	3	4	W/G	Pts	Pos
1	BERNATCHEZ Kinsley	AB	XX	10	10	5	3	25	1
2	IVESON Sapphire	AB		XX	5	5	2	10	2
3	LEONARD Charlotte	SK			XX		0	0	4
4	WOOD Norah	AB			10	XX	1	10	3

Matches/Matches

Match	White/Blanc		Blue/Bleu	Res/Rés	Tim/Tmp	Code	
C-27	BERNATCHEZ Kinsley	1	2	IVESON Sapphire	10 - 0	0:34	IPO
C-28	LEONARD Charlotte	3	4	WOOD Norah	0 - 10	2:00	IPO
C-42	BERNATCHEZ Kinsley	1	3	LEONARD Charlotte	10 - 0	1:12	IPO
C-43	IVESON Sapphire	2	4	WOOD Norah	5 - 0	2:00	WAZ
C-57	BERNATCHEZ Kinsley	1	4	WOOD Norah	5 - 0	2:00	WAZ
C-58	IVESON Sapphire	2	3	LEONARD Charlotte	5 - 0	2:00	WAZ

Results/Résultats

Pos	Name/Nom
1	BERNATCHEZ Kinsley, AB
2	IVESON Sapphire, AB
3	WOOD Norah, AB

U12F Group 6

Competitors/Compétiteurs

#	Name/Nom	Club	1	2	3	W/G	Pts	Pos
1	AU Natalie	BC	XX	10	10	2	20	1
2	CASSIDY Sophie	BC		XX		0	0	3
3	WOLOSHYN Kamryn	AB		10	XX	1	10	2

Matches/Matches

Match	White/Blanc			Blue/Bleu	Res/Rés	Tim/Tmp	Code
A-27	AU Natalie	1	2	CASSIDY Sophie	10 - 0	0:29	WIP
A-39	AU Natalie	1	3	WOLOSHYN Kamryn	10 - 0	0:39	IPO
A-51	CASSIDY Sophie	2	3	WOLOSHYN Kamryn	0 - 10	0:13	IPO

Results/Résultats

Pos	Name/Nom
1	AU Natalie, BC
2	WOLOSHYN Kamryn, AB

U12F Group 7

Competitors/Compétiteurs

#	Name/Nom	Club	1	2	3	4	W/G	Pts	Pos
1	AUSTMAN Emily	BC	XX				0	0	4
2	BECKETT Sasha	BC	5	XX		10	2	15	2
3	CORRIVEAU Lianna	YT	5	10	XX		2	15	1
4	ACRON Scarlett	AB	5		5	XX	2	10	3

Matches/Matches

Match	White/Blanc		Blue/Bleu	Res/Rés	Tim/Tmp	Code	
B-30	AUSTMAN Emily	1	2	BECKETT Sasha	0 - 5	2:00	WAZ
B-31	CORRIVEAU Lianna	3	4	ACRON Scarlett	0 - 5	2:00	WAZ
B-42	AUSTMAN Emily	1	3	CORRIVEAU Lianna	0 - 5	2:00	WAZ
B-43	BECKETT Sasha	2	4	ACRON Scarlett	10 - 0	2:00	IPO
B-54	AUSTMAN Emily	1	4	ACRON Scarlett	0 - 5	2:00	WAZ
B-55	BECKETT Sasha	2	3	CORRIVEAU Lianna	0 - 10	0:26	WIP

Results/Résultats

Pos	Name/Nom
1	CORRIVEAU Lianna, YT
2	BECKETT Sasha, BC
3	ACRON Scarlett, AB

U12F Group 8

Competitors/Compétiteurs

#	Name/Nom	Club	1	2	3	4	W/G	Pts	Pos
1	HALLIWELL Nora	AB	XX				0	0	4
2	CALVERT Miya	AB	10	XX			1	10	3
3	BLANCHETTE Daphne	BC	10	10	XX		2	20	2
4	STEIGER Claire	BC	10	10	10	XX	3	30	1

Matches/Matches

Match	White/Blanc			Blue/Bleu	Res/Rés	Tim/Tmp	Code
D-29	HALLIWELL Nora	1	2	CALVERT Miya	0 - 10	1:38	WIP
D-30	BLANCHETTE Daphne	3	4	STEIGER Claire	0 - 10	0:38	IPO
D-44	HALLIWELL Nora	1	3	BLANCHETTE Daphne	0 - 10	0:17	IPO
D-45	CALVERT Miya	2	4	STEIGER Claire	0 - 10	0:18	IPO
D-59	HALLIWELL Nora	1	4	STEIGER Claire	0 - 10	0:57	IPO
D-60	CALVERT Miya	2	3	BLANCHETTE Daphne	0 - 10	1:56	WIP

Results/Résultats

Pos	Name/Nom
1	STEIGER Claire, BC
2	BLANCHETTE Daphne, BC
3	CALVERT Miya, AB

U12F Group 9

Competitors/Compétiteurs

#	Name/Nom	Club	1	2	3	W/G	Pts	Pos
1	SHTEREVA Lidiya	AB	XX	10		1	10	2
2	HOHL Lily-Ava	AB		XX		0	0	3
3	MORRIS Cadence	BC	10	10	XX	2	20	1

Matches/Matches

Match	White/Blanc			Blue/Bleu	Res/Rés	Tim/Tmp	Code
D-31	SHTEREVA Lidiya	1	2	HOHL Lily-Ava	10 - 0	1:20	WIP
D-46	SHTEREVA Lidiya	1	3	MORRIS Cadence	0 - 10	0:20	IPO
D-61	HOHL Lily-Ava	2	3	MORRIS Cadence	0 - 10	1:07	IPO

Results/Résultats

Pos	Name/Nom
1	MORRIS Cadence, BC
2	SHTEREVA Lidiya, AB

U12M Group 1

Competitors/Compétiteurs

#	Name/Nom	Club	1	2	3	4	W/G	Pts	Pos
1	LEMIRE Liam	AB	XX		5	10	2	15	3
2	SYER Shain Jr.	AB	10	XX		10	2	20	2
3	STEITZER Oliver	NT		10	XX	10	2	20	1
4	ROBB Titan	BC				XX	0	0	4

Matches/Matches

Match	White/Blanc			Blue/Bleu	Res/Rés	Tim/Tmp	Code
C-25	LEMIRE Liam	1	2	SYER Shain Jr.	0 - 10	2:00	IPO
C-26	STEITZER Oliver	3	4	ROBB Titan	10 - 0	1:58	WIP
C-40	LEMIRE Liam	1	3	STEITZER Oliver	5 - 0	2:00	WAZ
C-41	SYER Shain Jr.	2	4	ROBB Titan	10 - 0	0:21	WIP
C-55	LEMIRE Liam	1	4	ROBB Titan	10 - 0	0:17	IPO
C-56	SYER Shain Jr.	2	3	STEITZER Oliver	0 - 10	1:35	IPO

Results/Résultats

Pos	Name/Nom
1	STEITZER Oliver, NT
2	SYER Shain Jr., AB
3	LEMIRE Liam, AB

U12M Group 2

Competitors/Compétiteurs

#	Name/Nom	Club	1	2	3	4	W/G	Pts	Pos
1	WILCZEK Eric	AB	XX	5	10	10	3	25	1
2	PENNER Asher	AB		XX	10		1	10	3
3	KURJATA Beckett	BC			XX		0	0	4
4	MUSTAFA Ibragimov	BC		10	10	XX	2	20	2

Matches/Matches

Match	White/Blanc			Blue/Bleu	Res/Rés	Tim/Tmp	Code
C-29	WILCZEK Eric	1	2	PENNER Asher	5 - 0	2:00	WAZ
C-30	KURJATA Beckett	3	4	MUSTAFA Ibragimov	0 - 10	0:35	IPO
C-44	WILCZEK Eric	1	3	KURJATA Beckett	10 - 0	1:08	IPO
C-45	PENNER Asher	2	4	MUSTAFA Ibragimov	0 - 10	2:00	IPO
C-59	WILCZEK Eric	1	4	MUSTAFA Ibragimov	10 - 0	0:14	IPO
C-60	PENNER Asher	2	3	KURJATA Beckett	10 - 0	1:04	IPO

Results/Résultats

Pos	Name/Nom
1	WILCZEK Eric, AB
2	MUSTAFA Ibragimov, BC
3	PENNER Asher, AB

U12M Group 3

Competitors/Compétiteurs

#	Name/Nom	Club	1	2	3	4	W/G	Pts	Pos
1	LORENCZ Corbin	AB	XX	5			1	5	3
2	HNATCHUK Myron	AB		XX	5		1	5	4
3	PARK Grayson	BC	10		XX		1	10	2
4	POLTORATSKIY Platon	ON	10	10	5	XX	3	25	1

Matches/Matches

Match	White/Blanc			Blue/Bleu	Res/Rés	Tim/Tmp	Code
A-28	LORENCZ Corbin	1	2	HNATCHUK Myron	5 - 0	2:00	WAZ
A-29	PARK Grayson	3	4	POLTORATSKIY Platon	0 - 5	2:00	WAZ
A-40	LORENCZ Corbin	1	3	PARK Grayson	0 - 10	1:16	WIP
A-41	HNATCHUK Myron	2	4	POLTORATSKIY Platon	0 - 10	2:00	IPO
A-52	LORENCZ Corbin	1	4	POLTORATSKIY Platon	0 - 10	0:46	IPO
A-53	HNATCHUK Myron	2	3	PARK Grayson	5 - 0	2:00	WAZ

Results/Résultats

Pos	Name/Nom
1	POLTORATSKIY Platon, ON
2	PARK Grayson, BC
3	LORENCZ Corbin, AB
4	HNATCHUK Myron, AB

U12M Group 4

Competitors/Compétiteurs

#	Name/Nom	Club	1	2	3	4	W/G	Pts	Pos
1	MARAGH Marcus	AB	XX		10		1	10	3
2	OTTOWICZ Slymon	AB	10	XX	10	10	3	30	1
3	MEJERY Alexey	ON			XX		0	0	4
4	PRATSCHKE Charlie	BC	10		10	XX	2	20	2

Matches/Matches

Match	White/Blanc			Blue/Bleu	Res/Rés	Tim/Tmp	Code
B-32	MARAGH Marcus	1	2	OTTOWICZ Slymon	0 - 10	0:39	WIP
B-33	MEJERY Alexey	3	4	PRATSCHKE Charlie	0 - 10	0:00	FUS
B-44	MARAGH Marcus	1	3	MEJERY Alexey	10 - 0	0:00	FUS
B-45	OTTOWICZ Slymon	2	4	PRATSCHKE Charlie	10 - 0	0:37	IPO
B-56	MARAGH Marcus	1	4	PRATSCHKE Charlie	0 - 10	1:21	WIP
B-57	OTTOWICZ Slymon	2	3	MEJERY Alexey	10 - 0	0:00	FUS

Results/Résultats

Pos	Name/Nom
1	OTTOWICZ Slymon, AB
2	PRATSCHKE Charlie, BC
3	MARAGH Marcus, AB

U12M Group 5

Competitors/Compétiteurs

#	Name/Nom	Club	1	2	3	4	W/G	Pts	Pos
1	MUSIIENKO Mykyta	AB	XX		10	10	2	20	2
2	DEMAERE Lucas	AB	5	XX	10	10	3	25	1
3	BRIGGS Kippen	YT			XX		0	0	4
4	TATLOW Jackson	SK			5	XX	1	5	3

Matches/Matches

Match	White/Blanc			Blue/Bleu	Res/Rés	Tim/Tmp	Code
D-32	MUSIIENKO Mykyta	1	2	DEMAERE Lucas	0 - 5	2:00	WAZ
D-33	BRIGGS Kippen	3	4	TATLOW Jackson	0 - 5	2:00	WAZ
D-47	MUSIIENKO Mykyta	1	3	BRIGGS Kippen	10 - 0	0:32	IPO
D-48	DEMAERE Lucas	2	4	TATLOW Jackson	10 - 0	0:29	WIP
D-62	MUSIIENKO Mykyta	1	4	TATLOW Jackson	10 - 0	1:58	IPO
D-63	DEMAERE Lucas	2	3	BRIGGS Kippen	10 - 0	0:29	WIP

Results/Résultats

Pos	Name/Nom
1	DEMAERE Lucas, AB
2	MUSIIENKO Mykyta, AB
3	TATLOW Jackson, SK

U12M Group 6

Competitors/Compétiteurs

#	Name/Nom	Club	1	2	3	4	W/G	Pts	Pos
1	KOVALIVSKI Danylo	AB	XX	10	10		2	20	2
2	BOESE Clark	AB		XX	10		1	10	3
3	PROCTOR Kole	BC			XX		0	0	4
4	VERBITSKY Victor	AB	10	10	10	XX	3	30	1

Matches/Matches

Match	White/Blanc			Blue/Bleu	Res/Rés	Tim/Tmp	Code
C-31	KOVALIVSKI Danylo	1	2	BOESE Clark	10 - 0	0:40	WIP
C-32	PROCTOR Kole	3	4	VERBITSKY Victor	0 - 10	1:17	IPO
C-46	KOVALIVSKI Danylo	1	3	PROCTOR Kole	10 - 0	1:00	WIP
C-47	BOESE Clark	2	4	VERBITSKY Victor	0 - 10	0:44	IPO
C-61	KOVALIVSKI Danylo	1	4	VERBITSKY Victor	0 - 10	2:00	IPO
C-62	BOESE Clark	2	3	PROCTOR Kole	10 - 0	1:08	IPO

Results/Résultats

Pos	Name/Nom
1	VERBITSKY Victor, AB
2	KOVALIVSKI Danylo, AB
3	BOESE Clark, AB

U12M Group 7

Competitors/Compétiteurs

#	Name/Nom	Club	1	2	3	4	W/G	Pts	Pos
1	SQUAREK Jace	AB	XX	5	10	5	3	20	1
2	SHERK Canyon	AB		XX	10		1	10	3
3	BROWN Connor	AB			XX		0	0	4
4	KLIPPENSTINE Wyatt	AB		10	10	XX	2	20	2

Matches/Matches

Match	White/Blanc	Blue/Bleu	Res/Rés	Tim/Tmp	Code
A-30	SQUAREK Jace 1 2	SHERK Canyon	5 - 0	2:00	WAZ
A-31	BROWN Connor 3 4	KLIPPENSTINE Wyatt	0 - 10	0:30	IPO
A-42	SQUAREK Jace 1 3	BROWN Connor	10 - 0	0:25	WIP
A-43	SHERK Canyon 2 4	KLIPPENSTINE Wyatt	0 - 10	2:00	IPO
A-54	SQUAREK Jace 1 4	KLIPPENSTINE Wyatt	5 - 0	2:00	WAZ
A-55	SHERK Canyon 2 3	BROWN Connor	10 - 0	1:21	IPO

Results/Résultats

Pos	Name/Nom
1	SQUAREK Jace, AB
2	KLIPPENSTINE Wyatt, AB
3	SHERK Canyon, AB

U12M Group 8

Competitors/Compétiteurs

#	Name/Nom	Club	1	2	3	4	W/G	Pts	Pos
1	TARASENKO Maksym	AB	XX		5	10	2	15	2
2	MUSIIENKO Mikhailo	AB	10	XX	10	10	3	30	1
3	HENRY Julian	BC			XX	10	1	10	3
4	DORNSTAUDER Jonah	SK				XX	0	0	4

Matches/Matches

Match	White/Blanc		Blue/Bleu	Res/Rés	Tim/Tmp	Code	
B-34	TARASENKO Maksym	1	2	MUSIIENKO Mikhailo	0 - 10	0:41	WIP
B-35	HENRY Julian	3	4	DORNSTAUDER Jonah	10 - 0	0:52	IPO
B-46	TARASENKO Maksym	1	3	HENRY Julian	5 - 0	2:00	WAZ
B-47	MUSIIENKO Mikhailo	2	4	DORNSTAUDER Jonah	10 - 0	0:09	IPO
B-58	TARASENKO Maksym	1	4	DORNSTAUDER Jonah	10 - 0	0:26	WIP
B-59	MUSIIENKO Mikhailo	2	3	HENRY Julian	10 - 0	1:43	IPO

Results/Résultats

Pos	Name/Nom
1	MUSIIENKO Mikhailo, AB
2	TARASENKO Maksym, AB
3	HENRY Julian, BC

U12M Group 9

Competitors/Compétiteurs

#	Name/Nom	Club	1	2	3	4	W/G	Pts	Pos
1	KHNYKIN Demid	AB	XX		10		1	10	3
2	NISH Isaac	AB	10	XX	10	5	3	25	1
3	MCLEOD Zack	BC			XX		0	0	4
4	VARVARICI Artiom	AB	10		10	XX	2	20	2

Matches/Matches

Match	White/Blanc			Blue/Bleu	Res/Rés	Tim/Tmp	Code
D-34	KHNYKIN Demid	1	2	NISH Isaac	0 - 10	2:00	IPO
D-35	MCLEOD Zack	3	4	VARVARICI Artiom	0 - 10	0:55	WIP
D-49	KHNYKIN Demid	1	3	MCLEOD Zack	10 - 0	0:15	WIP
D-50	NISH Isaac	2	4	VARVARICI Artiom	5 - 0	2:00	WAZ
D-64	KHNYKIN Demid	1	4	VARVARICI Artiom	0 - 10	2:00	IPO
D-65	NISH Isaac	2	3	MCLEOD Zack	10 - 0	0:46	IPO

Results/Résultats

Pos	Name/Nom
1	NISH Isaac, AB
2	VARVARICI Artiom, AB
3	KHNYKIN Demid, AB

U12M Group 10

Competitors/Compétiteurs

#	Name/Nom	Club	1	2	3	4	W/G	Pts	Pos
1	MATTRWD Yannal	AB	XX			10	1	10	2
2	MARTIN Dextin	AB	10	XX			1	10	4
3	HALKTIONOV Misha	SK	10	10	XX	10	3	30	1
4	PARDY Nolan	AB		10		XX	1	10	3

Matches/Matches

Match	White/Blanc			Blue/Bleu	Res/Rés	Tim/Tmp	Code
C-33	MATTRWD Yannal	1	2	MARTIN Dextin	0 - 10	2:00	IPO
C-34	HALKTIONOV Misha	3	4	PARDY Nolan	10 - 0	0:27	WIP
C-48	MATTRWD Yannal	1	3	HALKTIONOV Misha	0 - 10	0:08	IPO
C-49	MARTIN Dextin	2	4	PARDY Nolan	0 - 10	2:00	IPO
C-63	MATTRWD Yannal	1	4	PARDY Nolan	10 - 0	0:48	IPO
C-64	MARTIN Dextin	2	3	HALKTIONOV Misha	0 - 10	0:13	IPO

Results/Résultats

Pos	Name/Nom
1	HALKTIONOV Misha, SK
2	MATTRWD Yannal, AB
2	PARDY Nolan, AB
2	MARTIN Dextin, AB

U12M Group 11

Competitors/Compétiteurs

#	Name/Nom	Club	1	2	3	4	W/G	Pts	Pos
1	HEBER Lorenzo	AB	XX	5	10		2	15	2
2	PASCAN Sebastian	AB		XX	10		1	10	3
3	FROST Nathan	BC			XX		0	0	4
4	MCALPINE Brolan	AB	10	10	10	XX	3	30	1

Matches/Matches

Match	White/Blanc		Blue/Bleu	Res/Rés	Tim/Tmp	Code	
A-32	HEBER Lorenzo	1	2	PASCAN Sebastian	5 - 0	2:00	WAZ
A-33	FROST Nathan	3	4	MCALPINE Brolan	0 - 10	1:02	WIP
A-44	HEBER Lorenzo	1	3	FROST Nathan	10 - 0	0:34	WIP
A-45	PASCAN Sebastian	2	4	MCALPINE Brolan	0 - 10	1:52	WIP
A-56	HEBER Lorenzo	1	4	MCALPINE Brolan	0 - 10	1:57	IPO
A-57	PASCAN Sebastian	2	3	FROST Nathan	10 - 0	0:47	WIP

Results/Résultats

Pos	Name/Nom
1	MCALPINE Brolan, AB
2	HEBER Lorenzo, AB
3	PASCAN Sebastian, AB

U12M Group 12

Competitors/Compétiteurs

#	Name/Nom	Club	1	2	3	4	W/G	Pts	Pos
1	CROUCHER Max	AB	XX				0	0	4
2	RATCLIFFE Brogan	AB	5	XX			1	5	3
3	TAKAHASHI Huxley	AB	10	10	XX		2	20	2
4	KHORTIV Andrii	AB	10	10	10	XX	3	30	1

Matches/Matches

Match	White/Blanc			Blue/Bleu	Res/Rés	Tim/Tmp	Code
B-36	CROUCHER Max	1	2	RATCLIFFE Brogan	0 - 5	2:00	WAZ
B-37	TAKAHASHI Huxley	3	4	KHORTIV Andrii	0 - 10	1:46	IPO
B-48	CROUCHER Max	1	3	TAKAHASHI Huxley	0 - 10	0:26	WIP
B-49	RATCLIFFE Brogan	2	4	KHORTIV Andrii	0 - 10	0:28	WIP
B-60	CROUCHER Max	1	4	KHORTIV Andrii	0 - 10	0:39	IPO
B-61	RATCLIFFE Brogan	2	3	TAKAHASHI Huxley	0 - 10	1:52	WIP

Results/Résultats

Pos	Name/Nom
1	KHORTIV Andrii, AB
2	TAKAHASHI Huxley, AB
3	RATCLIFFE Brogan, AB

U12M Group 13

Competitors/Compétiteurs

#	Name/Nom	Club	1	2	3	4	W/G	Pts	Pos
1	WALTON Justin	AB	XX	10	10	10	3	30	1
2	SOKOLOV Andrey	AB		XX		10	1	10	3
3	ALIZADA David	AB		10	XX	5	2	15	2
4	CLINE Malone	AB				XX	0	0	4

Matches/Matches

Match	White/Blanc		Blue/Bleu	Res/Rés	Tim/Tmp	Code	
D-36	WALTON Justin	1	2	SOKOLOV Andrey	10 - 0	2:00	WIP
D-37	ALIZADA David	3	4	CLINE Malone	5 - 0	2:00	WAZ
D-51	WALTON Justin	1	3	ALIZADA David	10 - 0	1:05	IPO
D-52	SOKOLOV Andrey	2	4	CLINE Malone	10 - 0	1:50	WIP
D-66	WALTON Justin	1	4	CLINE Malone	10 - 0	1:35	WIP
D-67	SOKOLOV Andrey	2	3	ALIZADA David	0 - 10	2:00	IPO

Results/Résultats

Pos	Name/Nom
1	WALTON Justin, AB
2	ALIZADA David, AB
3	SOKOLOV Andrey, AB

U12M Group 14

Competitors/Compétiteurs

#	Name/Nom	Club	1	2	3	4	W/G	Pts	Pos
1	BORAS Brandon	AB	XX	10	10	10	3	30	1
2	JEFFERY Elliot	AB		XX	10	10	2	20	2
3	BEATON Lucian	BC			XX		0	0	4
4	PARCHOMCHUK Reid	BC			10	XX	1	10	3

Matches/Matches

Match	White/Blanc		Blue/Bleu	Res/Rés	Tim/Tmp	Code	
C-35	BORAS Brandon	1	2	JEFFERY Elliot	10 - 0	1:37	WIP
C-36	BEATON Lucian	3	4	PARCHOMCHUK Reid	0 - 10	0:39	IPO
C-50	BORAS Brandon	1	3	BEATON Lucian	10 - 0	0:09	IPO
C-51	JEFFERY Elliot	2	4	PARCHOMCHUK Reid	10 - 0	2:00	WIP
C-65	BORAS Brandon	1	4	PARCHOMCHUK Reid	10 - 0	0:08	IPO
C-66	JEFFERY Elliot	2	3	BEATON Lucian	10 - 0	1:38	WIP

Results/Résultats

Pos	Name/Nom
1	BORAS Brandon, AB
2	JEFFERY Elliot, AB
3	PARCHOMCHUK Reid, BC

U12M Group 15

Competitors/Compétiteurs

#	Name/Nom	Club	1	2	3	4	W/G	Pts	Pos
1	KOOISTRA Wyatt	AB	XX	10		10	2	20	1
2	MACHATTIE Dominic	AB		XX	10		1	10	3
3	BONNER Chase	BC	10		XX		1	10	4
4	ABBOTT Xander	BC		10	5	XX	2	15	2

Matches/Matches

Match	White/Blanc		Blue/Bleu	Res/Rés	Tim/Tmp	Code	
A-34	KOOISTRA Wyatt	1	2	MACHATTIE Dominic	10 - 0	1:23	IPO
A-35	BONNER Chase	3	4	ABBOTT Xander	0 - 5	2:00	WAZ
A-46	KOOISTRA Wyatt	1	3	BONNER Chase	0 - 10	1:03	WIP
A-47	MACHATTIE Dominic	2	4	ABBOTT Xander	0 - 10	0:36	WIP
A-58	KOOISTRA Wyatt	1	4	ABBOTT Xander	10 - 0	0:24	WIP
A-59	MACHATTIE Dominic	2	3	BONNER Chase	10 - 0	0:59	WIP

Results/Résultats

Pos	Name/Nom
1	KOOISTRA Wyatt, AB
2	ABBOTT Xander, BC
3	MACHATTIE Dominic, AB
4	BONNER Chase, BC

U12M Group 16

Competitors/Compétiteurs

#	Name/Nom	Club	1	2	3	4	W/G	Pts	Pos
1	STOBBE Jasper	AB	XX		10		1	10	3
2	BLAKE Bryce	AB	10	XX	5		2	15	2
3	JORDAN Cian	BC			XX		0	0	4
4	NASSIF Daniel	ON	10	10	10	XX	3	30	1

Matches/Matches

Match	White/Blanc			Blue/Bleu	Res/Rés	Tim/Tmp	Code
B-38	STOBBE Jasper	1	2	BLAKE Bryce	0 - 10	2:00	IPO
B-39	JORDAN Cian	3	4	NASSIF Daniel	0 - 10	1:10	WIP
B-50	STOBBE Jasper	1	3	JORDAN Cian	10 - 0	2:00	IPO
B-51	BLAKE Bryce	2	4	NASSIF Daniel	0 - 10	0:57	IPO
B-62	STOBBE Jasper	1	4	NASSIF Daniel	0 - 10	0:17	WIP
B-63	BLAKE Bryce	2	3	JORDAN Cian	5 - 0	2:00	WAZ

Results/Résultats

Pos	Name/Nom
1	NASSIF Daniel, ON
2	BLAKE Bryce, AB
3	STOBBE Jasper, AB

U12M Group 17

Competitors/Compétiteurs

#	Name/Nom	Club	1	2	3	4	W/G	Pts	Pos
1	CRYER Beau	BC	XX	10	10	10	3	30	1
2	SAENZ EMMERSON Mateo	BC		XX			0	0	4
3	BAYANJARGAL Tugs-Erdene	AB		10	XX		1	10	3
4	HUSSEIN Yassine	SK		10	10	XX	2	20	2

Matches/Matches

Match	White/Blanc			Blue/Bleu	Res/Rés	Tim/Tmp	Code
D-38	CRYER Beau	1	2	SAENZ EMMERSON Mateo	10 - 0	0:27	IPO
D-39	BAYANJARGAL Tugs-Erdene	3	4	HUSSEIN Yassine	0 - 10	0:08	IPO
D-53	CRYER Beau	1	3	BAYANJARGAL Tugs-Erdene	10 - 0	0:22	IPO
D-54	SAENZ EMMERSON Mateo	2	4	HUSSEIN Yassine	0 - 10	0:17	IPO
D-68	CRYER Beau	1	4	HUSSEIN Yassine	10 - 0	0:26	WIP
D-69	SAENZ EMMERSON Mateo	2	3	BAYANJARGAL Tugs-Erdene	0 - 10	0:00	FUS

Results/Résultats

Pos	Name/Nom
1	CRYER Beau, BC
2	HUSSEIN Yassine, SK
3	BAYANJARGAL Tugs-Erdene, AB

U12M Group 18

Competitors/Compétiteurs

#	Name/Nom	Club	1	2	3	4	W/G	Pts	Pos
1	ADDALI Wesam	AB	XX	10		10	2	20	2
2	NIELSEN Bryce	AB		XX			0	0	4
3	VIEAUX Silas	BC	10	10	XX	10	3	30	1
4	MARINHO Alexander	BC		10		XX	1	10	3

Matches/Matches

Match	White/Blanc		Blue/Bleu	Res/Rés	Tim/Tmp	Code	
C-37	ADDALI Wesam	1	2	NIELSEN Bryce	10 - 0	2:00	IPO
C-38	VIEAUX Silas	3	4	MARINHO Alexander	10 - 0	0:16	IPO
C-52	ADDALI Wesam	1	3	VIEAUX Silas	0 - 10	0:00	WIP
C-53	NIELSEN Bryce	2	4	MARINHO Alexander	0 - 10	1:28	WIP
C-67	ADDALI Wesam	1	4	MARINHO Alexander	10 - 0	1:04	IPO
C-68	NIELSEN Bryce	2	3	VIEAUX Silas	0 - 10	1:00	IPO

Results/Résultats

Pos	Name/Nom
1	VIEAUX Silas, BC
2	ADDALI Wesam, AB
3	MARINHO Alexander, BC

U12M Group 19

Competitors/Compétiteurs

#	Name/Nom	Club	1	2	3	W/G	Pts	Pos
1	MAY Connor	AB	XX	10	5	2	15	1
2	WEISE Emerest	AB		XX		0	0	3
3	SPRINKLE Axel	BC		10	XX	1	10	2

Matches/Matches

Match	White/Blanc			Blue/Bleu	Res/Rés	Tim/Tmp	Code
C-39	MAY Connor	1	2	WEISE Emerest	10 - 0	2:00	IPO
C-54	MAY Connor	1	3	SPRINKLE Axel	5 - 0	2:00	WAZ
C-69	WEISE Emerest	2	3	SPRINKLE Axel	0 - 10	2:00	IPO

Results/Résultats

Pos	Name/Nom
1	MAY Connor, AB
2	SPRINKLE Axel, BC

U12M Group 20

Competitors/Compétiteurs

#	Name/Nom	Club	1	2	3	W/G	Pts	Pos
1	ZOOK Mya	AB	XX			0	0	3
2	KIRIAK Eli	YT	10	XX	10	2	20	1
3	BEKAURI Luka	ON	10		XX	1	10	2

Matches/Matches

Match	White/Blanc			Blue/Bleu	Res/Rés	Tim/Tmp	Code
A-36	ZOOK Mya	1	2	KIRIAK Eli	0 - 10	2:00	IPO
A-48	ZOOK Mya	1	3	BEKAURI Luka	0 - 10	1:01	WIP
A-60	KIRIAK Eli	2	3	BEKAURI Luka	10 - 0	0:47	IPO

Results/Résultats

Pos	Name/Nom
1	KIRIAK Eli, YT
2	BEKAURI Luka, ON

U14F -30 kg

Competitors/Compétiteurs

#	Name/Nom	Club	1	2	1	2	1	2	W/G	Pts	Pos
1	DEMAERE Miya	AB	XX	10	XX	10	XX		2	20	1
2	SCHIMANN Sylvie	BC		XX		XX		XX	0	0	2

Matches/Matches

Match	White/Blanc			Blue/Bleu	Res/Rés	Tim/Tmp	Code
D-116	DEMAERE Miya	1	2	SCHIMANN Sylvie	10 - 0	0:46	IPO
D-129	SCHIMANN Sylvie	2	1	DEMAERE Miya	0 - 10	2:22	IPO
D-141	DEMAERE Miya	1	2	SCHIMANN Sylvie			

Results/Résultats

Pos	Name/Nom
1	DEMAERE Miya, AB

U14F -33 kg

Competitors/Compétiteurs

#	Name/Nom	Club	1	2	3	4	W/G	Pts	Pos
1	SYER Rylee	AB	XX		5	10	2	15	2
2	TKACH Galaxy	AB	5	XX	10	10	3	25	1
3	KO Sarah	BC			XX	10	1	10	3
4	ZOTZMAN Sierra	AB				XX	0	0	4

Matches/Matches

Match	White/Blanc			Blue/Bleu	Res/Rés	Tim/Tmp	Code
A-101	SYER Rylee	1	2	TKACH Galaxy	0 - 5	3:00	WAZ
A-102	KO Sarah	3	4	ZOTZMAN Sierra	10 - 0	3:00	IPO
A-112	SYER Rylee	1	3	KO Sarah	5 - 0	3:00	WAZ
A-113	TKACH Galaxy	2	4	ZOTZMAN Sierra	10 - 0	0:13	IPO
A-121	SYER Rylee	1	4	ZOTZMAN Sierra	10 - 0	0:00	FUS
A-122	TKACH Galaxy	2	3	KO Sarah	10 - 0	0:53	IPO

Results/Résultats

Pos	Name/Nom
1	TKACH Galaxy, AB
2	SYER Rylee, AB
3	KO Sarah, BC

U14F -36 kg

Competitors/Compétiteurs A

#	Name/Nom	Club	1	2	3	W/G	Pts	Pos
1	BISHOP Halo	BC	XX		10	1	10	2
2	PROTASIWICH Mataija	AB	10	XX	10	2	20	1
3	KINLEY Eileigh	AB			XX	0	0	3

Pool A

Match	White/Blanc	Blue/Bleu	Res/Rés	Tim/Tmp	Code
C-95	BISHOP Halo 1 2	PROTASIWICH Mataija	0 - 10	0:00	FUS
C-106	BISHOP Halo 1 3	KINLEY Eileigh	10 - 0	1:45	WIP
C-115	PROTASIWICH Mataija 2 3	KINLEY Eileigh	10 - 0	1:04	WIP

Competitors/Compétiteurs B

#	Name/Nom	Club	4	5	6	W/G	Pts	Pos
4	BOESE Kate	AB	XX			0	0	3
5	SEEMAN Brooklyn	AB	10	XX	10	2	20	1
6	PARK Harper	BC	10		XX	1	10	2

Pool B

Match	White/Blanc	Blue/Bleu	Res/Rés	Tim/Tmp	Code
C-96	BOESE Kate 4 5	SEEMAN Brooklyn	0 - 10	0:40	WIP
C-107	BOESE Kate 4 6	PARK Harper	0 - 10	3:00	IPO
C-116	SEEMAN Brooklyn 5 6	PARK Harper	10 - 0	0:25	IPO

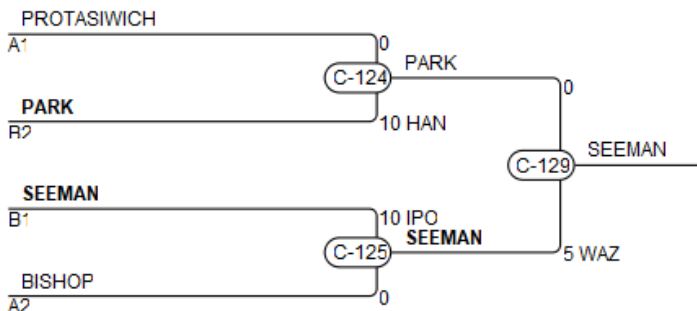

Results/Résultats

Pos	Name/Nom
1	SEEMAN Brooklyn, AB
2	PARK Harper, BC
3	PROTASIWICH Mataija, AB
3	BISHOP Halo, BC

U14F -40 kg

Competitors/Compétiteurs

#	Name/Nom	Club	1	2	3	W/G	Pts	Pos
1	PANAITESCU Alexandra	AB	XX	5		1	5	2
2	MOHAN Emma	AB		XX		0	0	3
3	COVASER Vanessa	BC	10	10	XX	2	20	1

Matches/Matches

Match	White/Blanc			Blue/Bleu	Res/Rés	Tim/Tmp	Code
B-103	PANAITESCU Alexandra	1	2	MOHAN Emma	5 - 0	3:00	WAZ
B-112	PANAITESCU Alexandra	1	3	COVASER Vanessa	0 - 10	0:27	IPO
B-119	MOHAN Emma	2	3	COVASER Vanessa	0 - 10	0:39	IPO

Results/Résultats

Pos	Name/Nom
1	COVASER Vanessa, BC
2	PANAITESCU Alexandra, AB

U14F -44 kg

Competitors/Compétiteurs

#	Name/Nom	Club	1	2	3	4	W/G	Pts	Pos
1	XU Grace	BC	XX				0	0	4
2	AU Megan	BC	5	XX	10	10	3	25	1
3	TORRANCE Lexi	AB	10		XX		1	10	3
4	SANDOVAL Kaitlyn	BC	10		10	XX	2	20	2

Matches/Matches

Match	White/Blanc			Blue/Bleu	Res/Rés	Tim/Tmp	Code
A-95	XU Grace	1	2	AU Megan	0 - 5	3:00	WAZ
A-96	TORRANCE Lexi	3	4	SANDOVAL Kaitlyn	0 - 10	2:47	IPO
A-107	XU Grace	1	3	TORRANCE Lexi	0 - 10	1:07	IPO
A-108	AU Megan	2	4	SANDOVAL Kaitlyn	10 - 0	1:00	WIP
A-116	XU Grace	1	4	SANDOVAL Kaitlyn	0 - 10	1:56	WIP
A-117	AU Megan	2	3	TORRANCE Lexi	10 - 0	0:46	WIP

Results/Résultats

Pos	Name/Nom
1	AU Megan, BC
2	SANDOVAL Kaitlyn, BC
3	TORRANCE Lexi, AB

U14F -48 kg

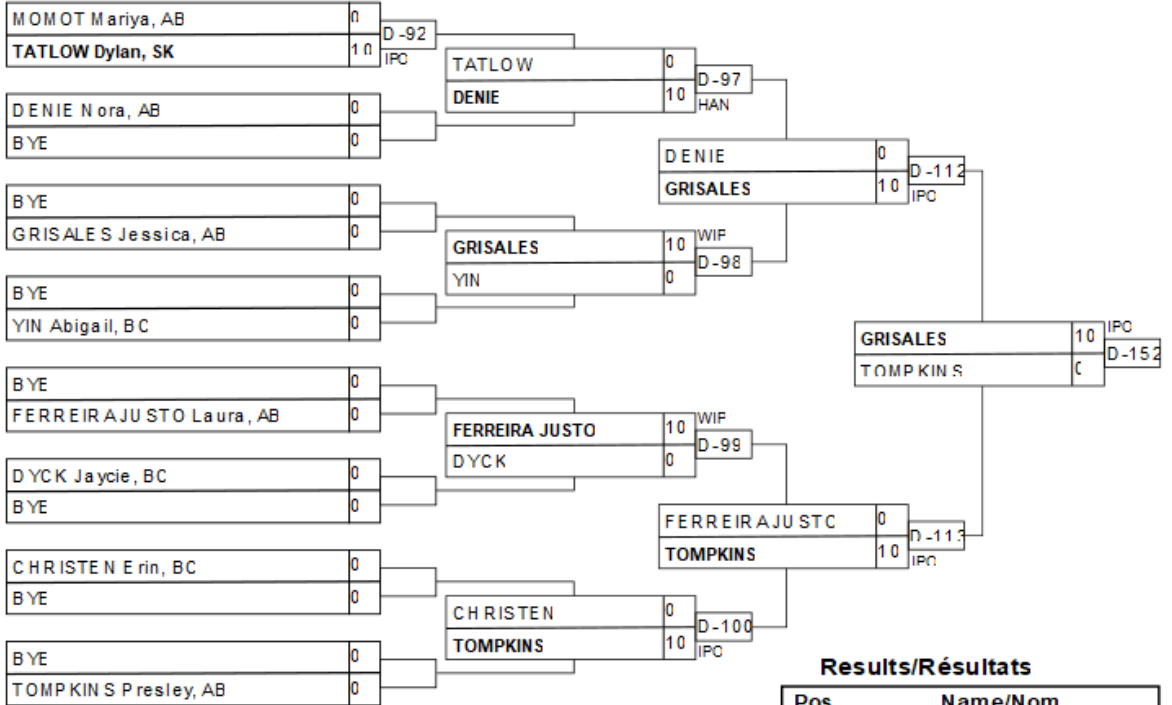

Results/Résultats

Pos	Name/Nom
1	GRISALES Jessica, AB
2	TOMPKINS Presley, AB
3	DENIE Nora, AB
3	FERREIRA JUSTO Laura, AB

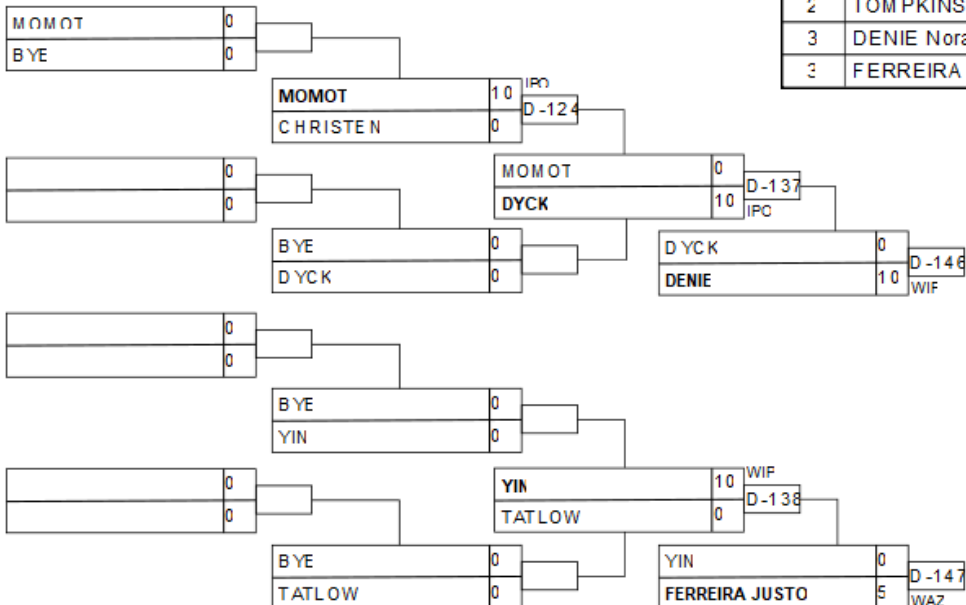

U14F -52 kg

Competitors/Compétiteurs

#	Name/Nom	Club	1	2	3	4	W/G	Pts	Pos
1	JOHAL Cooper	AB	XX				0	0	4
2	KOOISTRA Peyton	AB	10	XX		10	2	20	2
3	MORRISON Eilidh	AB	10	10	XX	10	3	30	1
4	CALVERT Yumi	AB	10			XX	1	10	3

Matches/Matches

Match	White/Blanc			Blue/Bleu	Res/Rés	Tim/Tmp	Code
B-101	JOHAL Cooper	1	2	KOOISTRA Peyton	0 - 10	0:19	WIP
B-102	MORRISON Eilidh	3	4	CALVERT Yumi	10 - 0	1:31	IPO
B-110	JOHAL Cooper	1	3	MORRISON Eilidh	0 - 10	0:18	IPO
B-111	KOOISTRA Peyton	2	4	CALVERT Yumi	10 - 0	0:22	WIP
B-117	JOHAL Cooper	1	4	CALVERT Yumi	0 - 10	1:02	WIP
B-118	KOOISTRA Peyton	2	3	MORRISON Eilidh	0 - 10	1:16	IPO

Results/Résultats

Pos	Name/Nom
1	MORRISON Eilidh, AB
2	KOOISTRA Peyton, AB
3	CALVERT Yumi, AB

U14F -63 kg

Competitors/Compétiteurs

#	Name/Nom	Club	1	2	3	4	W/G	Pts	Pos
1	SUMMERS Victoria	ON	XX	10	10	10	3	30	1
2	DORNSTAUDER Anna	SK		XX	10	10	2	20	2
3	AJIBADE Queen	NT			XX		0	0	4
4	PUSHKIN Aurora	BC			10	XX	1	10	3

Matches/Matches

Match	White/Blanc			Blue/Bleu	Res/Rés	Tim/Tmp	Code
C-99	SUMMERS Victoria	1	2	DORNSTAUDER Anna	10 - 0	0:32	IPO
C-100	AJIBADE Queen	3	4	PUSHKIN Aurora	0 - 10	0:50	WIP
C-110	SUMMERS Victoria	1	3	AJIBADE Queen	10 - 0	1:29	IPO
C-111	DORNSTAUDER Anna	2	4	PUSHKIN Aurora	10 - 0	3:00	IPO
C-119	SUMMERS Victoria	1	4	PUSHKIN Aurora	10 - 0	1:44	WIP
C-120	DORNSTAUDER Anna	2	3	AJIBADE Queen	10 - 0	1:42	WIP

Results/Résultats

Pos	Name/Nom
1	SUMMERS Victoria, ON
2	DORNSTAUDER Anna, SK
3	PUSHKIN Aurora, BC

U14F +63 kg

Competitors/Compétiteurs A

#	Name/Nom	Club	1	2	3	W/G	Pts	Pos
1	DION Oryx	AB	XX	10	10	2	20	1
2	MCALLISTER Gemma	AB		XX		0	0	3
3	NOBILE Valentina	AB		10	XX	1	10	2

Pool A

Match	White/Blanc	Blue/Bleu	Res/Rés	Tim/Tmp	Code
B-97	DION Oryx 1 2	MCALLISTER Gemma	10 - 0	1:03	WIP
B-104	DION Oryx 1 3	NOBILE Valentina	10 - 0	0:35	IPO
B-113	MCALLISTER Gemma 2 3	NOBILE Valentina	0 - 10	0:07	IPO

Competitors/Compétiteurs B

#	Name/Nom	Club	4	5	6	W/G	Pts	Pos
4	BOURDON Jasmine	AB	XX			0	0	3
5	MAWSON Josie	SK	10	XX	10	2	20	1
6	MACDONALD Haley	AB	10		XX	1	10	2

Pool B

Match	White/Blanc	Blue/Bleu	Res/Rés	Tim/Tmp	Code
B-98	BOURDON Jasmine 4 5	MAWSON Josie	0 - 10	0:55	IPO
B-105	BOURDON Jasmine 4 6	MACDONALD Haley	0 - 10	1:26	IPO
B-114	MAWSON Josie 5 6	MACDONALD Haley	10 - 0	2:26	IPO

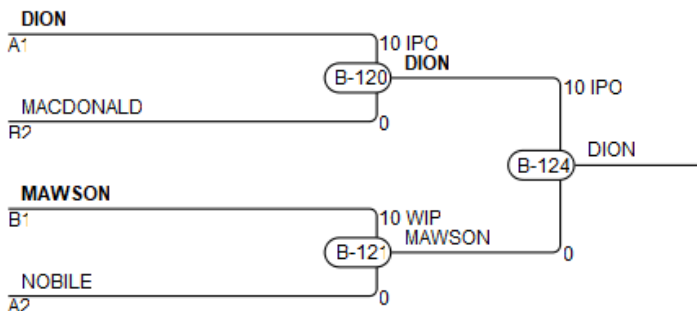

Results/Résultats

Pos	Name/Nom
1	DION Oryx, AB
2	MAWSON Josie, SK
3	MACDONALD Haley, AB
3	NOBILE Valentina, AB

U14M -32 kg

Competitors/Compétiteurs

#	Name/Nom	Club	1	2	3	4	W/G	Pts	Pos
1	CARAUS Dominik	AB	XX	10	10	10	3	30	1
2	HNATCHUK Vasyl	AB		XX	10	10	2	20	2
3	RUSHTON Wyatt	BC			XX	10	1	10	3
4	NEUFELD Toshi	AB				XX	0	0	4

Matches/Matches

Match	White/Blanc			Blue/Bleu	Res/Rés	Tim/Tmp	Code
D-110	CARAUS Dominik	1	2	HNATCHUK Vasyl	10 - 0	0:29	IPO
D-111	RUSHTON Wyatt	3	4	NEUFELD Toshi	10 - 0	3:00	IPO
D-122	CARAUS Dominik	1	3	RUSHTON Wyatt	10 - 0	0:14	IPO
D-123	HNATCHUK Vasyl	2	4	NEUFELD Toshi	10 - 0	3:00	IPO
D-135	CARAUS Dominik	1	4	NEUFELD Toshi	10 - 0	0:40	IPO
D-136	HNATCHUK Vasyl	2	3	RUSHTON Wyatt	10 - 0	0:44	IPO

Results/Résultats

Pos	Name/Nom
1	CARAUS Dominik, AB
2	HNATCHUK Vasyl, AB
3	RUSHTON Wyatt, BC

U14M -35 kg

Competitors/Compétiteurs A

#	Name/Nom	Club	1	2	3	4	W/G	Pts	Pos
1	KARAKUSHAN Victor	AB	XX				0	0	4
2	DOBSON Cooper	AB	5	XX			1	5	3
3	COLARUSSO Aurelio	QC	10	10	XX	10	3	30	1
4	HAZELL Graydon	AB	10	10		XX	2	20	2

Pool A

Match	White/Blanc	Blue/Bleu	Res/Rés	Tim/Tmp	Code
A-98	KARAKUSHAN Victor 1 2	DOBSON Cooper	0 - 5	3:00	WAZ
A-99	COLARUSSO Aurelio 3 4	HAZELL Graydon	10 - 0	0:17	IPO
A-109	KARAKUSHAN Victor 1 3	COLARUSSO Aurelio	0 - 10	0:12	IPO
A-110	DOBSON Cooper 2 4	HAZELL Graydon	0 - 10	1:03	IPO
A-118	KARAKUSHAN Victor 1 4	HAZELL Graydon	0 - 10	1:39	IPO
A-119	DOBSON Cooper 2 3	COLARUSSO Aurelio	0 - 10	0:31	IPO

Competitors/Compétiteurs B

#	Name/Nom	Club	5	6	7	W/G	Pts	Pos
5	TAMURA Grayson	AB	XX	10	10	2	20	1
6	UMANSKY Daniel	AB		XX		0	0	3
7	PARADIS Levi	AB		10	XX	1	10	2

Pool B

Match	White/Blanc	Blue/Bleu	Res/Rés	Tim/Tmp	Code
A-100	TAMURA Grayson 5 6	UMANSKY Daniel	10 - 0	0:23	IPO
A-111	TAMURA Grayson 5 7	PARADIS Levi	10 - 0	2:32	IPO
A-120	UMANSKY Daniel 6 7	PARADIS Levi	0 - 10	0:35	IPO

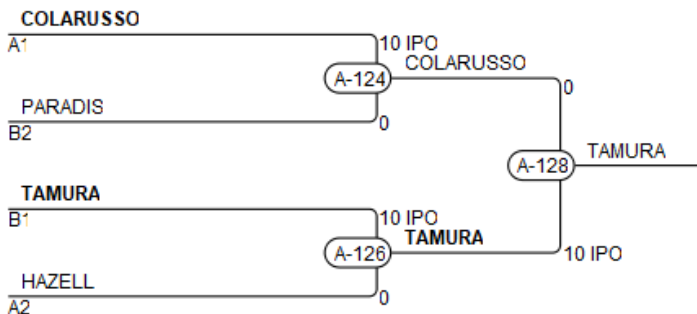

Results/Résultats

Pos	Name/Nom
1	TAMURA Grayson, AB
2	COLARUSSO Aurelio, QC
3	PARADIS Levi, AB
3	HAZELL Graydon, AB

U14M -38 kg

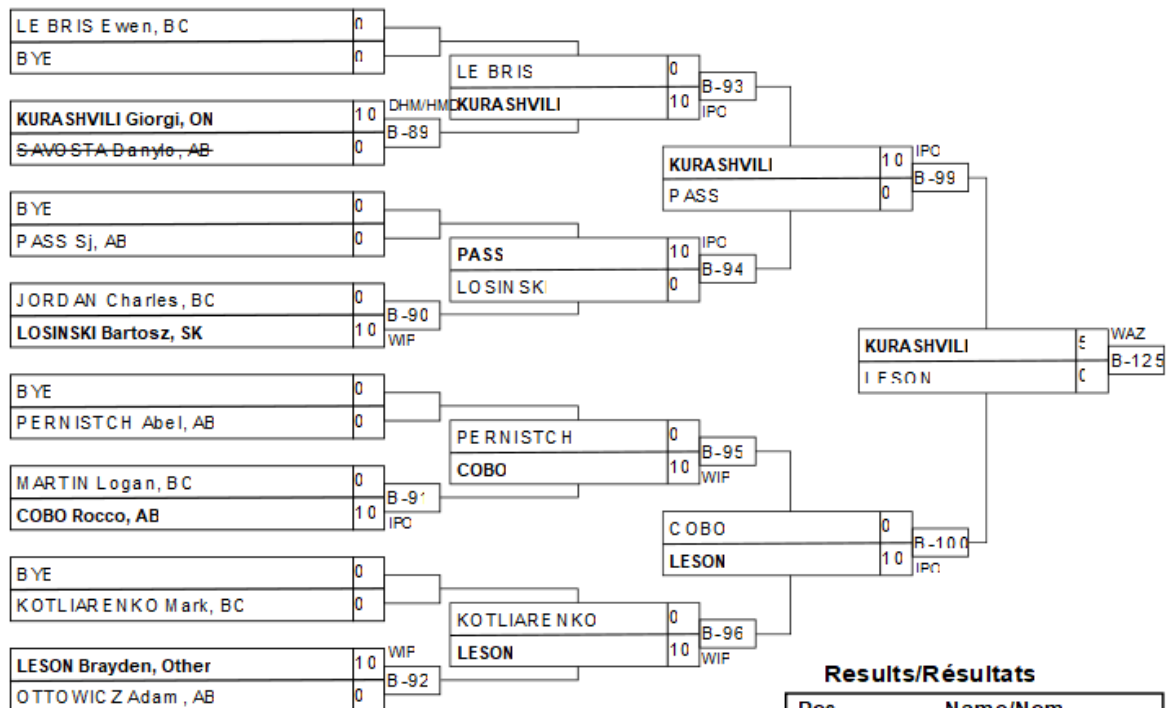

Results/Résultats

Pos	Name/Nom
1	KURASHVILI Giorgi, ON
2	LESON Bray den, Other
3	PASS Sj, AB
3	COBO Rocco, AB

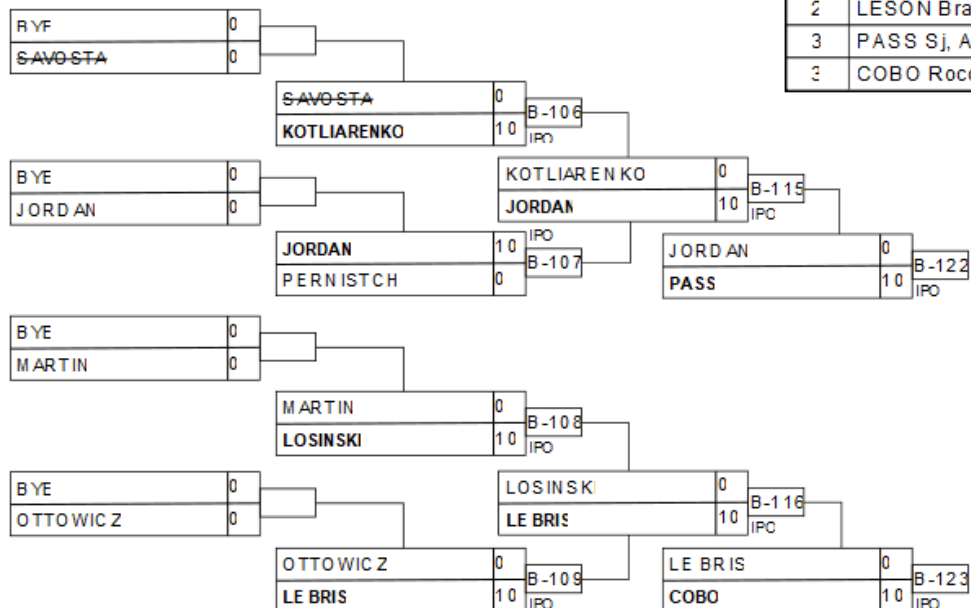

U14M -42 kg

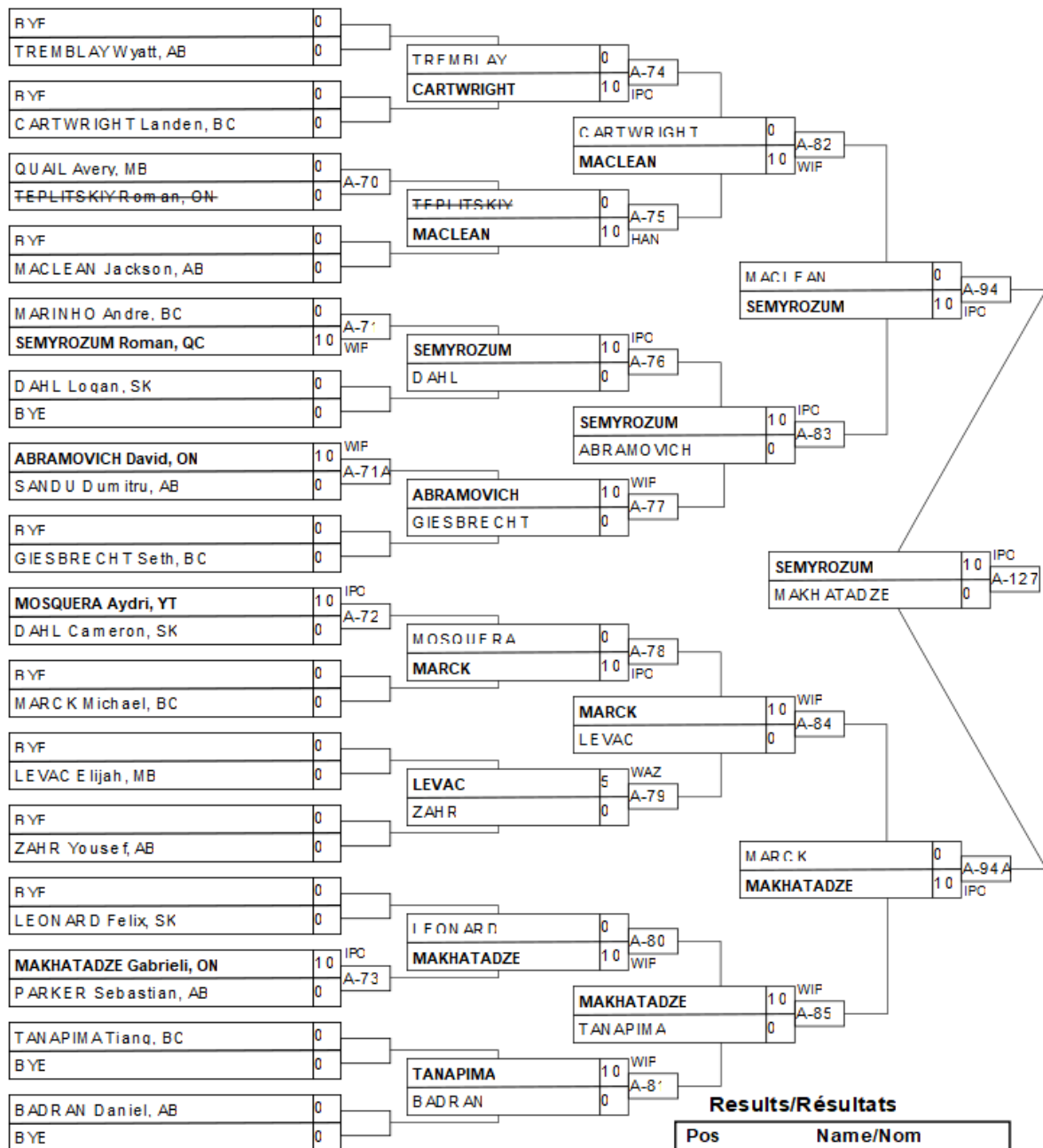

U14M -46 kg

CICATI Matvei, AB	0	C-79 IPC	KHILOV	10	IPC	C-85	KHILOV	10	IPC
KHILOV Maksim, ON	10			0	C-85			TANAKA SVERZUT	0
AUSTMAN Lucas, BC	0		AUSTMAN	0			KHILOV	10	IPC
BYE	0			0				TANAKA SVERZUT	0
TANAKA SVERZUT Fernando, BC	10	WF C-80	TANAKA SVERZUT	10	IPC	C-86	KHILOV	10	IPC
ROACH Drake, AB	0	0		LI	0			C-86	TANAKA SVERZUT
LI Yan Yin, AB	0		LI	0			KHILOV	10	IPC
BYE	0			0				LIFF-NFII MAN	0
BENNETT Shaye, AB	0	C-81 FUS	LEE-NEUMAN	10	IPC	C-87	LEE-NEUMAN	10	IPC
LEE-NEUMAN Emmett, SK	10			0	HOLLIDAY			0	C-87
BYE	0		LEE-NEUMAN	0			LEE-NEUMAN	10	IPC
HOLLIDAY Lyndon, BC	0			0				GRIGY	0
MAKOWICHUK Conor, BC	10	WF C-82	MAKOWICHUK	0		C-88	LEE-NEUMAN	10	IPC
SQUAREK Dustin, AB	0	0		GRIGY				5	WAZ
BYE	0		MAKOWICHUK	0		C-88	LEE-NEUMAN	10	IPC
GRIGY Donovan, AB	0			0				GRIGY	5

Results/Résultats

Pos	Name/Nom
1	KHILOV Maksim, ON
2	LEE-NEUMAN Emmett, SK
3	HOLLIDAY Lyndon, BC
3	GRIGY Donovan, AB

CICATI	0		CICATI	10	IPC	C-102	CICATI	0	
BYE	0			0	MAKOWICHUK			0	
ROACH	0		CICATI	0		C-113	HOLLIDAY	10	IPC
BYE	0			0				HOLLIDAY	10
ROACH	0		CICATI	0		C-103	HOLLIDAY	5	WAZ
BYE	0			0				HOLLIDAY	10
BENNETT	0		BENNETT	0		C-104	LI	10	IPC
BYE	0			0				LI	10
SQUAREK	0		LI	10	IPC	C-114	SQUAREK	0	
BYE	0			0	SQUAREK			0	
SQUAREK	10	IPC	SQUAREK	10	IPC	C-105	LI	0	
BYE	0	0		AUSTMAN	0			C-105	

U14M -50 kg

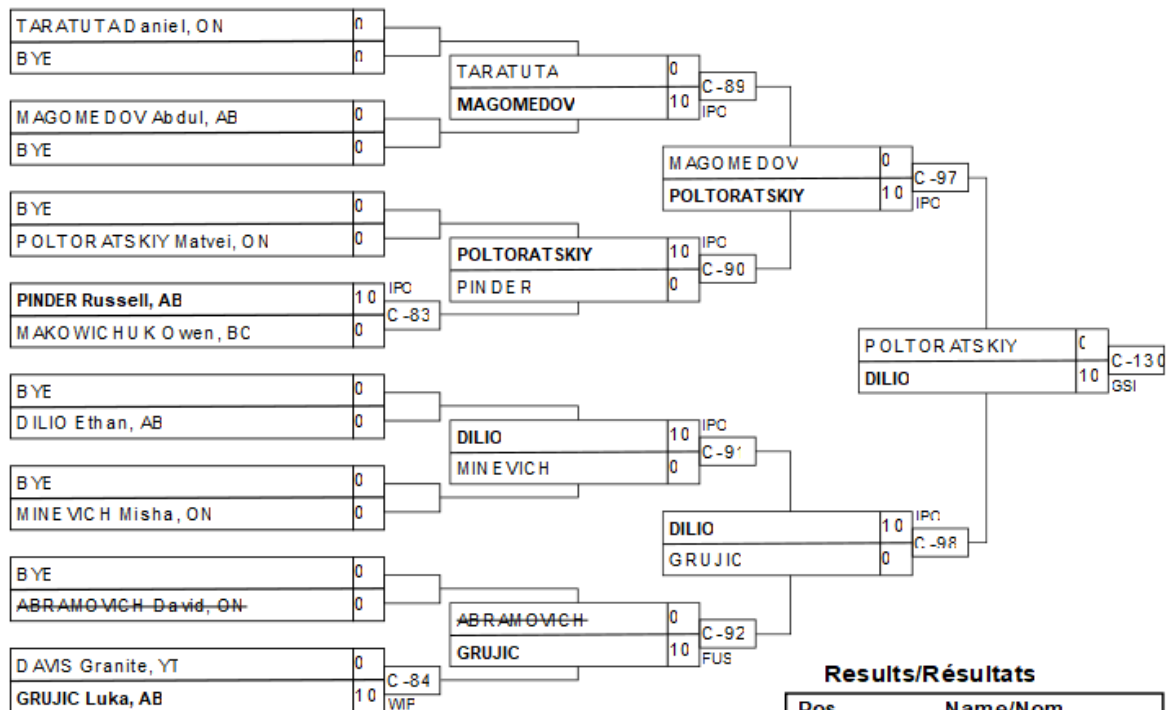

Pos	Name/Nom
1	DILIO Ethan, AB
2	POLTORATSKIY Matvei, ON
3	MAGOMEDOV Abdul, AB
3	TARATUTA Daniel, ON

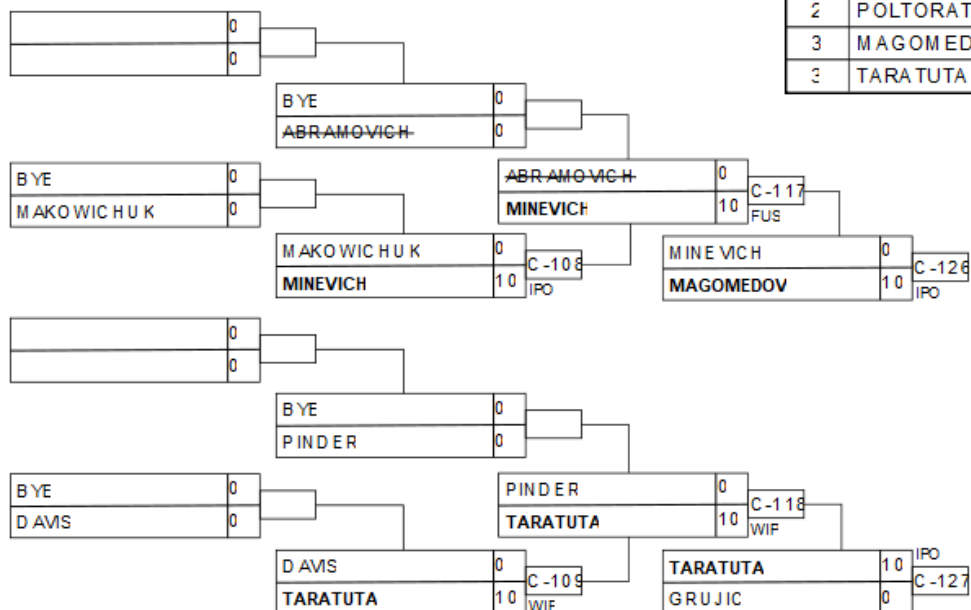

U14M -55 kg

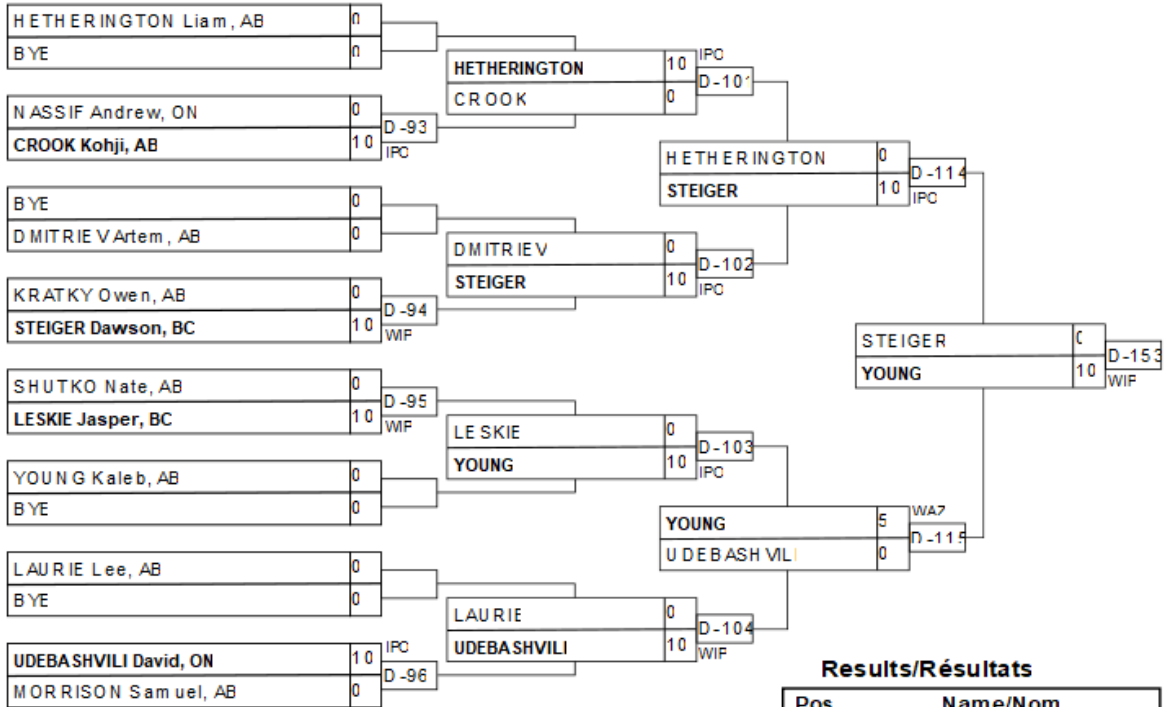

Results/Résultats

Pos	Name/Nom
1	YOUNG Kaleb, AB
2	STEIGER Dawson, BC
3	NASSIF Andrew, ON
3	MORRISON Samuel, AB

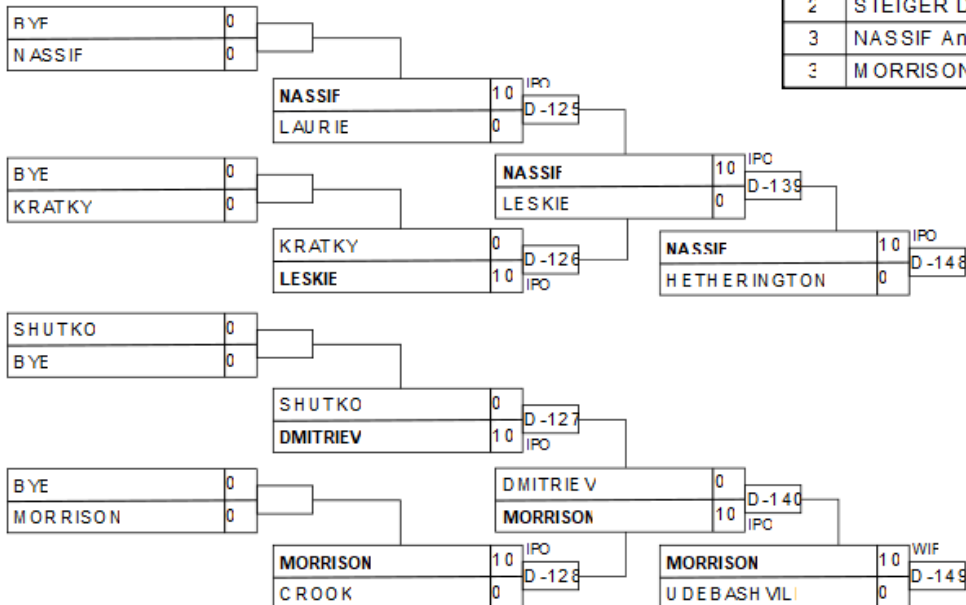

U14M -60 kg

Competitors/Compétiteurs A

#	Name/Nom	Club	1	2	3	4	W/G	Pts	Pos
1	TABOULCHANAS Alexander	AB	XX		10	10	2	20	2
2	NATSVLISHVILI Giorgi	ON	10	XX	10	10	3	30	1
3	ALDRED Liam	AV			XX		0	0	4
4	PRYSCHLAK Graham	BC			10	XX	1	10	3

Pool A

Match	White/Blanc			Blue/Bleu	Res/Rés	Tim/Tmp	Code
D-107	TABOULCHANAS Alexander	1	2	NATSVLISHVILI Giorgi	0 - 10	0:25	IPO
D-108	ALDRED Liam	3	4	PRYSCHLAK Graham	0 - 10	0:47	WIP
D-119	TABOULCHANAS Alexander	1	3	ALDRED Liam	10 - 0	0:10	IPO
D-120	NATSVLISHVILI Giorgi	2	4	PRYSCHLAK Graham	10 - 0	0:12	IPO
D-132	TABOULCHANAS Alexander	1	4	PRYSCHLAK Graham	10 - 0	1:17	IPO
D-133	NATSVLISHVILI Giorgi	2	3	ALDRED Liam	10 - 0	0:28	WIP

Competitors/Compétiteurs B

#	Name/Nom	Club	5	6	7	W/G	Pts	Pos
5	MISCU Matthew	AB	XX			0	0	3
6	BERNS Thomas	SK	10	XX		1	10	2
7	SOKOLOV Emelyan	ON	10	10	XX	2	20	1

Pool B

Match	White/Blanc			Blue/Bleu	Res/Rés	Tim/Tmp	Code
D-109	MISCU Matthew	5	6	BERNS Thomas	0 - 10	1:08	IPO
D-121	MISCU Matthew	5	7	SOKOLOV Emelyan	0 - 10	1:03	WIP
D-134	BERNS Thomas	6	7	SOKOLOV Emelyan	0 - 10	0:27	WIP

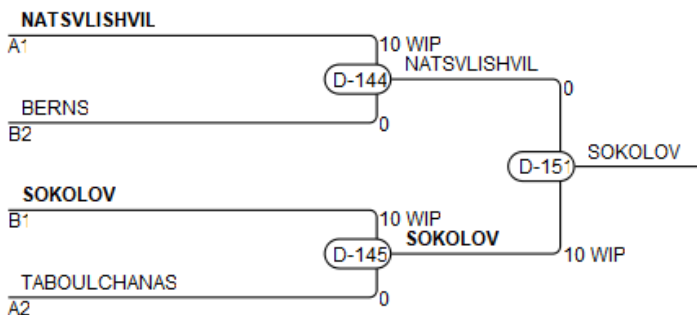

Results/Résultats

Pos	Name/Nom
1	SOKOLOV Emelyan, ON
2	NATSVLISHVILI Giorgi, ON
3	BERNS Thomas, SK
3	TABOULCHANAS Alexander, AB

U14M -66 kg

Competitors/Compétiteurs A

#	Name/Nom	Club	1	2	3	W/G	Pts	Pos
1	GABRIELE Lucas	ON	XX	10	10	2	20	1
2	HOLT Preston	BC		XX	10	1	10	2
3	WALTON Samuel	AB			XX	0	0	3

Pool A

Match	White/Blanc	Blue/Bleu	Res/Rés	Tim/Tmp	Code
D-105	GABRIELE Lucas 1 2	HOLT Preston	10 - 0	1:29	WIP
D-117	GABRIELE Lucas 1 3	WALTON Samuel	10 - 0	0:07	IPO
D-130	HOLT Preston 2 3	WALTON Samuel	10 - 0	0:29	WIP

Competitors/Compétiteurs B

#	Name/Nom	Club	4	5	6	W/G	Pts	Pos
4	CLARK Layne	BC	XX		10	1	10	2
5	ASGARZADEH Davud	AB	10	XX	10	2	20	1
6	BLANCHETTE Nicholas	BC			XX	0	0	3

Pool B

Match	White/Blanc	Blue/Bleu	Res/Rés	Tim/Tmp	Code
D-106	CLARK Layne 4 5	ASGARZADEH Davud	0 - 10	2:42	HAN
D-118	CLARK Layne 4 6	BLANCHETTE Nicholas	10 - 0	0:47	IPO
D-131	ASGARZADEH Davud 5 6	BLANCHETTE Nicholas	10 - 0	0:06	IPO

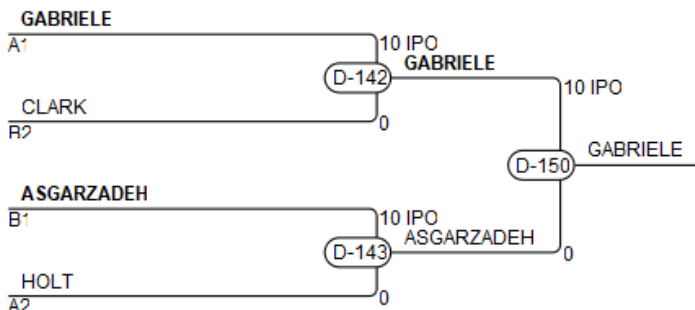

Results/Résultats

Pos	Name/Nom
1	GABRIELE Lucas, ON
2	ASGARZADEH Davud, AB
3	CLARK Layne, BC
3	HOLT Preston, BC

U14M +66 kg

Competitors/Compétiteurs

#	Name/Nom	Club	1	2	1	2	1	2	W/G	Pts	Pos
1	TUBMAN Nolan	BC	XX		XX		XX		0	0	2
2	MAPLE Dominik	BC	10	XX	10	XX		XX	2	20	1

Matches/Matches

Match	White/Blanc			Blue/Bleu	Res/Rés	Tim/Tmp	Code
C-101	TUBMAN Nolan	1	2	MAPLE Dominik	0 - 10	0:19	WIP
C-112	MAPLE Dominik	2	1	TUBMAN Nolan	10 - 0	0:45	IPO
C-121	TUBMAN Nolan	1	2	MAPLE Dominik			

Results/Résultats

Pos	Name/Nom
1	MAPLE Dominik, BC

U18F -44 kg

Competitors/Compétiteurs

#	Name/Nom	Club	1	2	1	2	1	2	W/G	Pts	Pos
1	KARAS Christina	AB	XX		XX		XX		0	0	2
2	MANIBOG Malia	Other	10	XX	10	XX		XX	2	20	1

Matches/Matches

Match	White/Blanc			Blue/Bleu	Res/Rés	Tim/Tmp	Code
D-190	KARAS Christina	1	2	MANIBOG Malia	0 - 10	2:32	WIP
D-199	MANIBOG Malia	2	1	KARAS Christina	10 - 0	0:09	IPO
D-204	KARAS Christina	1	2	MANIBOG Malia			

Results/Résultats

Pos	Name/Nom
1	MANIBOG Malia, Other

U18F -48 kg

Competitors/Compétiteurs A

#	Name/Nom	Club	1	2	3	4	W/G	Pts	Pos
1	GROOTEN Maegan	BC	XX		10		1	10	3
2	TAMURA Addyson	AB	10	XX	10	10	3	30	1
3	MESONGNIK Nicol	MB			XX		0	0	4
4	WHITTLE Gwen	BC	10		10	XX	2	20	2

Pool A

Match	White/Blanc	Blue/Bleu	Res/Rés	Tim/Tmp	Code
B-172	GROOTEN Maegan 1 2	TAMURA Addyson	0 - 10	0:29	IPO
B-173	MESONGNIK Nicol 3 4	WHITTLE Gwen	0 - 10	0:32	IPO
B-188	GROOTEN Maegan 1 3	MESONGNIK Nicol	10 - 0	1:29	IPO
B-189	TAMURA Addyson 2 4	WHITTLE Gwen	10 - 0	3:15	WIP
B-198	GROOTEN Maegan 1 4	WHITTLE Gwen	0 - 10	2:04	IPO
B-199	TAMURA Addyson 2 3	MESONGNIK Nicol	10 - 0	0:55	IPO

Competitors/Compétiteurs B

#	Name/Nom	Club	5	6	7	W/G	Pts	Pos
5	SANIKIDZE Elizabeth	AB	XX	10	10	2	20	1
6	KEIRSTEAD Wish	BC		XX	10	1	10	2
7	PENNER Beth	MB			XX	0	0	3

Pool B

Match	White/Blanc	Blue/Bleu	Res/Rés	Tim/Tmp	Code
B-174	SANIKIDZE Elizabeth 5 6	KEIRSTEAD Wish	10 - 0	0:25	WIP
B-190	SANIKIDZE Elizabeth 5 7	PENNER Beth	10 - 0	0:44	IPO
B-200	KEIRSTEAD Wish 6 7	PENNER Beth	10 - 0	1:52	IPO

TAMURA

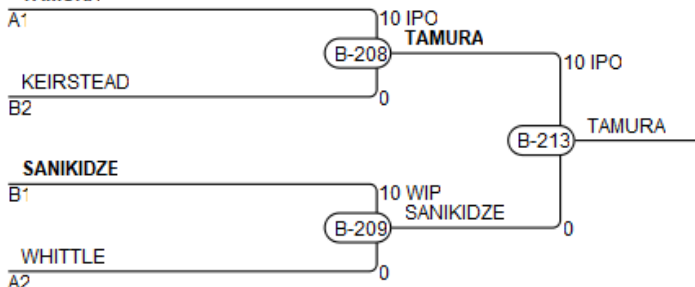

Results/Résultats

Pos	Name/Nom
1	TAMURA Addyson, AB
2	SANIKIDZE Elizabeth, AB
3	KEIRSTEAD Wish, BC
3	WHITTLE Gwen, BC

U18F -52 kg

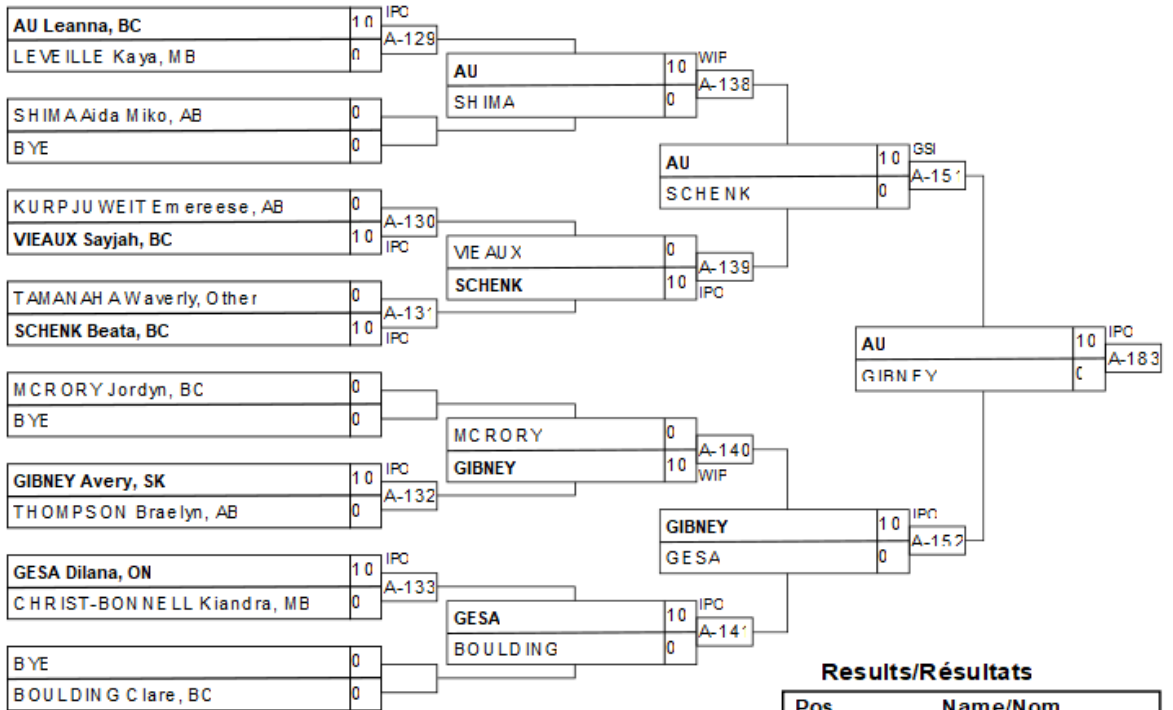

Results/Résultats

Pos	Name/Nom
1	AU Leanna, BC
2	GIBNEY Avery, SK
3	SCHENK Beata, BC
3	GESA Dilana, ON

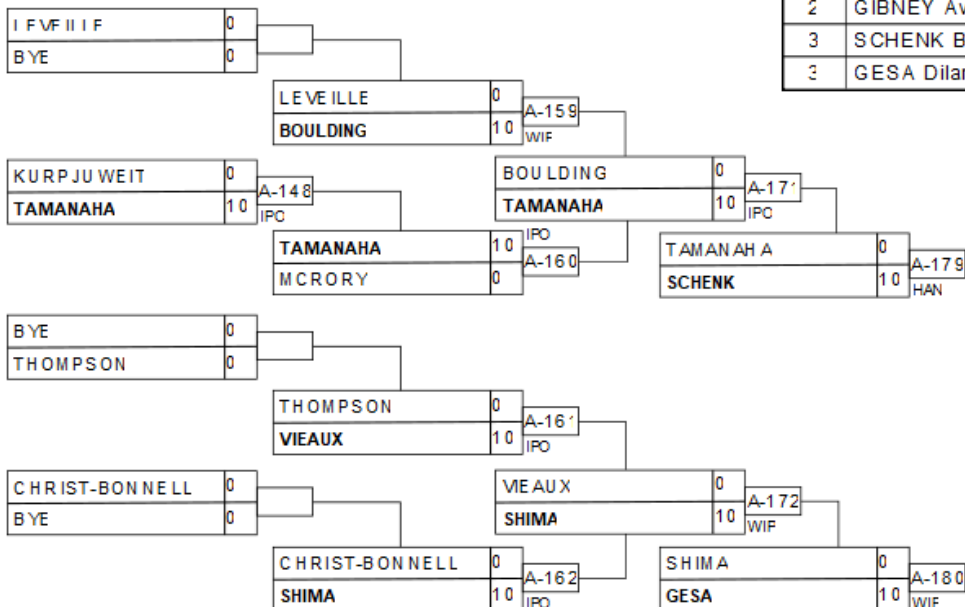

U18F -57 kg

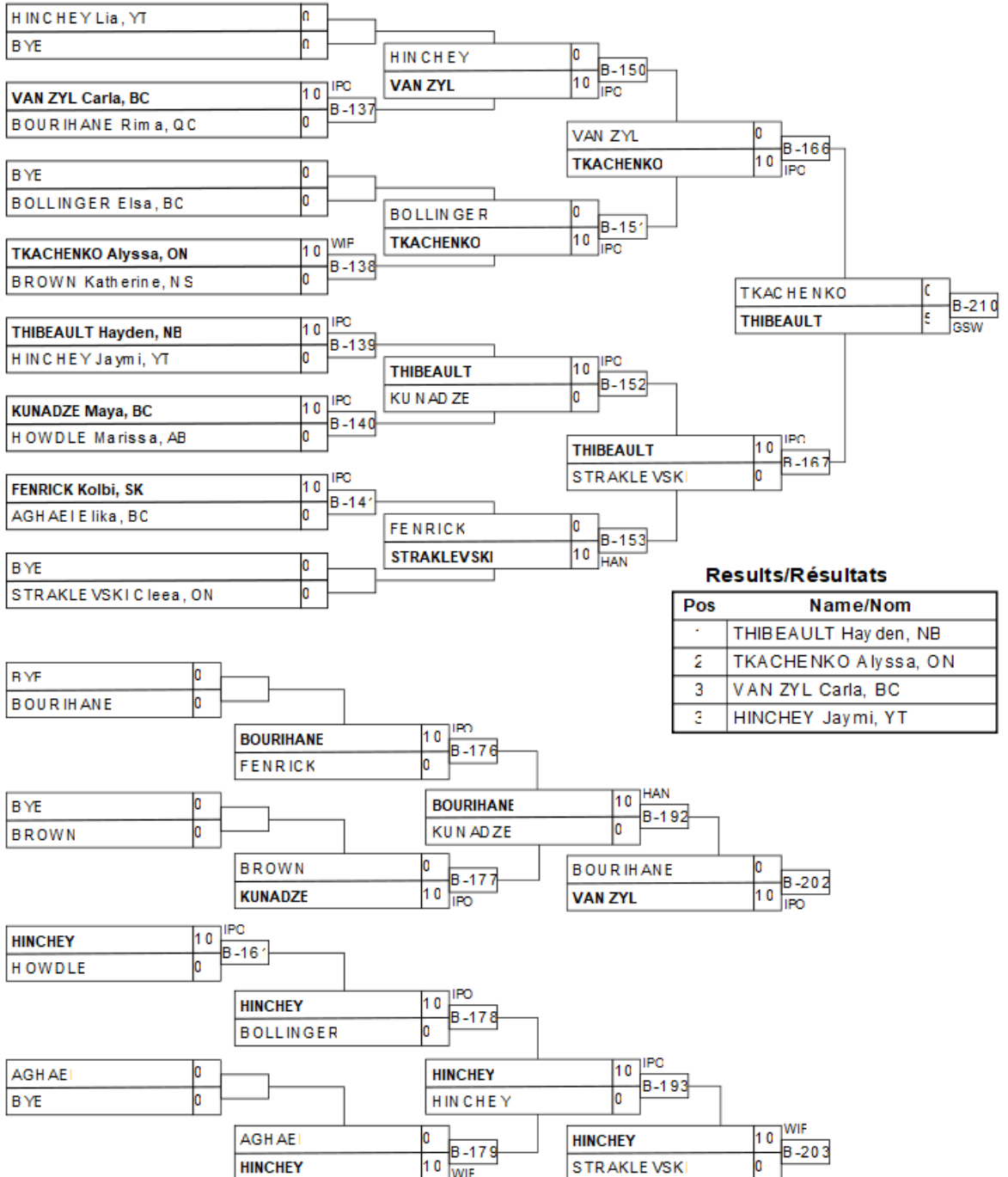

U18F -63 kg

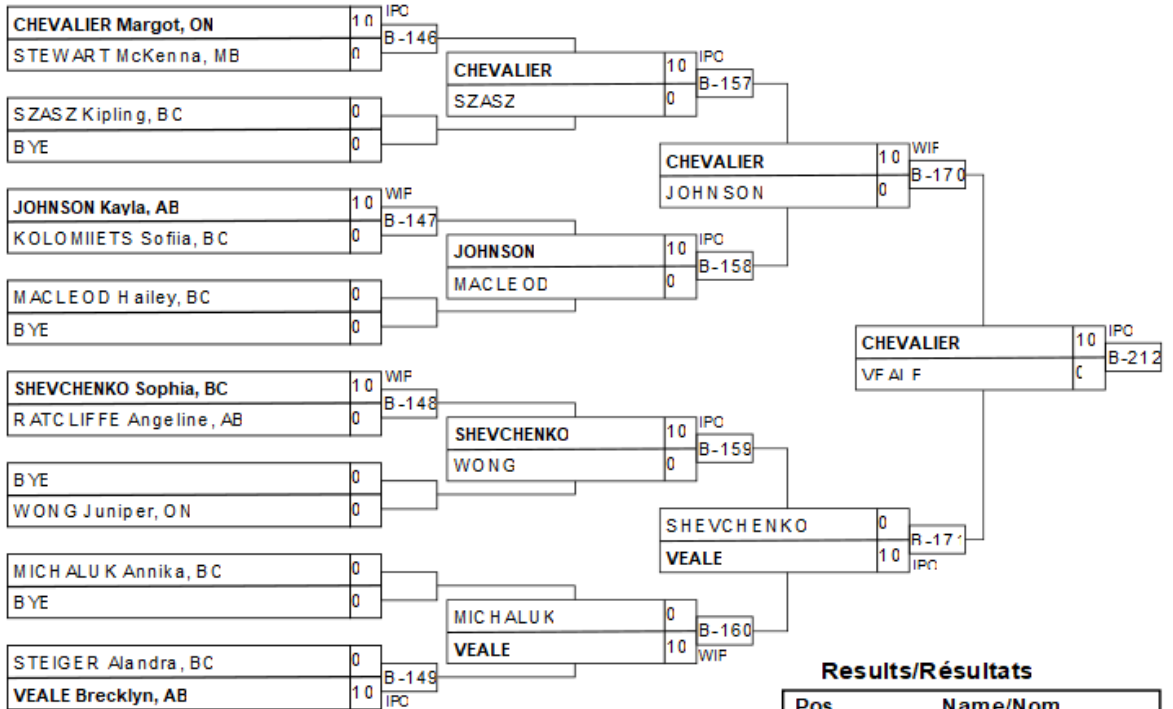

Results/Résultats

Pos	Name/Nom
1	CHEVALIER Margot, ON
2	VEALE Brecklyn, AB
3	JOHNSON Kayla, AB
3	SHEVCHENKO Sophia, BC

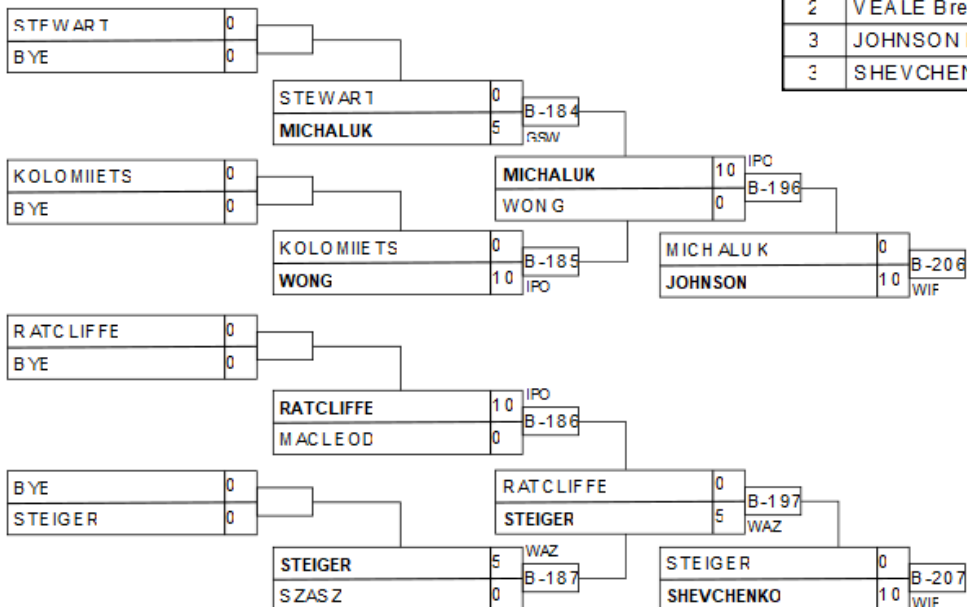

U18F -70 kg

Competitors/Compétiteurs A

#	Name/Nom	Club	1	2	3	4	W/G	Pts	Pos
1	YIN Hannah	BC	XX		10	10	2	20	2
2	BATBAYAR Maralgoo	AB	10	XX	10	10	3	30	1
3	ALIYEVA Emiliya	AB			XX	10	1	10	3
4	JOLICOEUR Haylee	ON				XX	0	0	4

Pool A

Match	White/Blanc			Blue/Bleu	Res/Rés	Tim/Tmp	Code
C-155	YIN Hannah	1	2	BATBAYAR Maralgoo	0 - 10	0:52	IPO
C-156	ALIYEVA Emiliya	3	4	JOLICOEUR Haylee	10 - 0	0:06	IPO
C-163	YIN Hannah	1	3	ALIYEVA Emiliya	10 - 0	2:23	IPO
C-164	BATBAYAR Maralgoo	2	4	JOLICOEUR Haylee	10 - 0	1:23	IPO
C-173	YIN Hannah	1	4	JOLICOEUR Haylee	10 - 0	1:03	WIP
C-174	BATBAYAR Maralgoo	2	3	ALIYEVA Emiliya	10 - 0	0:13	IPO

Competitors/Compétiteurs B

#	Name/Nom	Club	5	6	7	W/G	Pts	Pos
5	SMITH Abigail	NS	XX			0	0	3
6	COSSITT Elizabeth	AB	10	XX		1	10	2
7	ROTBART Nova	BC	10	10	XX	2	20	1

Pool B

Match	White/Blanc			Blue/Bleu	Res/Rés	Tim/Tmp	Code
C-157	SMITH Abigail	5	6	COSSITT Elizabeth	0 - 10	1:12	IPO
C-165	SMITH Abigail	5	7	ROTBART Nova	0 - 10	1:17	IPO
C-175	COSSITT Elizabeth	6	7	ROTBART Nova	0 - 10	2:43	HAN

BATBAYAR

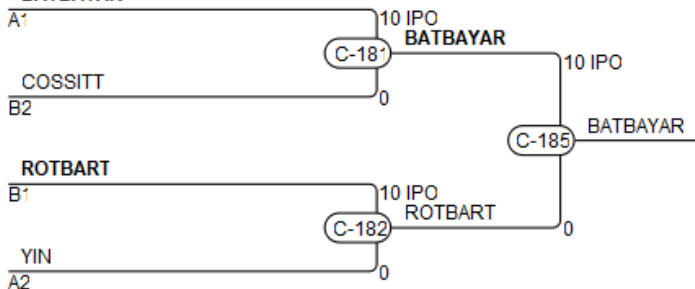

Results/Résultats

Pos	Name/Nom
1	BATBAYAR Maralgoo, AB
2	ROTBART Nova, BC
3	COSSITT Elizabeth, AB
3	YIN Hannah, BC

U18F +70 kg

Competitors/Compétiteurs

#	Name/Nom	Club	1	2	3	W/G	Pts	Pos
1	HRYNIW Jasmyne	AB	XX			0	0	3
2	KARAS Marianna	AB	10	XX	10	2	20	1
3	FOWLER Naomi	NB	10		XX	1	10	2

Matches/Matches

Match	White/Blanc			Blue/Bleu	Res/Rés	Tim/Tmp	Code
A-155	HRYNIW Jasmyne	1	2	KARAS Marianna	0 - 10	0:19	IPO
A-167	HRYNIW Jasmyne	1	3	FOWLER Naomi	0 - 10	0:09	IPO
A-175	KARAS Marianna	2	3	FOWLER Naomi	10 - 0	1:56	IPO

Results/Résultats

Pos	Name/Nom
1	KARAS Marianna, AB
2	FOWLER Naomi, NB

U18F Novice -52 kg

Competitors/Compétiteurs

#	Name/Nom	Club	1	2	1	2	1	2	W/G	Pts	Pos
1	COBO Delfina	AB	XX		XX	5	XX	5	2	10	1
2	SCHIMANN Madeleine	BC	10	XX		XX		XX	1	10	2

Matches/Matches

Match	White/Blanc			Blue/Bleu	Res/Rés	Tim/Tmp	Code
A-158	COBO Delfina	1	2	SCHIMANN Madeleine	0 - 10	1:31	IPO
A-170	SCHIMANN Madeleine	2	1	COBO Delfina	0 - 5	4:00	WAZ
A-178	COBO Delfina	1	2	SCHIMANN Madeleine	5 - 0	4:00	WAZ

Results/Résultats

Pos	Name/Nom
1	COBO Delfina, AB
2	SCHIMANN Madeleine, BC

U18M -46 kg

Competitors/Compétiteurs

#	Name/Nom	Club	1	2	3	4	5	W/G	Pts	Pos
1	KO Logan	BC	XX			10	10	2	20	3
2	WEBBER Justin	AB	5	XX	10	10	10	4	35	1
3	MCLEAN Elias	NB	10		XX	10	10	3	30	2
4	RAMSEY Max	BC				XX		0	0	5
5	HINTON Tobin	BC				10	XX	1	10	4

Matches/Matches

Match	White/Blanc			Blue/Bleu	Res/Rés	Tim/Tmp	Code
C-147	RAMSEY Max	4	5	HINTON Tobin	0 - 10	3:43	WIP
C-148	KO Logan	1	2	WEBBER Justin	0 - 5	4:17	GSW
C-153	MCLEAN Elias	3	4	RAMSEY Max	10 - 0	1:25	IPO
C-154	KO Logan	1	5	HINTON Tobin	10 - 0	1:00	IPO
C-160	WEBBER Justin	2	3	MCLEAN Elias	10 - 0	2:25	WIP
C-161	KO Logan	1	4	RAMSEY Max	10 - 0	0:10	IPO
C-170	MCLEAN Elias	3	5	HINTON Tobin	10 - 0	2:24	WIP
C-171	WEBBER Justin	2	4	RAMSEY Max	10 - 0	0:44	WIP
C-178	KO Logan	1	3	MCLEAN Elias	0 - 10	1:35	IPO
C-179	WEBBER Justin	2	5	HINTON Tobin	10 - 0	1:33	IPO

Results/Résultats

Pos	Name/Nom
1	WEBBER Justin, AB
2	MCLEAN Elias, NB
3	KO Logan, BC
4	HINTON Tobin, BC

U18M -50 kg

Competitors/Compétiteurs

#	Name/Nom	Club	1	2	3	4	5	W/G	Pts	Pos
1	JOHNSON Kohen	AB	XX					0	0	5
2	ROITMAN Arel	ON	10	XX	10	10		3	30	2
3	YANAGI Garrett	Other	10		XX	5		2	15	3
4	KLYMENKO Max	BC	10			XX		1	10	4
5	TEMIRBAEV Amir	BC	10	5	10	10	XX	4	35	1

Matches/Matches

Match	White/Blanc			Blue/Bleu	Res/Rés	Tim/Tmp	Code
A-146	KLYMENKO Max	4	5	TEMIRBAEV Amir	0 - 10	1:35	IPO
A-147	JOHNSON Kohen	1	2	ROITMAN Arel	0 - 10	0:20	IPO
A-149	YANAGI Garrett	3	4	KLYMENKO Max	5 - 0	2:20	WAZ
A-150	JOHNSON Kohen	1	5	TEMIRBAEV Amir	0 - 10	0:45	IPO
A-156	ROITMAN Arel	2	3	YANAGI Garrett	10 - 0	0:40	IPO
A-157	JOHNSON Kohen	1	4	KLYMENKO Max	0 - 10	0:39	IPO
A-168	YANAGI Garrett	3	5	TEMIRBAEV Amir	0 - 10	0:00	FUS
A-169	ROITMAN Arel	2	4	KLYMENKO Max	10 - 0	3:16	IPO
A-176	JOHNSON Kohen	1	3	YANAGI Garrett	0 - 10	1:40	IPO
A-177	ROITMAN Arel	2	5	TEMIRBAEV Amir	0 - 5	4:22	GSW

Results/Résultats

Pos	Name/Nom
1	TEMIRBAEV Amir, BC
2	ROITMAN Arel, ON
3	YANAGI Garrett, Other
4	KLYMENKO Max, BC

U18M -50 kg (TB)

Competitors/Compétiteurs

#	Name/Nom	Club	1	2	3	W/G	Pts	Pos
1	JOHNSON Kohen	AB	XX			0	0	3
2	YANAGI Garrett	Other	10	XX	5	2	15	1
3	KLYMENKO Max	BC	10		XX	1	10	2

Matches/Matches

Match	White/Blanc			Blue/Bleu	Res/Rés	Tim/Tmp	Code
A-184A	JOHNSON Kohen	1	2	YANAGI Garrett	0 - 10	1:40	IPO
A-188A	JOHNSON Kohen	1	3	KLYMENKO Max	0 - 10	0:39	IPO
A-193A	YANAGI Garrett	2	3	KLYMENKO Max	5 - 0	2:20	GSW

Results/Résultats

Pos	Name/Nom
1	YANAGI Garrett, Other
2	KLYMENKO Max, BC

U18M -55 kg

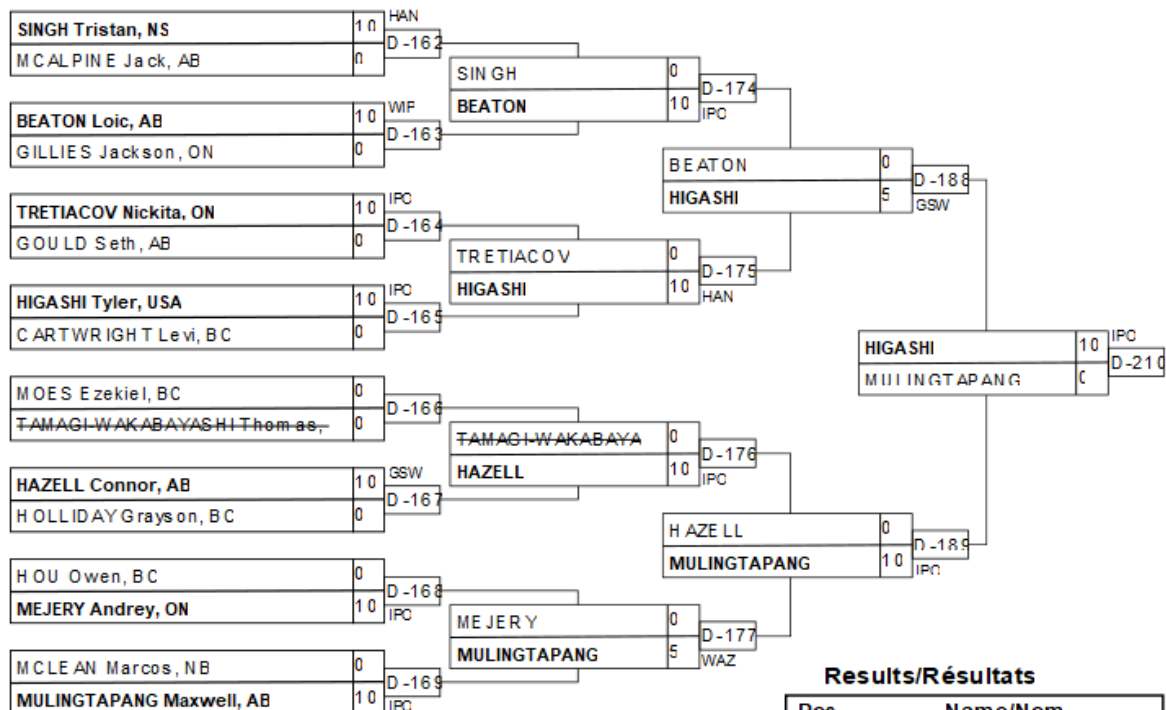

Results/Résultats

Pos	Name/Nom
1	HIGASHI Tyler, USA
2	MULINGTAPANG Maxwell, AB
3	BEATON Loic, AB
3	TRETIACOV Nickita, ON

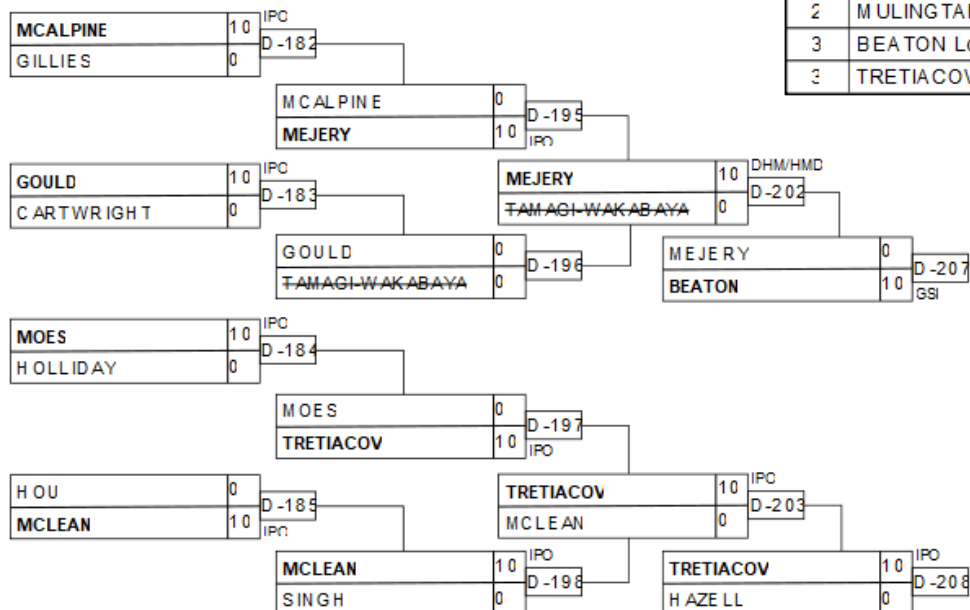

U18M -60 kg

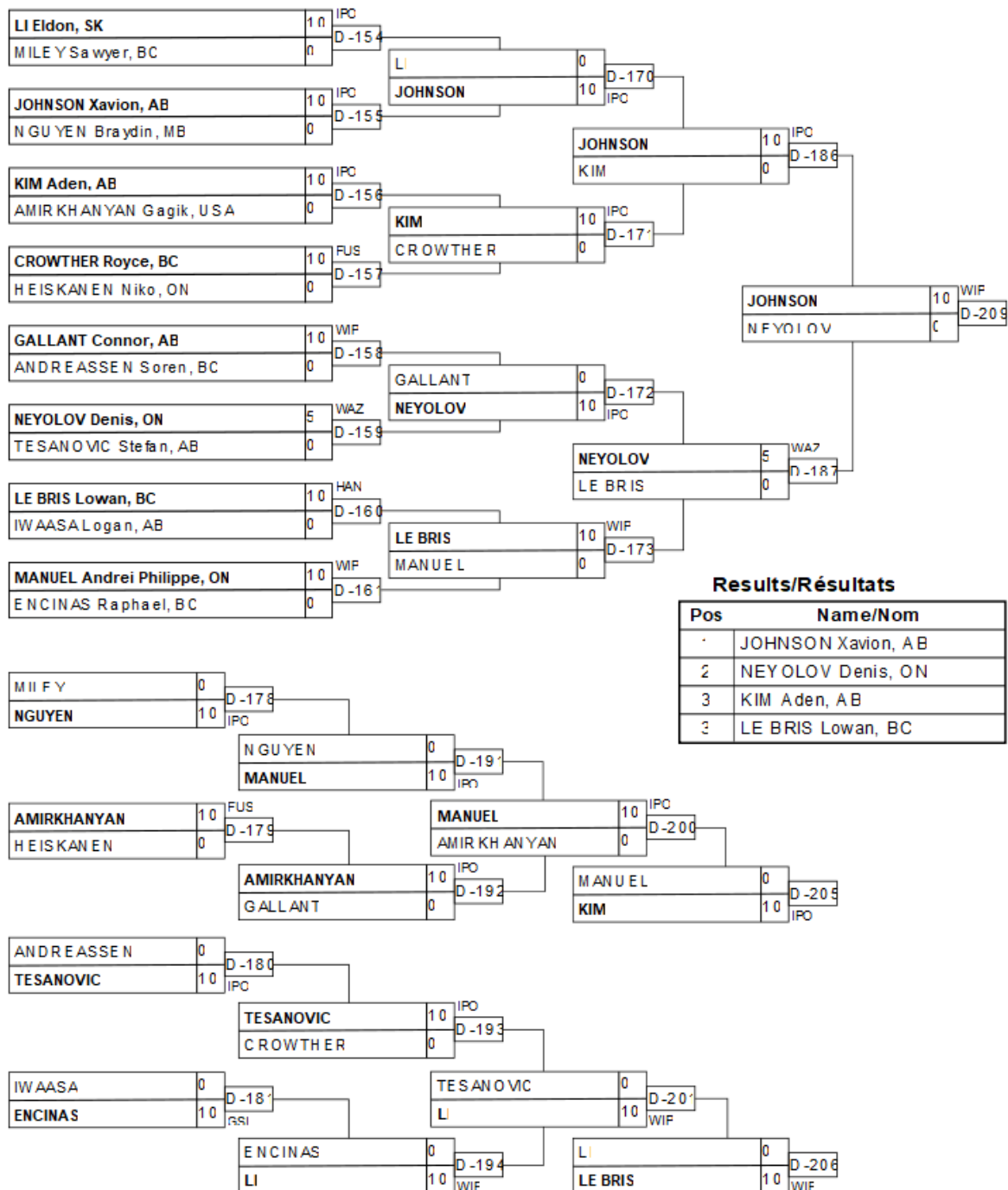

U18M -66 kg

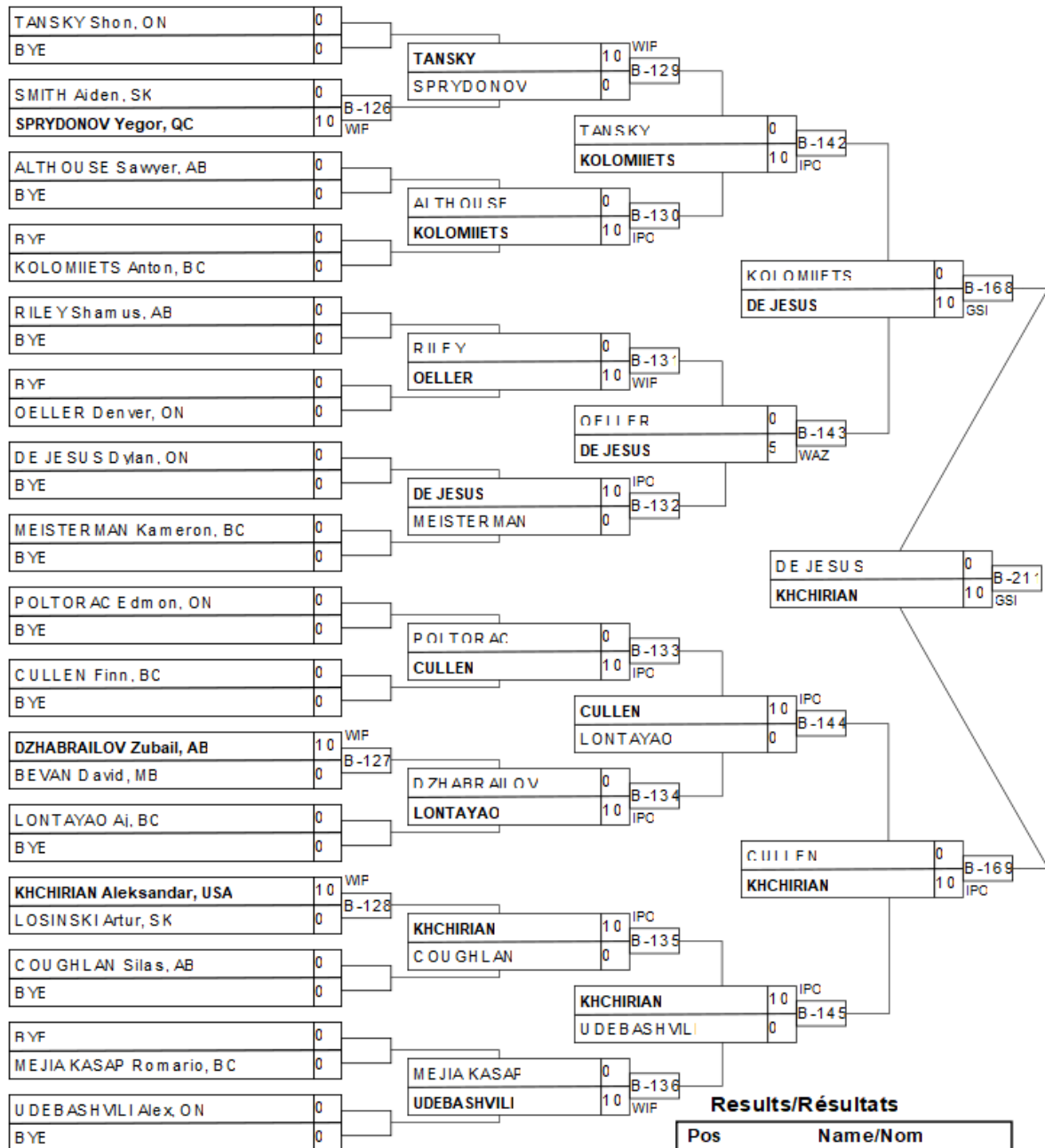

Results/Résultats

Pos	Name/Nom
1	KHCHIRIAN Aleksandar, US
2	DE JESUS Dylan, ON
3	KOLOMIETS Anton, BC
3	TANSKY Shon, ON

U18M -73 kg

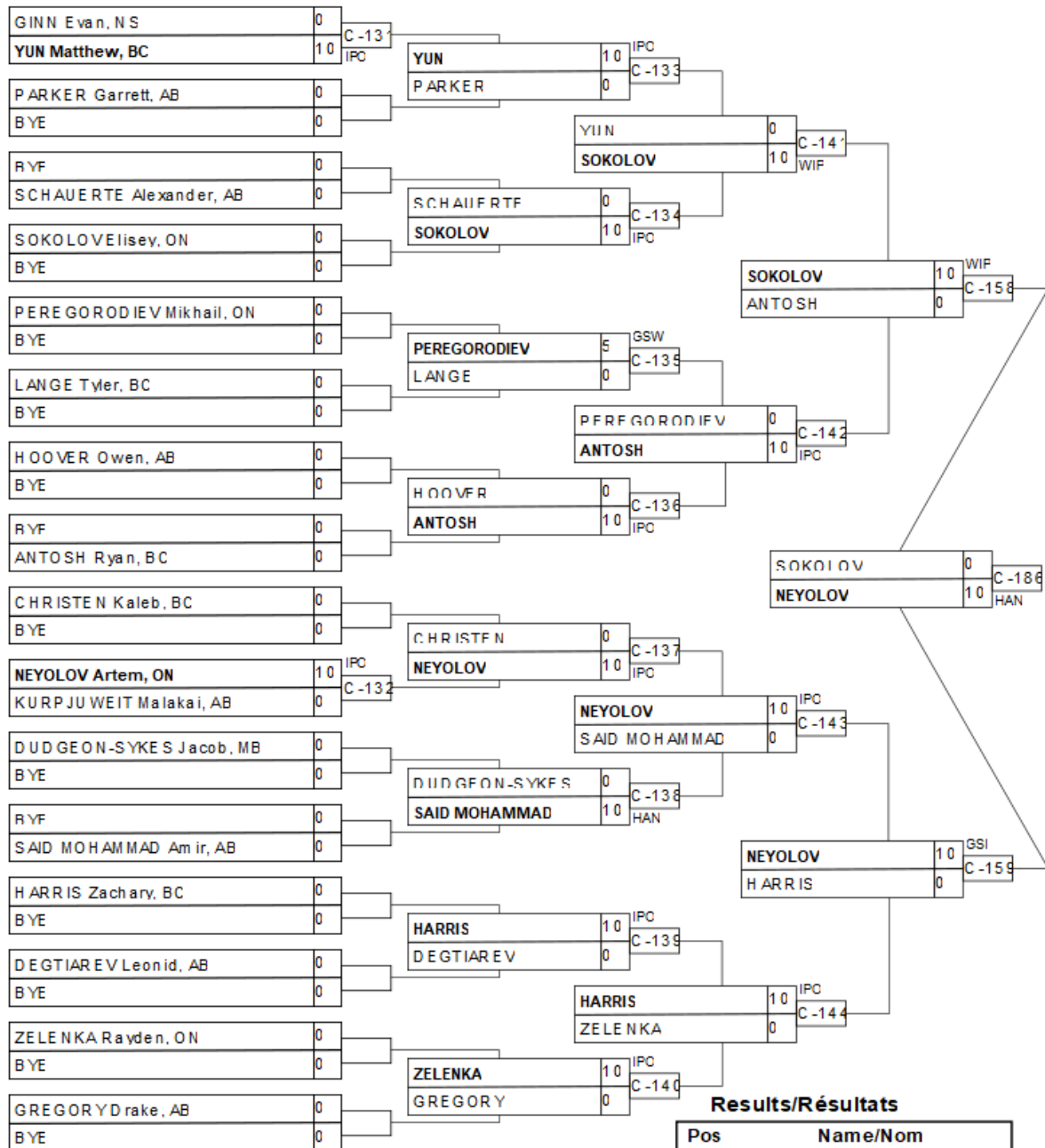

Results/Résultats

Pos	Name/Nom
1	NEYOLOV Artem, ON
2	SOKOLOV Elisey, ON
3	HOOVER Owen, AB
3	HARRIS Zachary, BC

U18M -81 kg

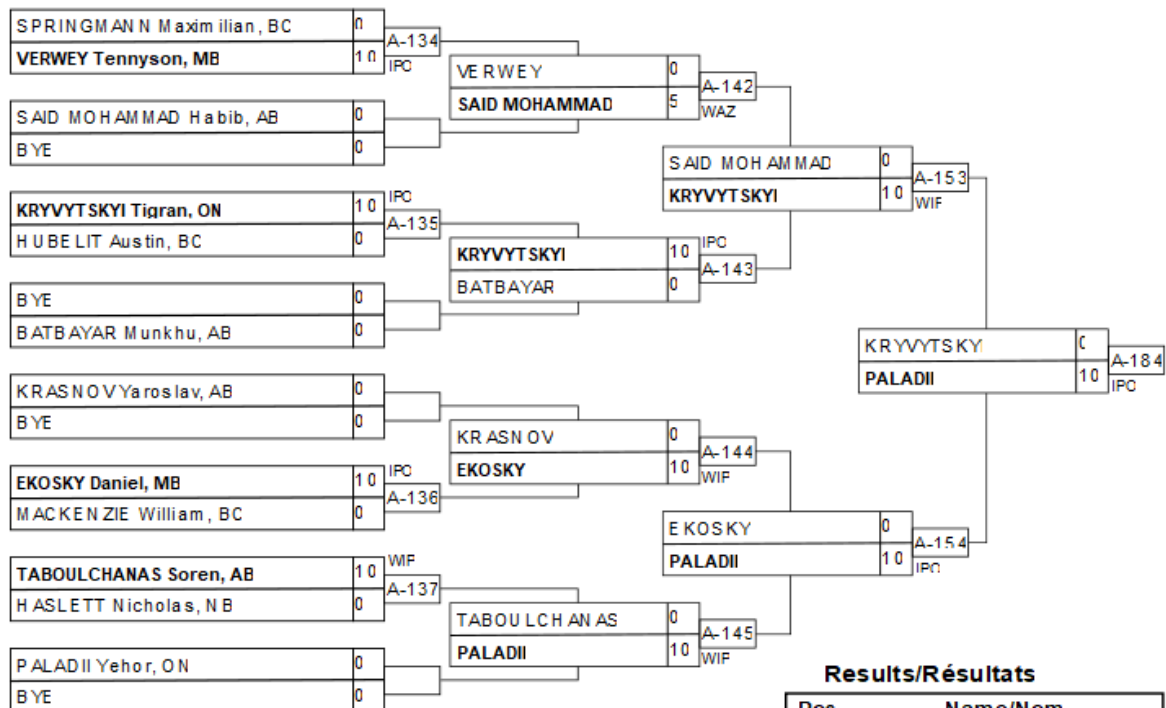

Results/Résultats

Pos	Name/Nom
1	PALADII Yehor, ON
2	KRYVYTSKYI Tigran, ON
3	SAID MOHAMMAD Habib, AB
3	EKOSKY Daniel, ME

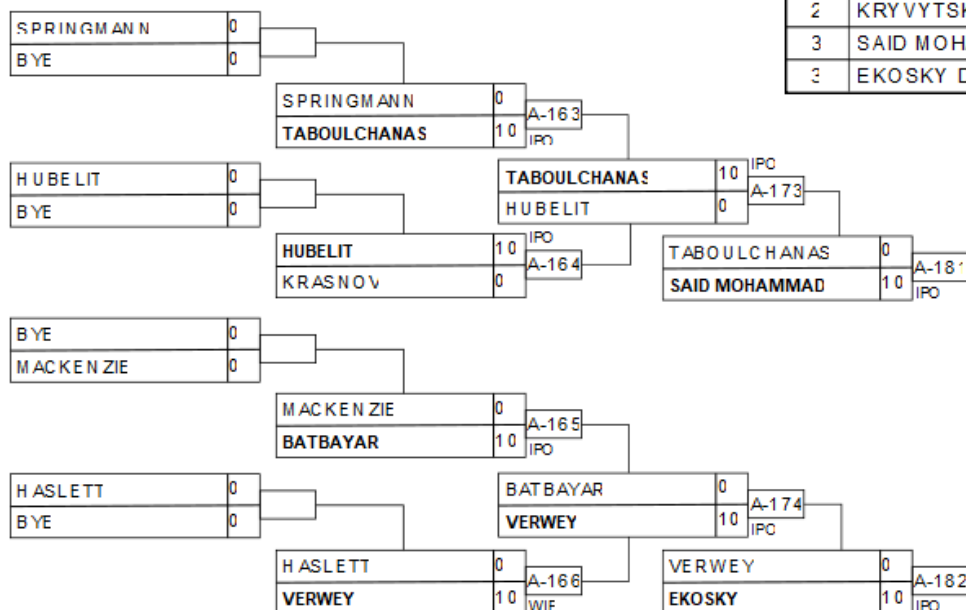

U18M -90 kg

Competitors/Compétiteurs

#	Name/Nom	Club	1	2	3	W/G	Pts	Pos
1	KAPLIN Sasha	NS	XX	10	10	2	20	1
2	KHALFON Eden	ON		XX	10	1	10	2
3	KHORTIV Roman	AB			XX	0	0	3

Matches/Matches

Match	White/Blanc			Blue/Bleu	Res/Rés	Tim/Tmp	Code
B-175	KAPLIN Sasha	1	2	KHALFON Eden	10 - 0	0:19	WIP
B-191	KAPLIN Sasha	1	3	KHORTIV Roman	10 - 0	0:36	IPO
B-201	KHALFON Eden	2	3	KHORTIV Roman	10 - 0	0:40	IPO

Results/Résultats

Pos	Name/Nom
1	KAPLIN Sasha, NS
2	KHALFON Eden, ON

U18M +90 kg

Competitors/Compétiteurs

#	Name/Nom	Club	1	2	3	W/G	Pts	Pos
1	KYMANICK Dalin	MB	XX			0	0	3
2	RAINVILLE Matys	QC	10	XX		1	10	2
3	UEYAMA Kanta	Other	10	10	XX	2	20	1

Matches/Matches

Match	White/Blanc			Blue/Bleu	Res/Rés	Tim/Tmp	Code
C-162	KYMANICK Dalin	1	2	RAINVILLE Matys	0 - 10	0:26	WIP
C-172	KYMANICK Dalin	1	3	UEYAMA Kanta	0 - 10	0:06	IPO
C-180	RAINVILLE Matys	2	3	UEYAMA Kanta	0 - 10	2:10	WIP

Results/Résultats

Pos	Name/Nom
1	UEYAMA Kanta, Other
2	RAINVILLE Matys, QC

U21F -48 kg

Competitors/Compétiteurs

#	Name/Nom	Club	1	2	1	2	1	2	W/G	Pts	Pos
1	ORTIZ Monica	QC	XX	10	XX	10	XX		2	20	1
2	MCCRISTALL Angelina	ON		XX		XX		XX	0	0	2

Matches/Matches

Match	White/Blanc			Blue/Bleu	Res/Rés	Tim/Tmp	Code
D-214	ORTIZ Monica	1	2	MCCRISTALL Angelina	10 - 0	0:16	IPO
D-218	MCCRISTALL Angelina	2	1	ORTIZ Monica	0 - 10	1:35	IPO
D-222	ORTIZ Monica	1	2	MCCRISTALL Angelina			

Results/Résultats

Pos	Name/Nom
1	ORTIZ Monica, QC

U21F -52 kg

Competitors/Compétiteurs

#	Name/Nom	Club	1	2	3	W/G	Pts	Pos
1	SHEARER Lola	BC	XX		5	1	5	2
2	TKACHENKO Dasha	ON	10	XX	10	2	20	1
3	YANAGI Tiffany	Other			XX	0	0	3

Matches/Matches

Match	White/Blanc			Blue/Bleu	Res/Rés	Tim/Tmp	Code
C-207	SHEARER Lola	1	2	TKACHENKO Dasha	0 - 10	3:10	WIP
C-212	SHEARER Lola	1	3	YANAGI Tiffany	5 - 0	4:00	WAZ
C-217	TKACHENKO Dasha	2	3	YANAGI Tiffany	10 - 0	1:34	IPO

Results/Résultats

Pos	Name/Nom
1	TKACHENKO Dasha, ON
2	SHEARER Lola, BC

U21F -57 kg

Competitors/Compétiteurs

#	Name/Nom	Club	1	2	1	2	1	2	W/G	Pts	Pos
1	KOLIASKA Aliya	AB	XX	10	XX	10	XX		2	20	1
2	MANUEL Alyssandra Phoebe	ON		XX		XX		XX	0	0	2

Matches/Matches

Match	White/Blanc			Blue/Bleu	Res/Rés	Tim/Tmp	Code
B-216	KOLIASKA Aliya	1	2	MANUEL Alyssandra Phoebe	10 - 0	0:59	WIP
B-219	MANUEL Alyssandra Phoebe	2	1	KOLIASKA Aliya	0 - 10	1:45	WIP
B-222	KOLIASKA Aliya	1	2	MANUEL Alyssandra Phoebe			

Results/Résultats

Pos	Name/Nom
1	KOLIASKA Aliya, AB

U21F -63 kg

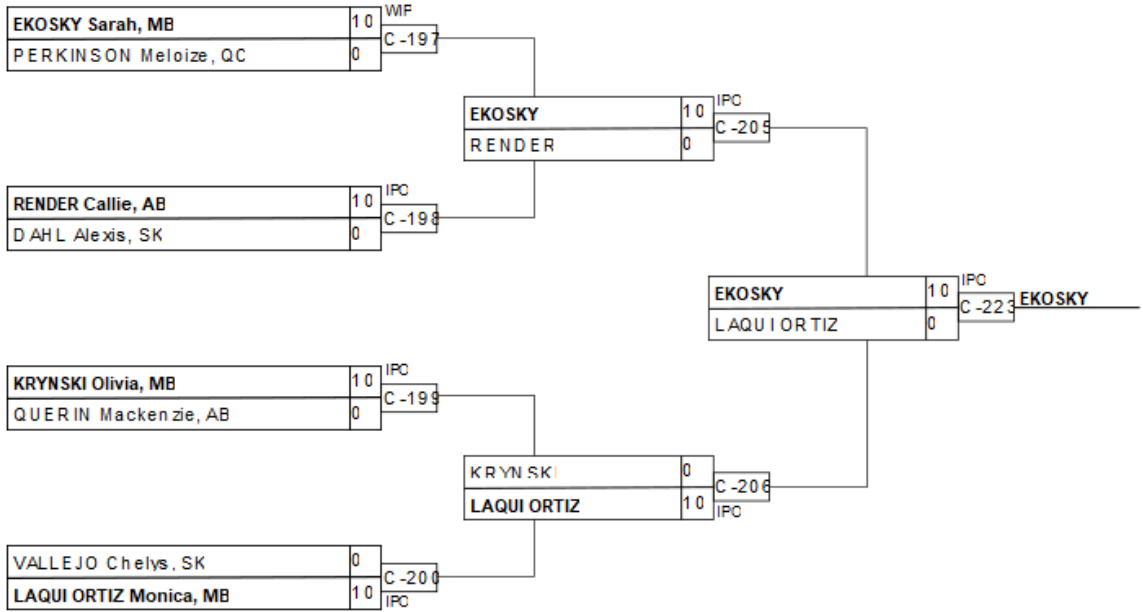

Results/Résultats

Pos	Name/Nom
1	EKOSKY Sarah, MB
2	LAQUI ORTIZ Monica, MB
3	RENDER Callie, AB
3	PERKINSON Meloize, QC

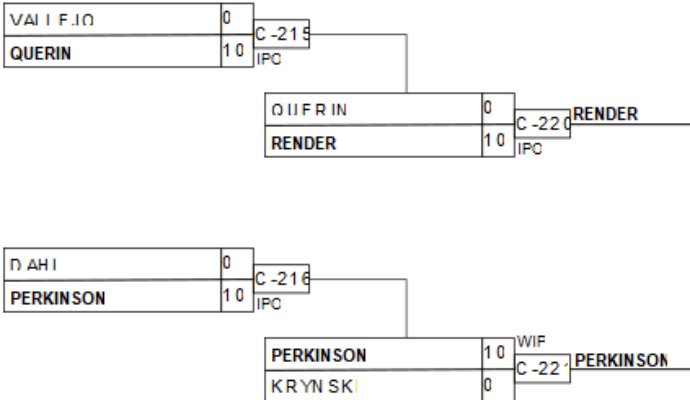

U21F -78 kg

Competitors/Compétiteurs

#	Name/Nom	Club	1	2	1	2	1	2	W/G	Pts	Pos
1	HARRIS Emily	ON	XX		XX		XX		0	0	2
2	MACDONALD Meadow	AB	10	XX	10	XX		XX	2	20	1

Matches/Matches

Match	White/Blanc			Blue/Bleu	Res/Rés	Tim/Tmp	Code
A-198	HARRIS Emily	1	2	MACDONALD Meadow	0 - 10	0:32	WIP
A-206	MACDONALD Meadow	2	1	HARRIS Emily	10 - 0	1:26	WIP
A-214	HARRIS Emily	1	2	MACDONALD Meadow			

Results/Résultats

Pos	Name/Nom
1	MACDONALD Meadow, AB

U21M -100 kg

Competitors/Compétiteurs

#	Name/Nom	Club	1	2	3	4	W/G	Pts	Pos
1	KURPJUWEIT Judah	AB	XX	10			1	10	3
2	HRONOPOULOS Christopher	AB		XX			0	0	4
3	VELASQUEZ KASAP Abel	BC	10	10	XX		2	20	2
4	HALLETT Josiah	SK	10	10	5	XX	3	25	1

Matches/Matches

Match	White/Blanc			Blue/Bleu	Res/Rés	Tim/Tmp	Code
B-214	KURPJUWEIT Judah	1	2	HRONOPOULOS Christopher	10 - 0	1:29	IPO
B-215	VELASQUEZ KASAP Abel	3	4	HALLETT Josiah	0 - 5	4:34	GSW
B-217	KURPJUWEIT Judah	1	3	VELASQUEZ KASAP Abel	0 - 10	1:03	IPO
B-218	HRONOPOULOS Christopher	2	4	HALLETT Josiah	0 - 10	0:42	IPO
B-220	KURPJUWEIT Judah	1	4	HALLETT Josiah	0 - 10	0:00	FUS
B-221	HRONOPOULOS Christopher	2	3	VELASQUEZ KASAP Abel	0 - 10	2:26	IPO

Results/Résultats

Pos	Name/Nom
1	HALLETT Josiah, SK
2	VELASQUEZ KASAP Abel, BC
3	KURPJUWEIT Judah, AB

U21M -60 kg

Competitors/Compétiteurs A

#	Name/Nom	Club	1	2	3	W/G	Pts	Pos
1	HAYNE Ethan	BC	XX			0	0	3
2	GRANT Eli	BC	10	XX		1	10	2
3	TREMBLAY Tayven	AB	10	10	XX	2	20	1

Pool A

Match	White/Blanc	Blue/Bleu	Res/Rés	Tim/Tmp	Code
A-191	HAYNE Ethan 1 2	GRANT Eli	0 - 10	3:19	WIP
A-199	HAYNE Ethan 1 3	TREMBLAY Tayven	0 - 10	0:12	IPO
A-207	GRANT Eli 2 3	TREMBLAY Tayven	0 - 10	3:02	IPO

Competitors/Compétiteurs B

#	Name/Nom	Club	4	5	6	W/G	Pts	Pos
4	ARUTYUNYAN Robert	BC	XX	10	10	2	20	1
5	MACINNIS Julian	AB		XX		0	0	3
6	WONG Jaime	BC		10	XX	1	10	2

Pool B

Match	White/Blanc	Blue/Bleu	Res/Rés	Tim/Tmp	Code
A-192	ARUTYUNYAN Robert 4 5	MACINNIS Julian	10 - 0	1:32	WIP
A-200	ARUTYUNYAN Robert 4 6	WONG Jaime	10 - 0	2:02	IPO
A-208	MACINNIS Julian 5 6	WONG Jaime	0 - 10	0:47	IPO

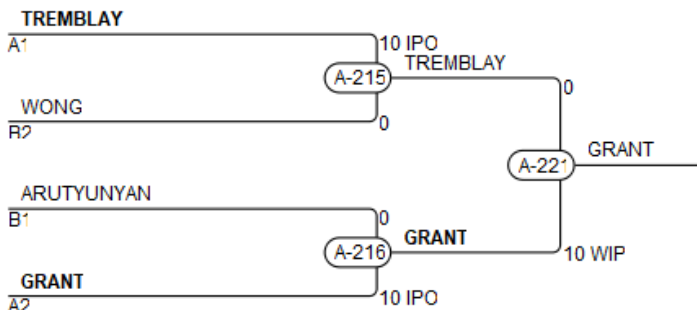

Results/Résultats

Pos	Name/Nom
1	GRANT Eli, BC
2	TREMBLAY Tayven, AB
3	WONG Jaime, BC
3	ARUTYUNYAN Robert, BC

U21M -66 kg

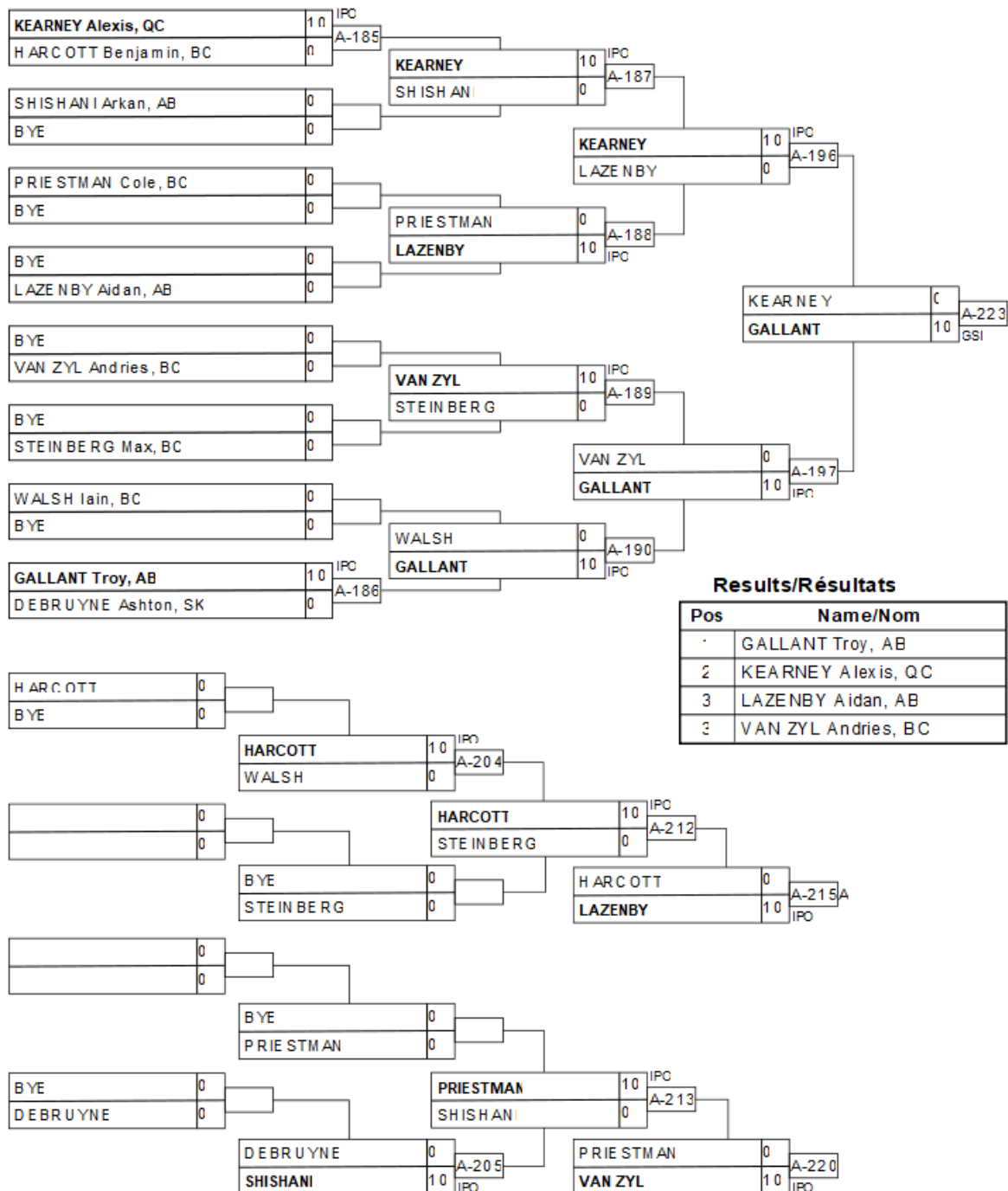

Results/Résultats

Pos	Name/Nom
1	GALLANT Troy, AB
2	KEARNEY Alexis, QC
3	LAZENBY Aidan, AB
3	VAN ZYL Andries, BC

U21M -73 kg

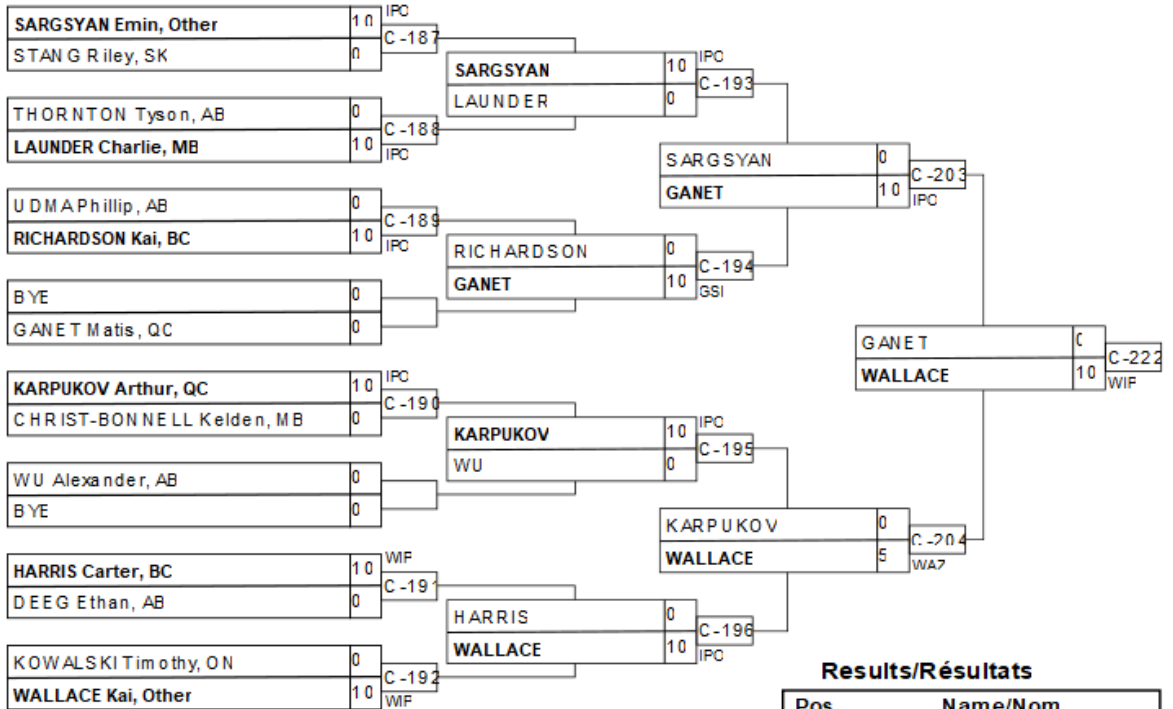

Results/Résultats

Pos	Name/Nom
1	WALLACE Kai, Other
2	GANET Matis, QC
3	HARRIS Carter, BC
3	KARPUKOV Arthur, QC

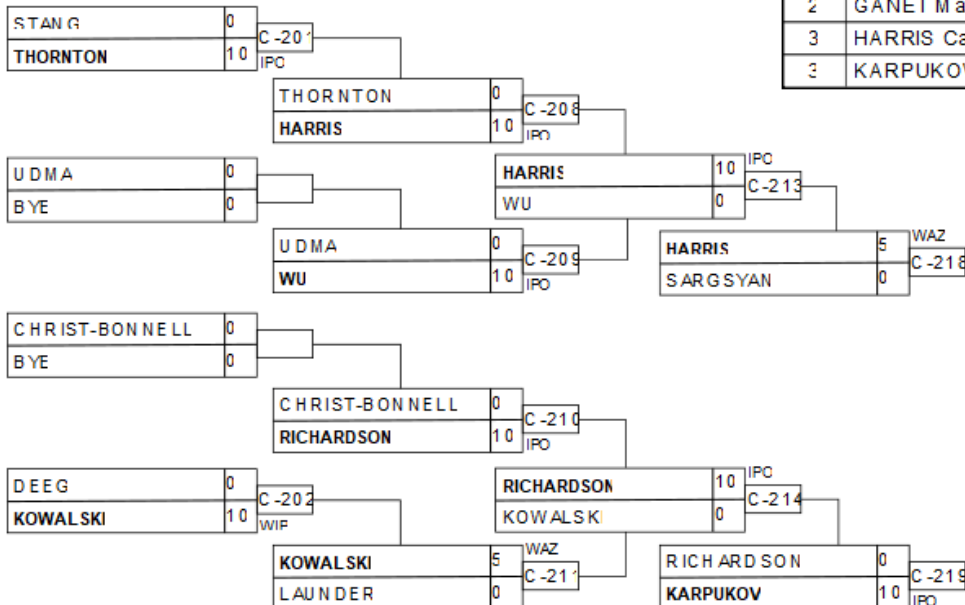

U21M -81 kg

Competitors/Compétiteurs A

#	Name/Nom	Club	1	2	3	4	W/G	Pts	Pos
1	PERRON Mathias	QC	XX	10	10		2	20	2
2	IVORY Eoin	AB		XX	10		1	10	3
3	GIESELMANN Josh	BC			XX		0	0	4
4	GUY Porter	ON	5	10	10	XX	3	25	1

Pool A

Match	White/Blanc		Blue/Bleu	Res/Rés	Tim/Tmp	Code	
D-211	PERRON Mathias	1	2	IVORY Eoin	10 - 0	1:45	WIP
D-212	GIESELMANN Josh	3	4	GUY Porter	0 - 10	1:54	IPO
D-215	PERRON Mathias	1	3	GIESELMANN Josh	10 - 0	0:43	IPO
D-216	IVORY Eoin	2	4	GUY Porter	0 - 10	0:27	IPO
D-219	PERRON Mathias	1	4	GUY Porter	0 - 5	4:00	WAZ
D-220	IVORY Eoin	2	3	GIESELMANN Josh	10 - 0	1:07	IPO

Competitors/Compétiteurs B

#	Name/Nom	Club	5	6	7	W/G	Pts	Pos
5	BERNS Mason	BC	XX			0	0	3
6	ALTHOUSE Carter	AB	10	XX	10	2	20	1
7	SOLOVEICHIK Binyamin	ON	10		XX	1	10	2

Pool B

Match	White/Blanc		Blue/Bleu	Res/Rés	Tim/Tmp	Code	
D-213	BERNS Mason	5	6	ALTHOUSE Carter	0 - 10	0:26	IPO
D-217	BERNS Mason	5	7	SOLOVEICHIK Binyamin	0 - 10	1:39	IPO
D-221	ALTHOUSE Carter	6	7	SOLOVEICHIK Binyamin	10 - 0	3:01	IPO

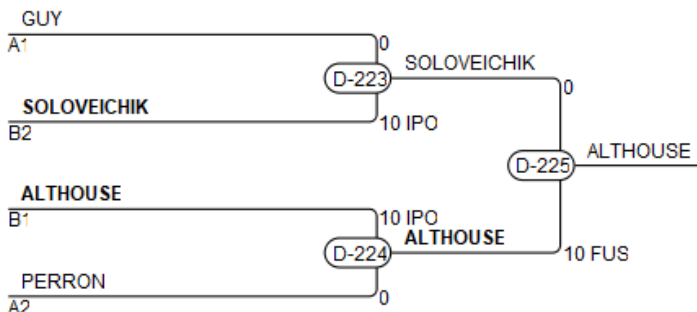

Results/Résultats

Pos	Name/Nom
1	ALTHOUSE Carter, AB
2	SOLOVEICHIK Binyamin, ON
3	GUY Porter, ON
3	PERRON Mathias, QC

U21M -90 kg

Competitors/Compétiteurs A

#	Name/Nom	Club	1	2	3	W/G	Pts	Pos
1	CRAEVOI Victor	AB	XX	10		1	10	2
2	SPRINKLE Millar	BC		XX		0	0	3
3	SOLOVEICHIK Yonatan	ON	10	10	XX	2	20	1

Pool A

Match	White/Blanc	Blue/Bleu	Res/Rés	Tim/Tmp	Code
A-193	CRAEVOI Victor 1 2	SPRINKLE Millar	10 - 0	0:09	IPO
A-201	CRAEVOI Victor 1 3	SOLOVEICHIK Yonatan	0 - 10	1:36	IPO
A-209	SPRINKLE Millar 2 3	SOLOVEICHIK Yonatan	0 - 10	0:10	IPO

Competitors/Compétiteurs B

#	Name/Nom	Club	4	5	6	W/G	Pts	Pos
4	GILL Gavann	AB	XX			0	0	3
5	PREVOST Hayden	BC	10	XX		1	10	2
6	NEWCOMEN Finn	BC	10	10	XX	2	20	1

Pool B

Match	White/Blanc	Blue/Bleu	Res/Rés	Tim/Tmp	Code
A-194	GILL Gavann 4 5	PREVOST Hayden	0 - 10	1:04	IPO
A-202	GILL Gavann 4 6	NEWCOMEN Finn	0 - 10	1:09	IPO
A-210	PREVOST Hayden 5 6	NEWCOMEN Finn	0 - 10	1:07	IPO

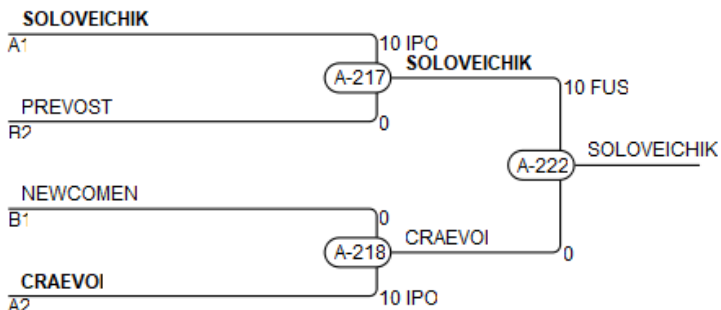

Results/Résultats

Pos	Name/Nom
1	SOLOVEICHIK Yonatan, ON
2	CRAEVOI Victor, AB
3	PREVOST Hayden, BC
3	NEWCOMEN Finn, BC

U21M +100 kg

Competitors/Compétiteurs

#	Name/Nom	Club	1	W/G	Pts	Pos
1	JAFARI-MINAB Ravi	BC	XX	0	0	1

Matches/Matches

Match	White/Blanc	Blue/Bleu	Res/Rés	Tim/Tmp	Code
-------	-------------	-----------	---------	---------	------

Results/Résultats

Pos	Name/Nom