

U16F -40kg 3k+

Compétiteurs/Competitors

#	Nom/Name	Grade	Club	1	G/W	Pts	Pos
1	MANAILA Nikole-Daria	3k	QC/lppon	XX	0	0	1

Matches/Matches

Match	Blanc/White	Bleu/Blue	Rés/Res	Tmp/Tim	Code
-------	-------------	-----------	---------	---------	------

Résultats/Results

Pos	Nom/Name

U16F -44kg 3k+

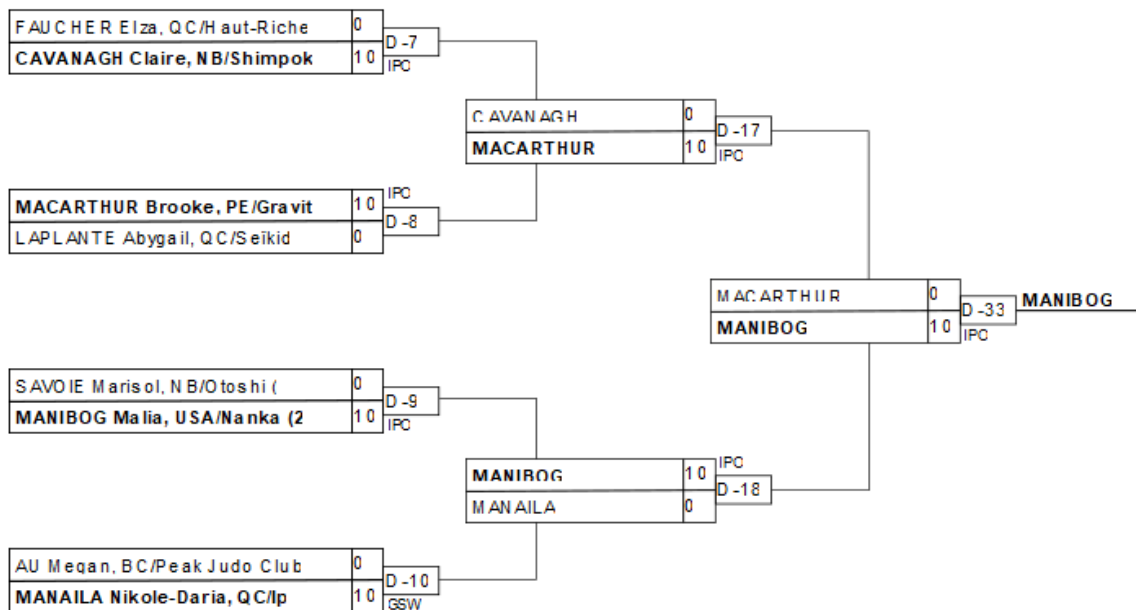

Résultats/Results

Pos	Nom/Name
1	MANIBOG Malia, USA/Nanka
2	MACARTHUR Brooke, PE/Gravit
3	SAVOIE Marisol, NB/Otoshi
3	MANAILA Nikole-Daria, QC

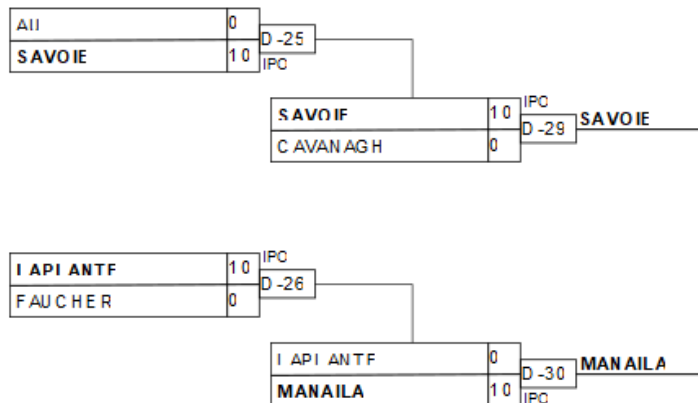

U16F -48kg 3k+

Compétiteurs/Competitors A

#	Nom/Name	Grade	Club	1	2	3	G/W	Pts	Pos
1	MINIER Annabel	3k	QC/St. Paul-l'Ermite	XX			0	0	3
2	LEWIS Kaylee	3k+	QC/Perrot Shima	10	XX		1	10	2
3	TAMURA Addyson	2k	AB/Lethbridge	10	10	XX	2	20	1

Pool A

Match	Blanc/White		Bleu/Blue	Rés/Res	Tmp/Tim	Code	
E-21	MINIER Annabel	1	2	LEWIS Kaylee	0 - 10	0:16	IPO
E-27	MINIER Annabel	1	3	TAMURA Addyson	0 - 10	1:12	IPO
E-31	LEWIS Kaylee	2	3	TAMURA Addyson	0 - 10	2:24	IPO

Compétiteurs/Competitors B

#	Nom/Name	Grade	Club	4	5	6	G/W	Pts	Pos
4	GROOTEN Maegan	3k	BC/Hart	XX		10	1	10	2
5	GRENIER Melody	2k	QC/Boucherville	10	XX	10	2	20	1
6	PELLETIER Chelsea	2k	NB/Kimo			XX	0	0	3

Pool B

Match	Blanc/White		Bleu/Blue	Rés/Res	Tmp/Tim	Code	
E-22	GROOTEN Maegan	4	5	GRENIER Melody	0 - 10	0:35	WIP
E-28	GROOTEN Maegan	4	6	PELLETIER Chelsea	10 - 0	0:09	IPO
E-32	GRENIER Melody	5	6	PELLETIER Chelsea	10 - 0	0:00	FUS

TAMURA

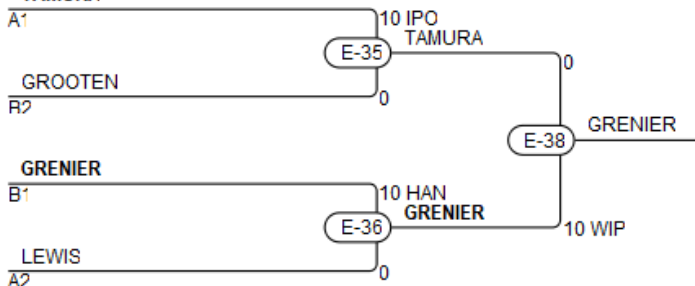

Résultats/Results

Pos	Nom/Name
1	GRENIER Melody, QC/Boucherville
2	TAMURA Addyson, AB/Lethbridge
3	GROOTEN Maegan, BC/Hart
3	LEWIS Kaylee, QC/Perrot Shima

U16F -52kg 3k+

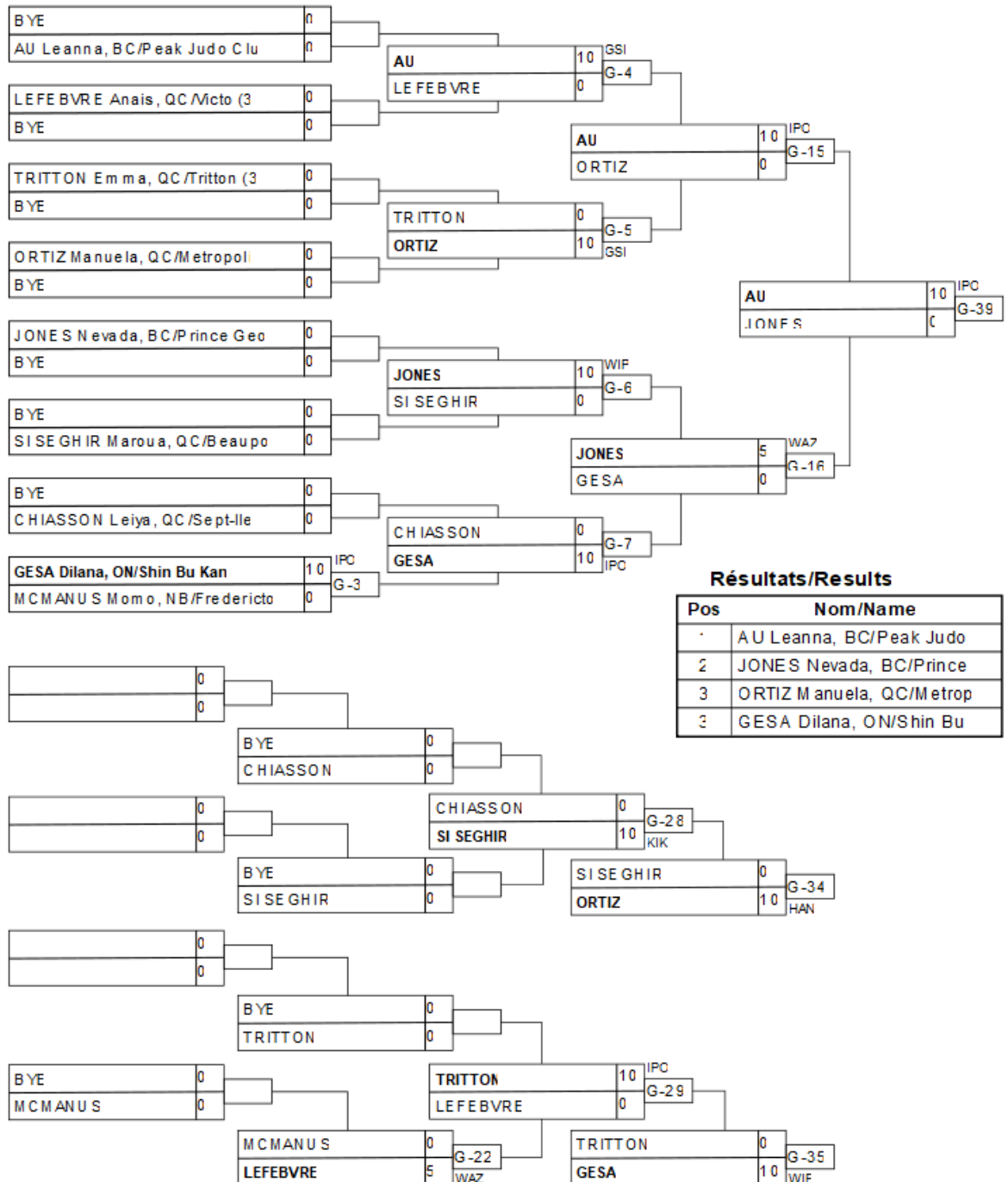

Résultats/Results

Pos	Nom/Name
1	AU Leanna, BC/Peak Judo
2	JONES Nevada, BC/Prince Geo
3	ORTIZ Manuela, QC/Metropol
3	GESA Dilana, ON/Shin Bu Kan

U16F -57kg 3k+

Compétiteurs/Competitors A

#	Nom/Name	Grade	Club	1	2	3	4	G/W	Pts	Pos
1	TSELIOS Diem	3k	QC/Olympique (Qc)	XX				0	0	4
2	OMMERT Emma	2k	ON/Ajax Budokan	10	XX	10		2	20	2
3	HUDSON Brooklyn	3k+	PE/Gravity Judo	10		XX		1	10	3
4	JOHNSTON Kaiya	2k	USA/Nanka	10	10	10	XX	3	30	1

Pool A

Match	Blanc/White			Bleu/Blue	Rés/Res	Tmp/Tim	Code
F-11	TSELIOS Diem	1	2	OMMERT Emma	0 - 10	0:32	IPO
F-12	HUDSON Brooklyn	3	4	JOHNSTON Kaiya	0 - 10	0:06	IPO
F-16	TSELIOS Diem	1	3	HUDSON Brooklyn	0 - 10	0:00	FUS
F-17	OMMERT Emma	2	4	JOHNSTON Kaiya	0 - 10	0:33	IPO
F-23	TSELIOS Diem	1	4	JOHNSTON Kaiya	0 - 10	0:00	FUS
F-24	OMMERT Emma	2	3	HUDSON Brooklyn	10 - 0	0:15	IPO

Compétiteurs/Competitors B

#	Nom/Name	Grade	Club	5	6	7	G/W	Pts	Pos
5	MACGRATH Keely	2k	PE/Tsuyoi	XX		5	1	5	2
6	WILSON Zoe	2k	NB/Shimpokai	10	XX	10	2	20	1
7	DEEG Annaka	3k	AB/Tokugawa			XX	0	0	3

Pool B

Match	Blanc/White			Bleu/Blue	Rés/Res	Tmp/Tim	Code
F-13	MACGRATH Keely	5	6	WILSON Zoe	0 - 10	0:32	IPO
F-18	MACGRATH Keely	5	7	DEEG Annaka	5 - 0	3:00	WAZ
F-25	WILSON Zoe	6	7	DEEG Annaka	10 - 0	2:01	IPO

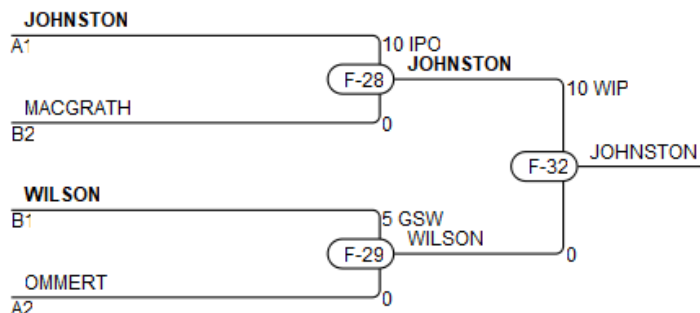

Résultats/Results

Pos	Nom/Name
1	JOHNSTON Kaiya, USA/Nanka
2	WILSON Zoe, NB/Shimpokai
3	MACGRATH Keely, PE/Tsuyoi
3	OMMERT Emma, ON/Ajax Budokan

U16F -63kg 3k+

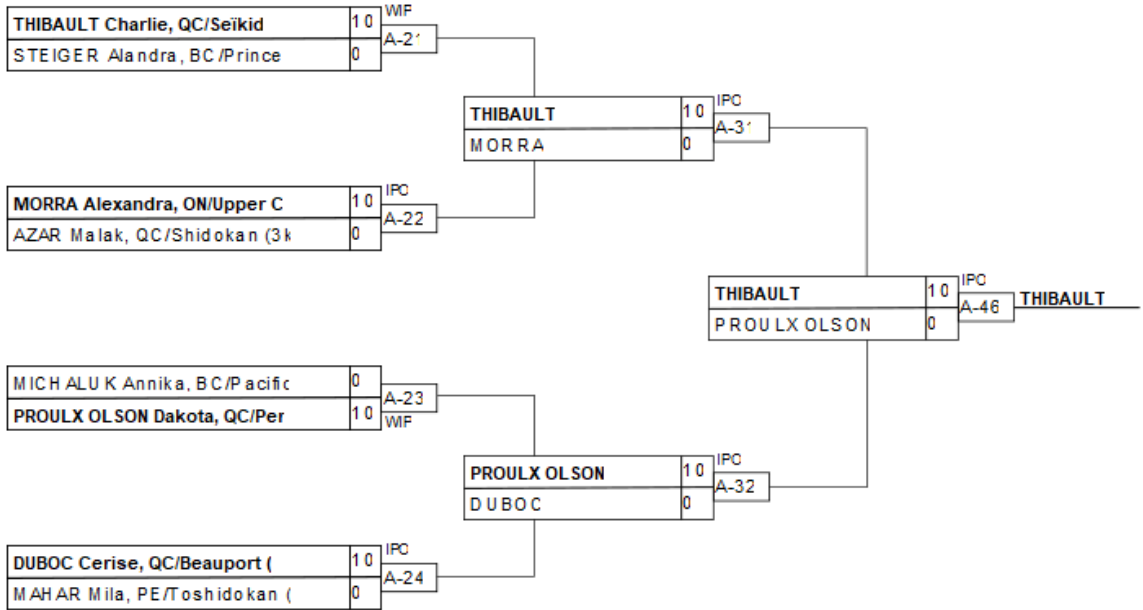

Résultats/Results

Pos	Nom/Name
1	THIBAULT Charlie, QC/Sei
2	PROULX OLSON Dakota, QC/
3	MORRA Alexandra, ON/Uppe
3	STEIGER Alandra, BC/P rin

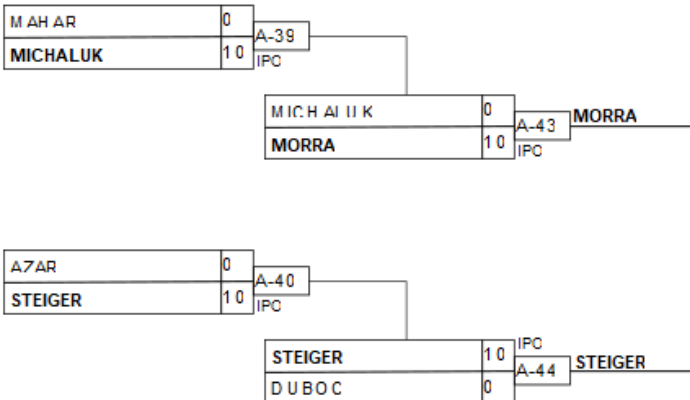

U16F -70kg 3k+

Compétiteurs/Competitors A

#	Nom/Name	Grade	Club	1	2	3	4	G/W	Pts	Pos
1	LAVOIE Abby	3k+	QC/Shawinigan	XX				0	0	4
2	DORVAL-MBELE Missy Jen	1k	QC/Metropolitain	10	XX	10	10	3	30	1
3	DEMETERCO Valentina	3k	BRA/Morguenau	10		XX	10	2	20	2
4	MCCULLOUGH Lily	2k	BC/Prince George	10			XX	1	10	3

Pool A

Match	Blanc/White			Bleu/Blue	Rés/Res	Tmp/Tim	Code
G-12	LAVOIE Abby	1	2	DORVAL-MBELE Missy Jen	0 - 10	0:27	IPO
G-13	DEMETERCO Valentina	3	4	MCCULLOUGH Lily	10 - 0	2:51	IPO
G-19	LAVOIE Abby	1	3	DEMETERCO Valentina	0 - 10	0:12	IPO
G-20	DORVAL-MBELE Missy Jen	2	4	MCCULLOUGH Lily	10 - 0	0:36	IPO
G-25	LAVOIE Abby	1	4	MCCULLOUGH Lily	0 - 10	0:13	IPO
G-26	DORVAL-MBELE Missy Jen	2	3	DEMETERCO Valentina	10 - 0	2:50	HAN

Compétiteurs/Competitors B

#	Nom/Name	Grade	Club	5	6	7	G/W	Pts	Pos
5	KITAEV Zulekha	3k	QC/Olympique (Qc)	XX			0	0	3
6	ALIYEVA Emiliya	2k	AB/Hiro's	10	XX		1	10	2
7	GROLEAU Beatrice	3k+	QC/Rouyn-Noranda	10	10	XX	2	20	1

Pool B

Match	Blanc/White			Bleu/Blue	Rés/Res	Tmp/Tim	Code
G-14	KITAEV Zulekha	5	6	ALIYEVA Emiliya	0 - 10	0:27	IPO
G-21	KITAEV Zulekha	5	7	GROLEAU Beatrice	0 - 10	0:31	WIP
G-27	ALIYEVA Emiliya	6	7	GROLEAU Beatrice	0 - 10	0:52	IPO

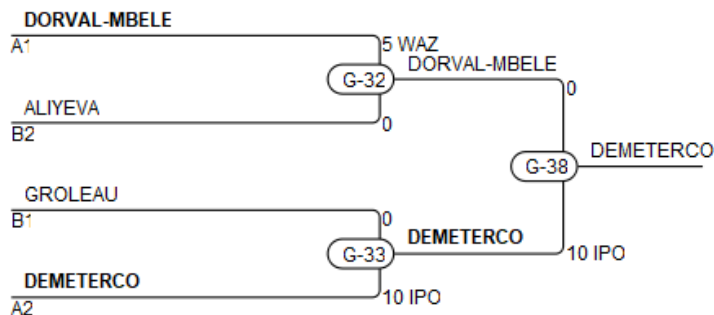

Résultats/Results

Pos	Nom/Name
1	DEMETERCO Valentina , BRA/Morguenau
2	DORVAL-MBELE Missy Jen, QC/Metropolitain
3	ALIYEVA Emiliya, AB/Hiro's
3	GROLEAU Beatrice, QC/Rouyn-Noranda

U16M -38kg 3k+

Compétiteurs/Competitors A

#	Nom/Name	Grade	Club	1	2	3	G/W	Pts	Pos
1	RODGERS Olivier	2k	QC/Sept-Iles	XX			0	0	3
2	MAHEUX William	1k	QC/Judo Beauce	10	XX		1	10	2
3	ABRAMOVICH David	3k	ON/Olympic	10	10	XX	2	20	1

Pool A

Match	Blanc/White			Bleu/Blue	Rés/Res	Tmp/Tim	Code
C-25	RODGERS Olivier	1	2	MAHEUX William	0 - 10	2:31	IPO
C-29	RODGERS Olivier	1	3	ABRAMOVICH David	0 - 10	0:43	WIP
C-35	MAHEUX William	2	3	ABRAMOVICH David	0 - 10	1:54	WIP

Compétiteurs/Competitors B

#	Nom/Name	Grade	Club	4	5	6	G/W	Pts	Pos
4	FIELD Ryan	3k	QC/Shidokan	XX		10	1	10	2
5	LI Alexander	3k	QC/Ippon	10	XX	10	2	20	1
6	LE BRIS Ewen	3k+	BC/Peak Judo Club			XX	0	0	3

Pool B

Match	Blanc/White			Bleu/Blue	Rés/Res	Tmp/Tim	Code
C-26	FIELD Ryan	4	5	LI Alexander	0 - 10	2:09	IPO
C-30	FIELD Ryan	4	6	LE BRIS Ewen	10 - 0	1:03	IPO
C-36	LI Alexander	5	6	LE BRIS Ewen	10 - 0	4:55	GSI

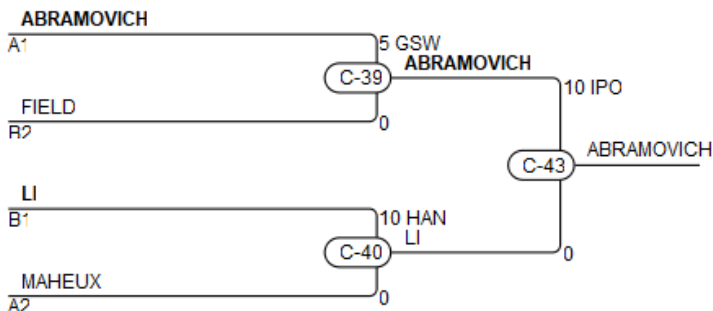

Résultats/Results

Pos	Nom/Name
1	ABRAMOVICH David, ON/Olympic
2	LI Alexander, QC/Ippon
3	FIELD Ryan, QC/Shidokan
3	MAHEUX William, QC/Judo Beauce

U16M -42kg 3k+

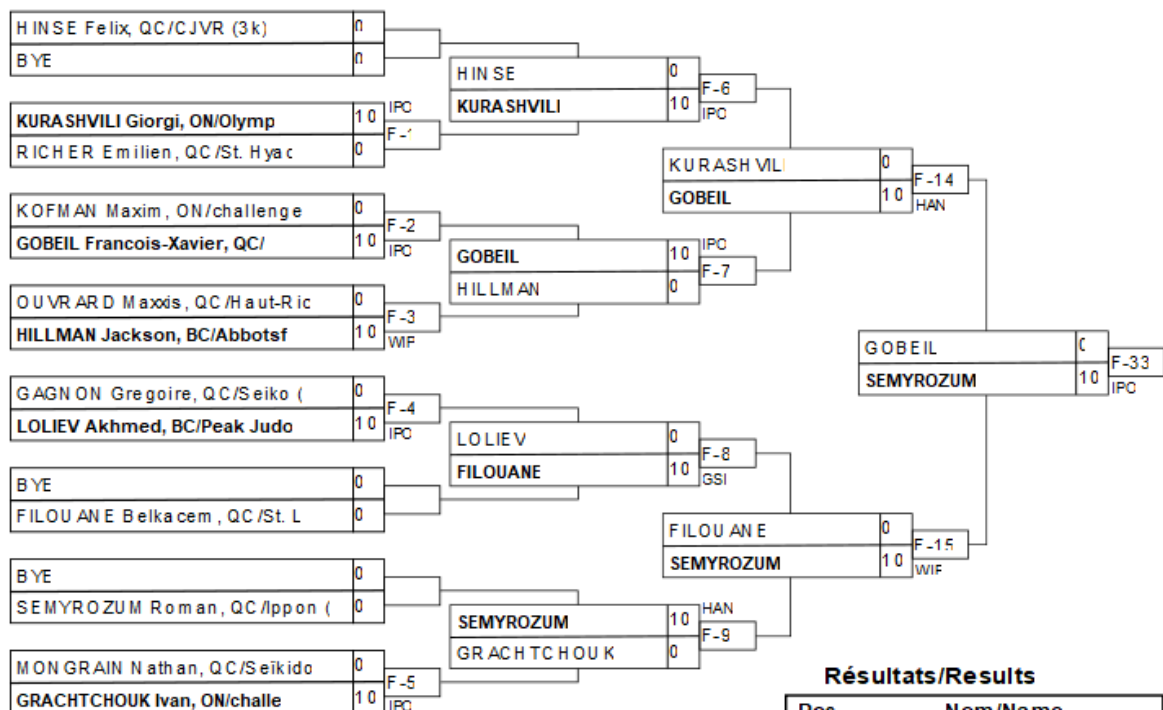

Résultats/Results

Pos	Nom/Name
1	SEMYROZUM Roman, QC/Ippon
2	GOBEIL Francois-Xavier,
3	KURASHVILI Giorgi, ON/OI
3	FILOUANE Belkacem, QC/St

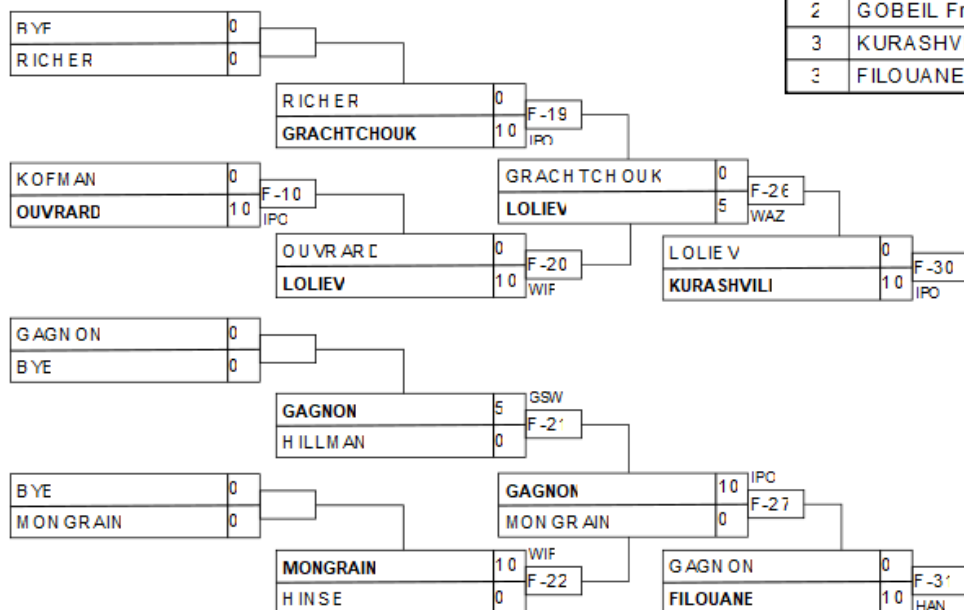

U16M -46kg 3k+

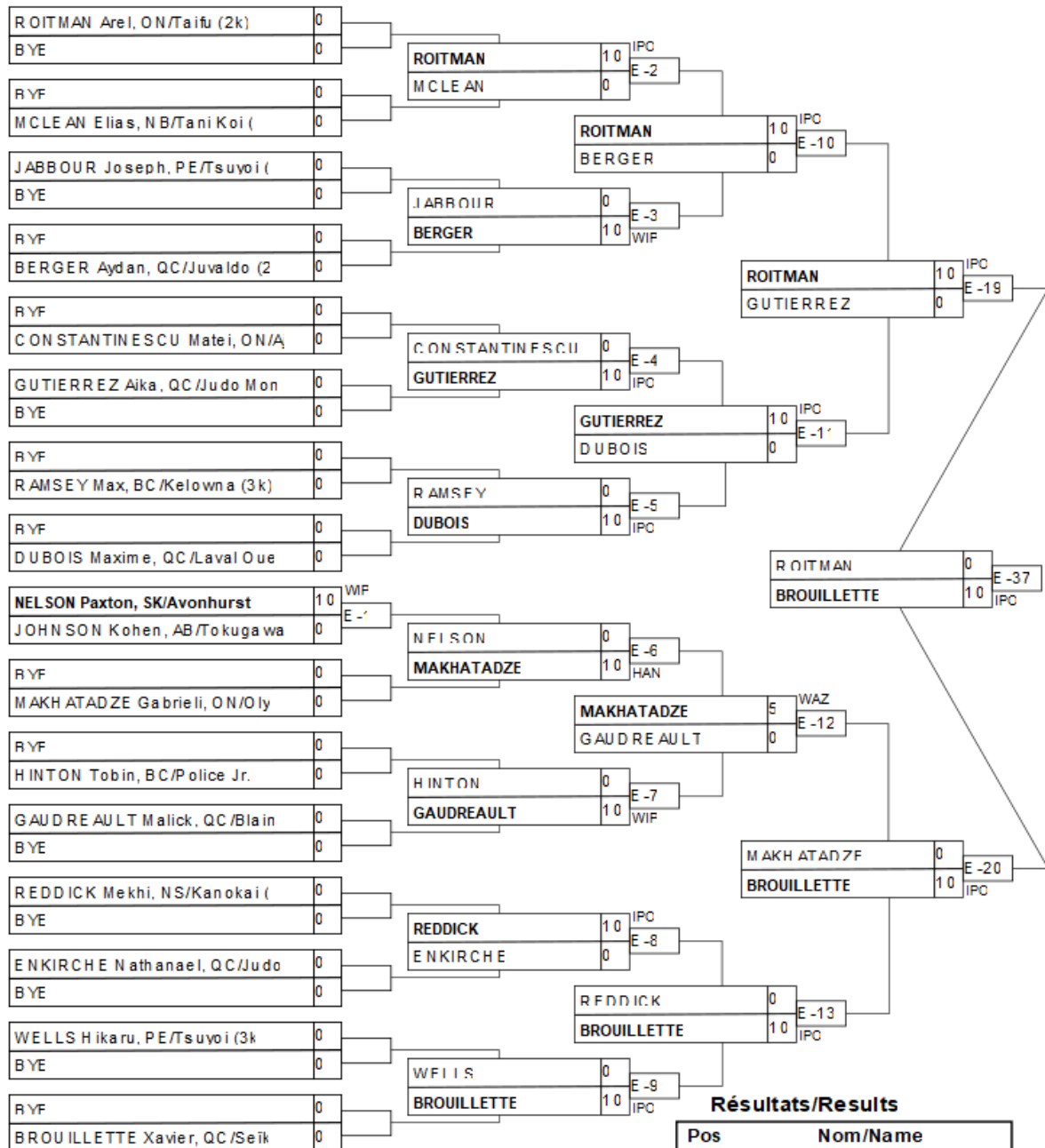

Résultats/Results

Pos	Nom/Name
1	BROUILLETTE Xavier, QC/S
2	ROITMAN Arel, ON/Taifu (
3	GAUDREAU Malick, QC/BI
4	HINTON Tobin, BC/Police

U16M -50kg 3k+

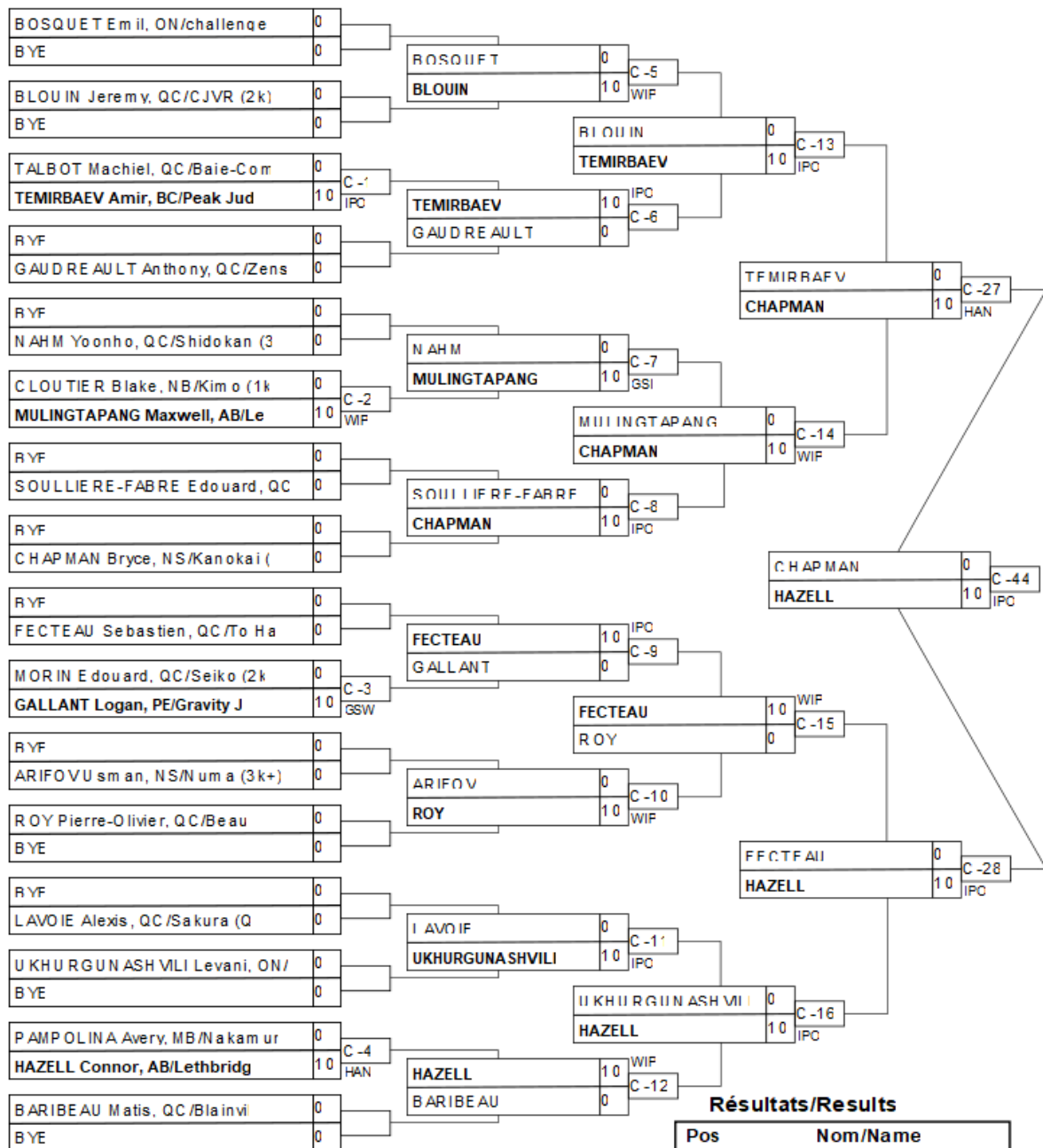

Résultats/Results

Pos	Nom/Name
1	HAZELL Connor, AB/Lethbr
2	CHAPMAN Bryce, NS/Kanoka
3	TEMIRBAEV Amir, BC/Peak
3	PAMPOLINA Avery, MB/Naka

U16M -55kg 3k+

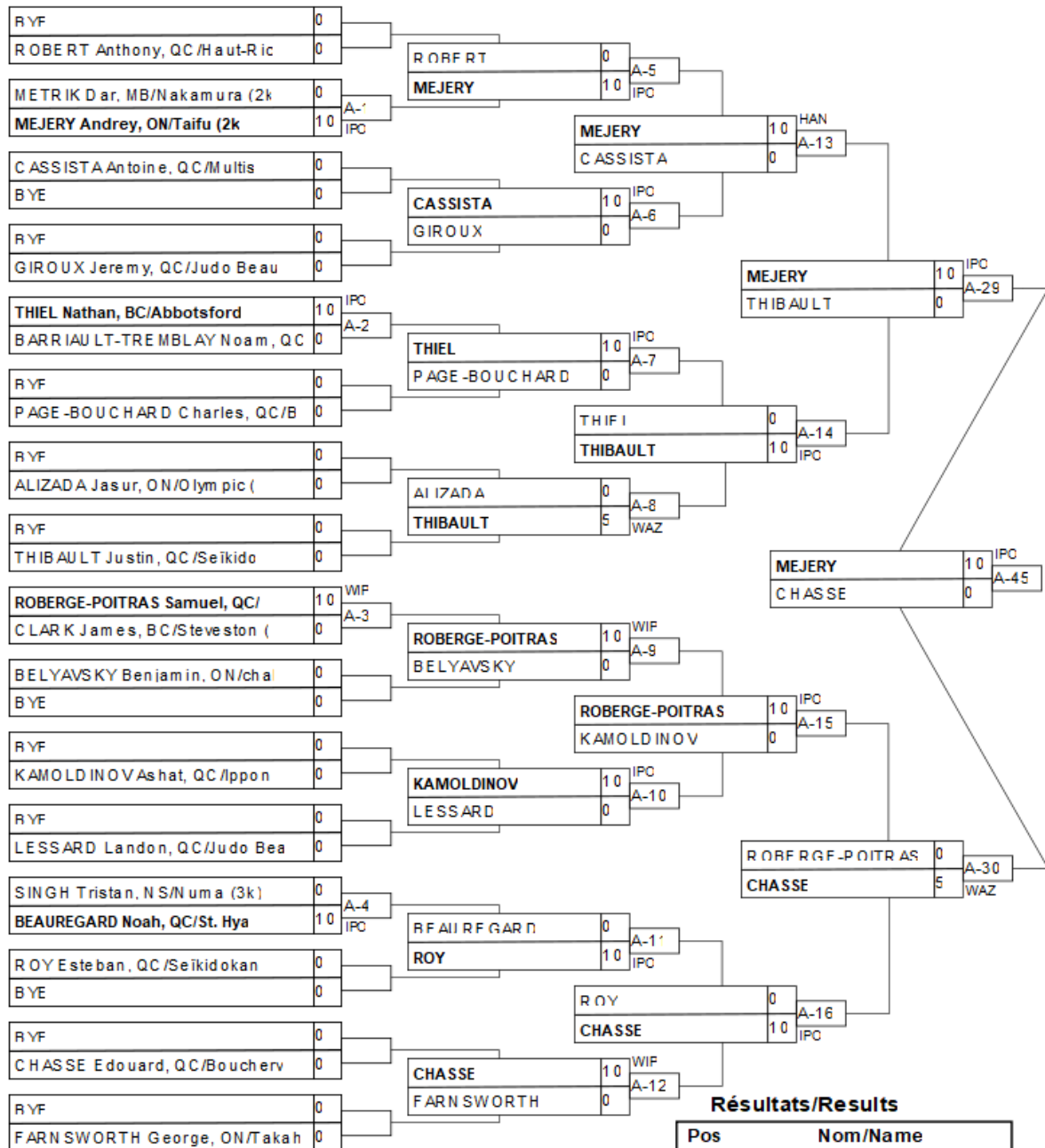

Résultats/Results

Pos	Nom/Name
1	MEJERY Andrey, ON/Taifu
2	CHASSE Edouard, QC/Bouch
3	THIBAUT Justin, QC/Seik
4	FARNSWORTH George, ON/Takah

U16M -60kg 3k+

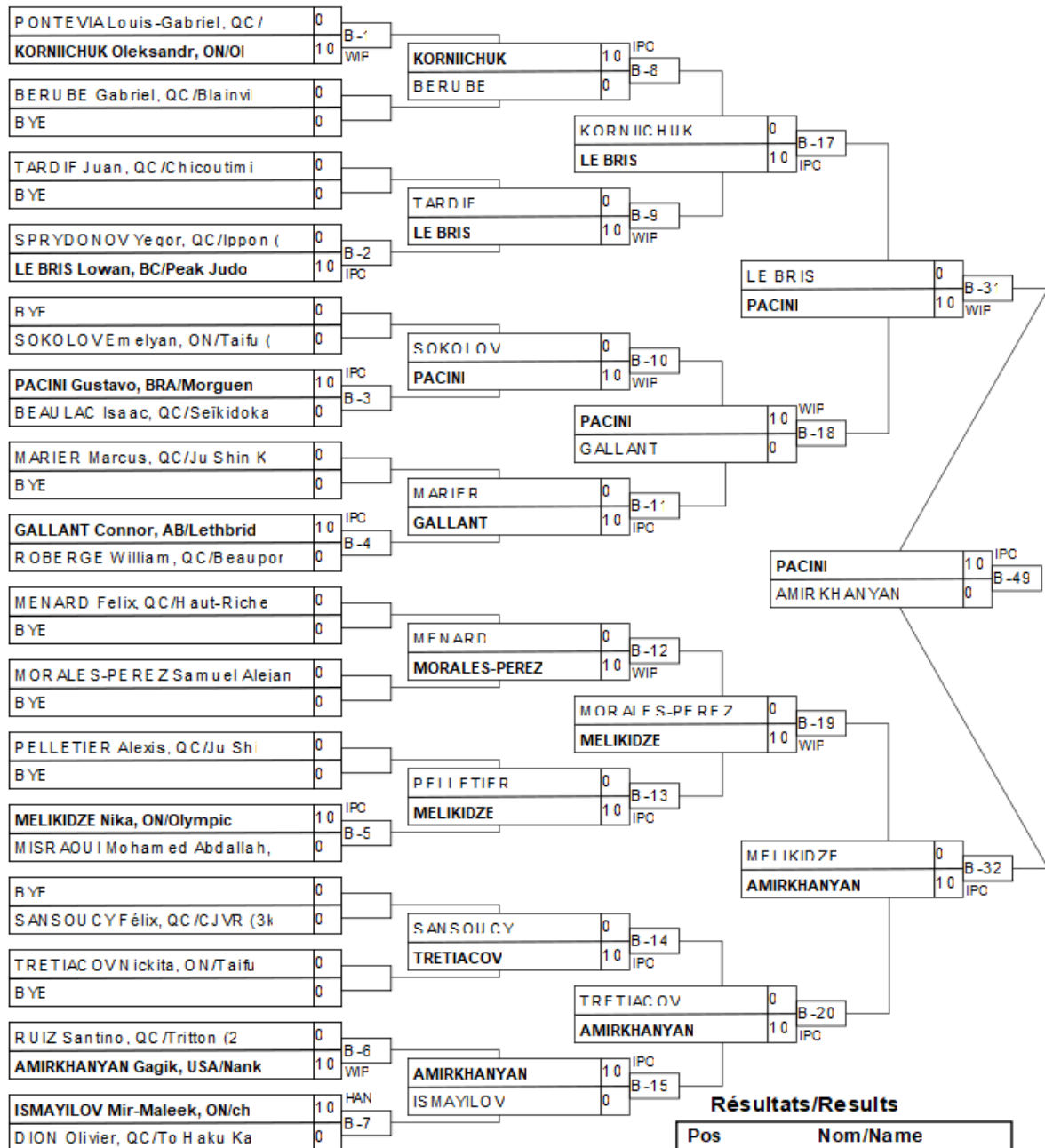

Résultats/Results

Pos	Nom/Name
1	PACINI Gustavo, BRA/Morg
2	AMIRKHANYAN Gagik, USA/N
3	LE BRIS Lowan, BC/Peak J
4	KORNIICHUK O Aleksandr, ON

U16M -66kg 3k+

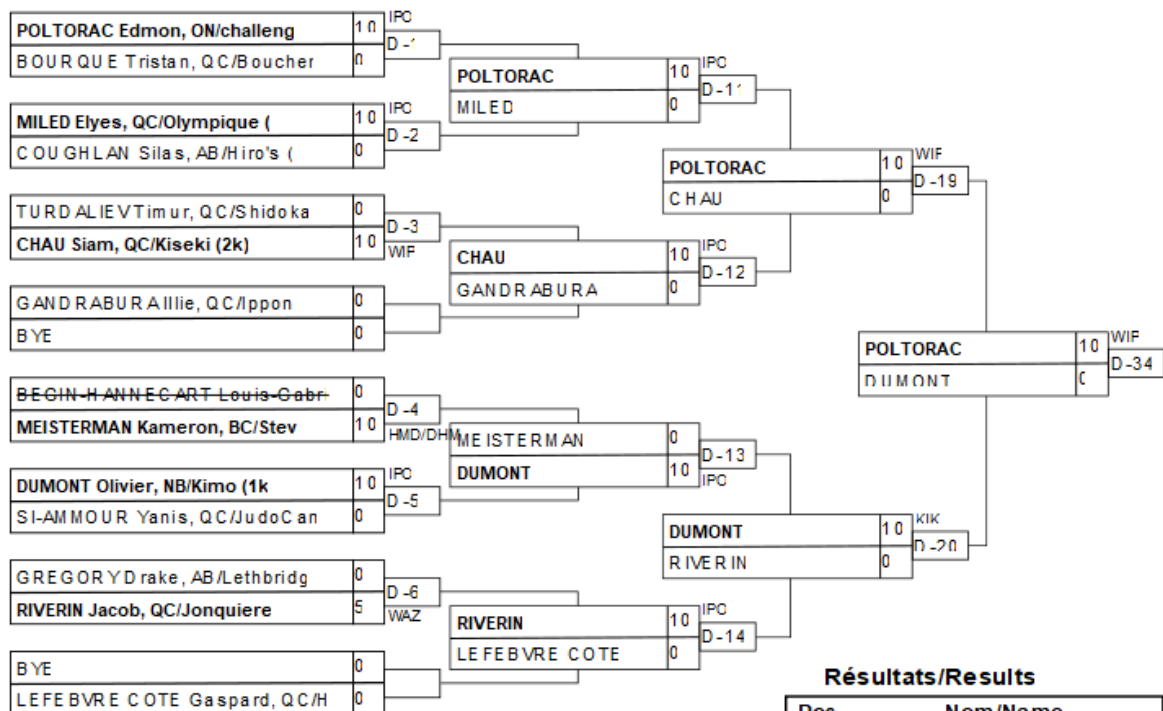

Résultats/Results

Pos	Nom/Name
1	POLTORAC Edmon, ON/chall
2	DUMONT Olivier, NB/Kimo
3	BOURQUE Tristan, QC/Bouc
3	RIVERIN Jacob, QC/Jonqui

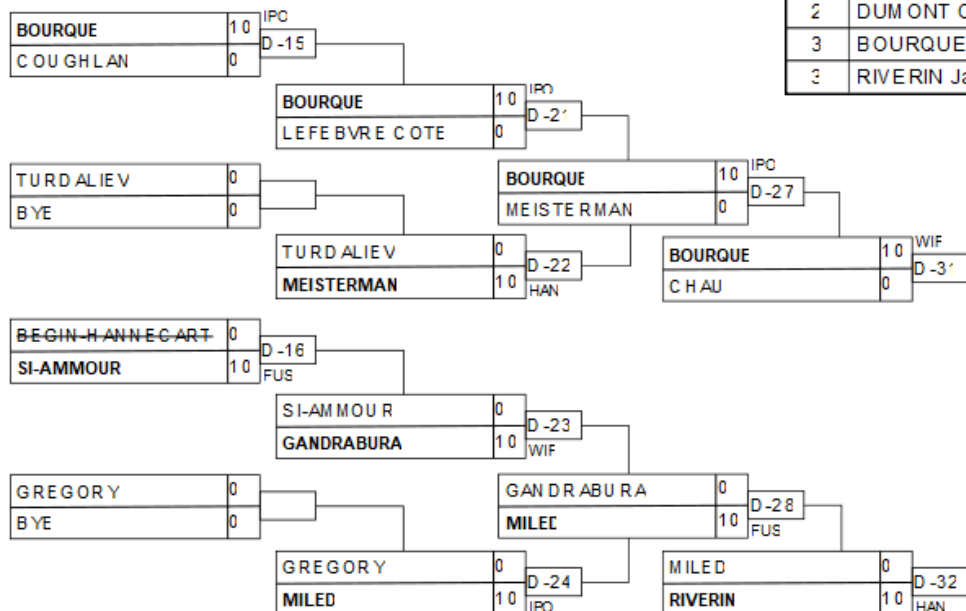

U16M -73kg 3k+

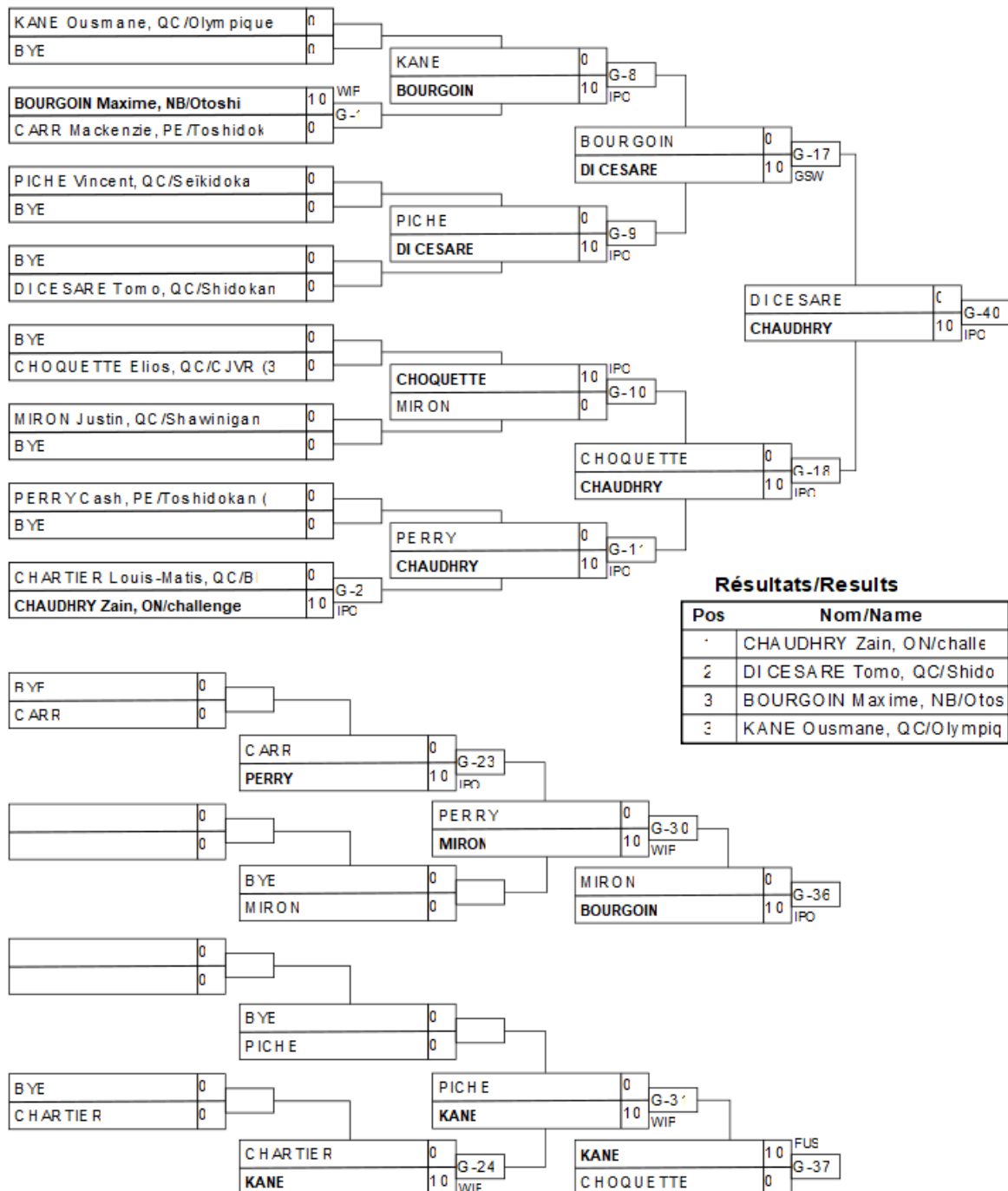

Résultats/Results

Pos	Nom/Name
1	CHAUDHRY Zain, ON/challe
2	DI CESARE Tomo, QC/Shido
3	BOURGOIN Maxime, NB/Otos
3	KANE Ousmane, QC/Olympi

U16M 73kg 3k+

Compétiteurs/Competitors A

#	Nom/Name	Grade	Club	1	2	3	G/W	Pts	Pos
1	L'ESPERANCE Kaleb	2k	QC/Blainville	XX		10	1	10	2
2	UEYAMA Kanta	2k+	USA/Nanka	10	XX	10	2	20	1
3	ROY Louis-Philip	3k	QC/Univestrie/Donini			XX	0	0	3

Pool A

Match	Blanc/White		Bleu/Blue	Rés/Res	Tmp/Tim	Code	
B-33	L'ESPERANCE Kaleb	1	2	UEYAMA Kanta	0 - 10	1:05	WIP
B-39	L'ESPERANCE Kaleb	1	3	ROY Louis-Philip	10 - 0	2:06	IPO
B-43	UEYAMA Kanta	2	3	ROY Louis-Philip	10 - 0	0:06	IPO

Compétiteurs/Competitors B

#	Nom/Name	Grade	Club	4	5	6	G/W	Pts	Pos
4	FORTIN Olivier	2k	QC/Sakura (QC)	XX	10		1	10	2
5	MAHEUX-DYER Andrew	2k	QC/Beauport		XX		0	0	3
6	BATBAYAR Munkhu	2k	AB/Lethbridge	10	10	XX	2	20	1

Pool B

Match	Blanc/White		Bleu/Blue	Rés/Res	Tmp/Tim	Code	
B-34	FORTIN Olivier	4	5	MAHEUX-DYER Andrew	10 - 0	1:13	IPO
B-40	FORTIN Olivier	4	6	BATBAYAR Munkhu	0 - 10	2:08	IPO
B-44	MAHEUX-DYER Andrew	5	6	BATBAYAR Munkhu	0 - 10	0:25	WIP

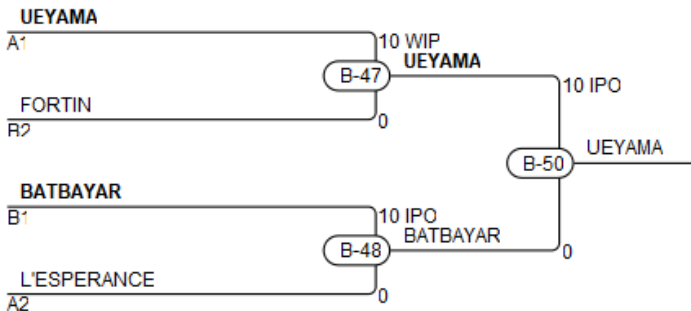

Résultats/Results

Pos	Nom/Name
1	UEYAMA Kanta, USA/Nanka
2	BATBAYAR Munkhu, AB/Lethbridge
3	FORTIN Olivier, QC/Sakura (QC)
3	L'ESPERANCE Kaleb, QC/Blainville

SENF -48kg 1k+

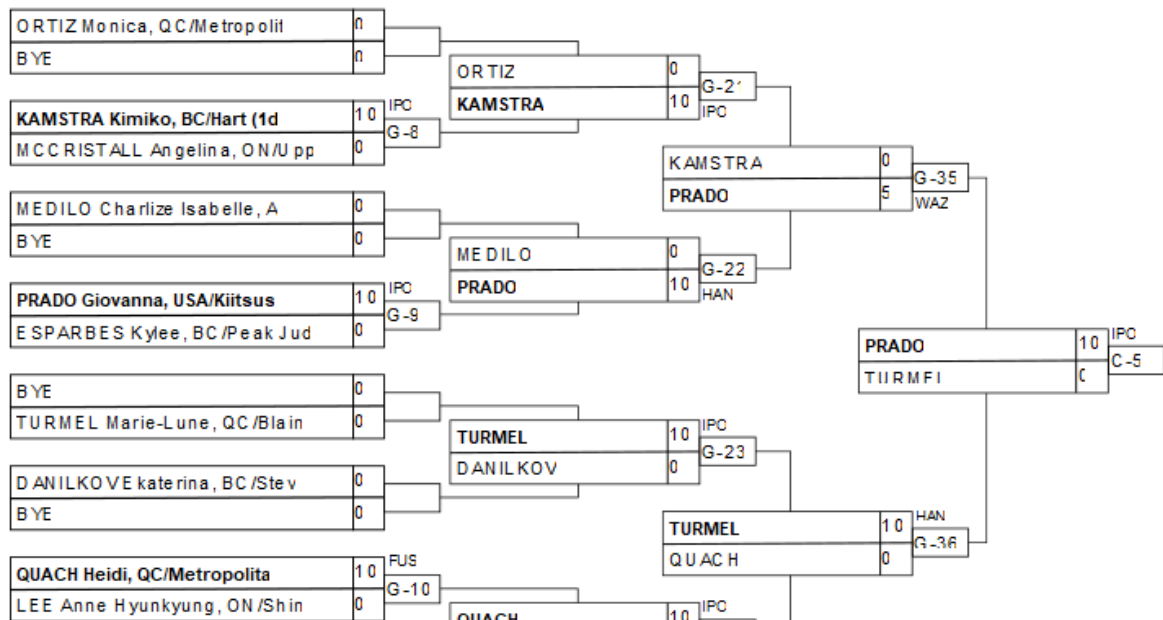

Résultats/Results

Pos	Nom/Name
1	PRADO Giovanna, USA/Kiit
2	TURMEL Marie-Lune, QC/BI
3	DANILKOV E katerina, BC/S
3	MEDILO Charliz e Isabelle

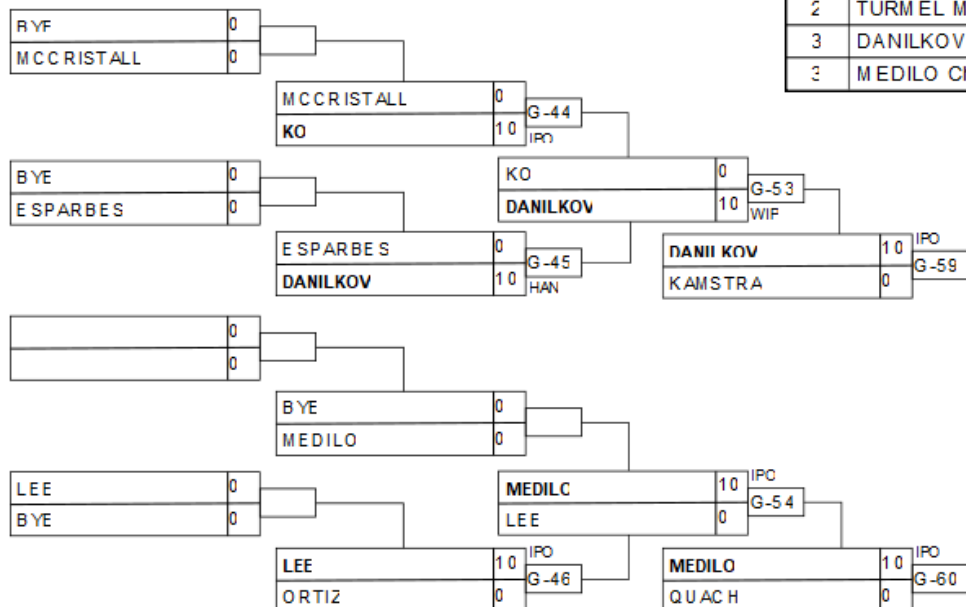

SENF -52kg 1k+

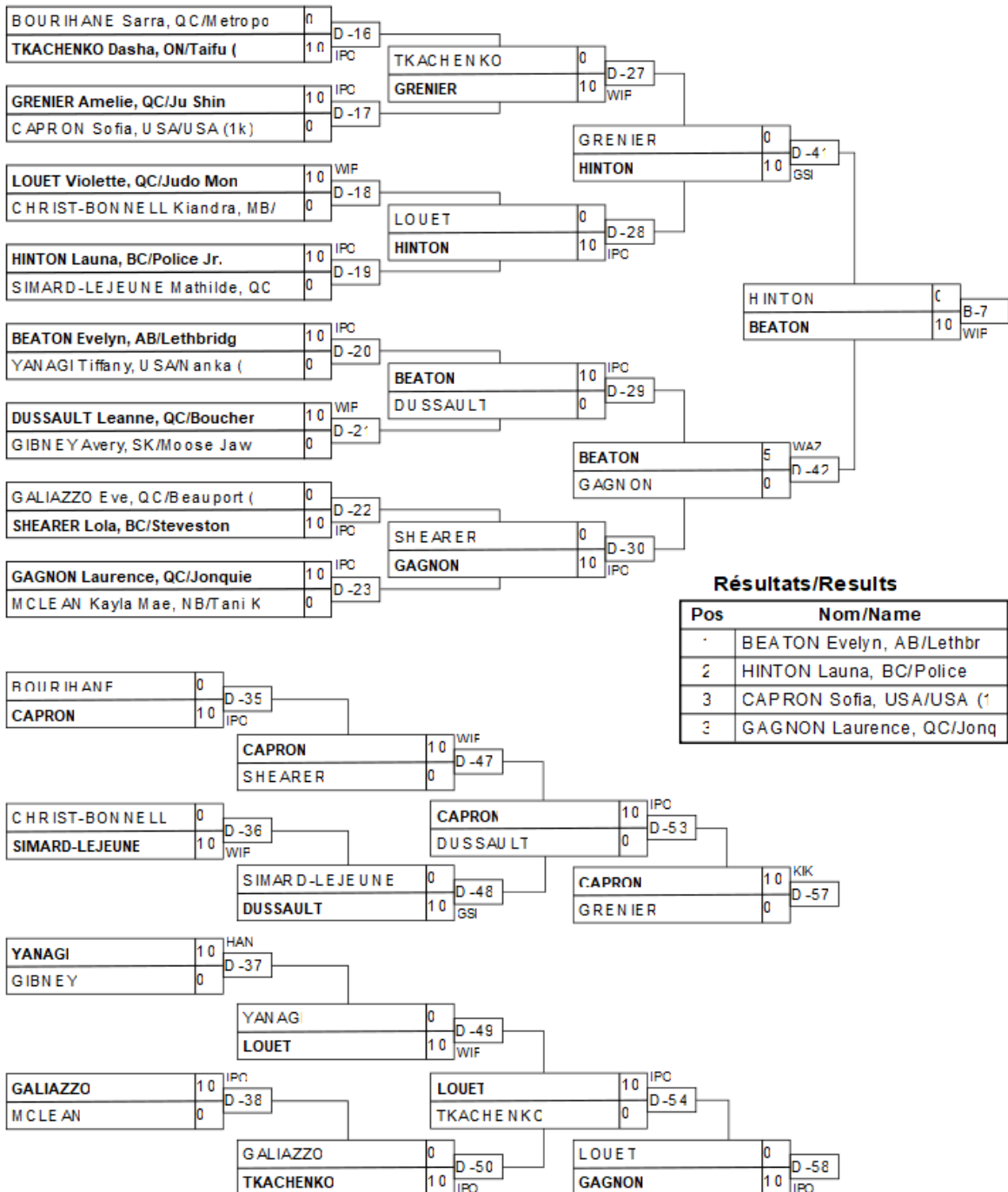

Résultats/Results

Pos	Nom/Name
1	BEATON Evelyn, AB/Lethbr
2	HINTON Launa, BC/Police
3	CAPRON Sofia, USA/USA (1)
3	GAGNON Laurence, QC/Jonq

SENF -57kg 1k+

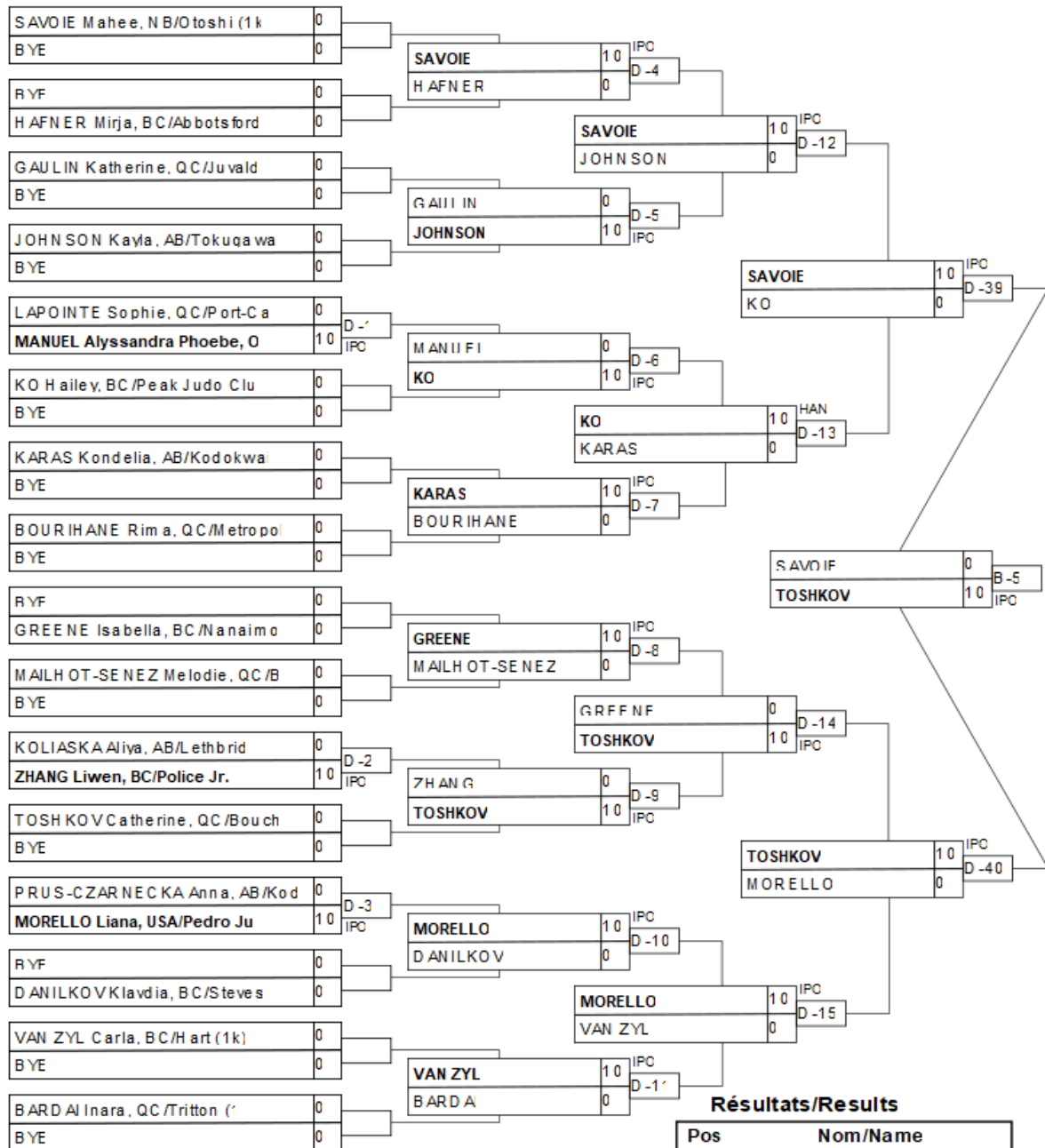

Résultats/Results

Pos	Nom/Name
1	TOSHKOV Catherine, QC/Bouch
2	SAVOIE Mahee, NB/Otoshi
3	KO Hailey, BC/Peak Judo
4	KOLIASKA Aliya, AB/Lethbr

SENF -63kg 1k+

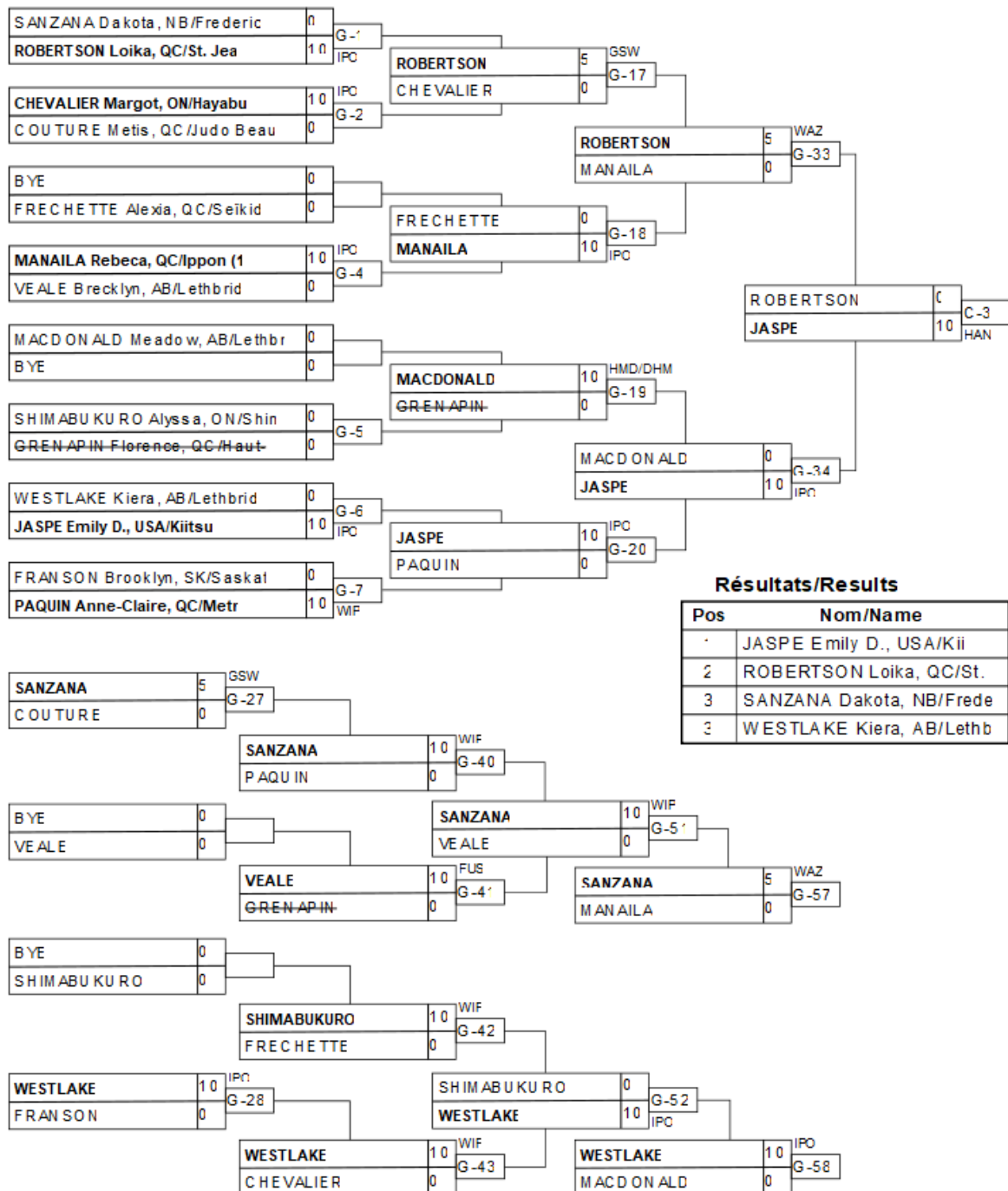

Résultats/Results

Pos	Nom/Name
1	JASPE Emily D., USA/Kiitsu
2	ROBERTSON Loika, QC/St.
3	SANZANA Dakota, NB/Frede
3	WESTLAKE Kiera, AB/Lethb

SENF -70kg 1k+

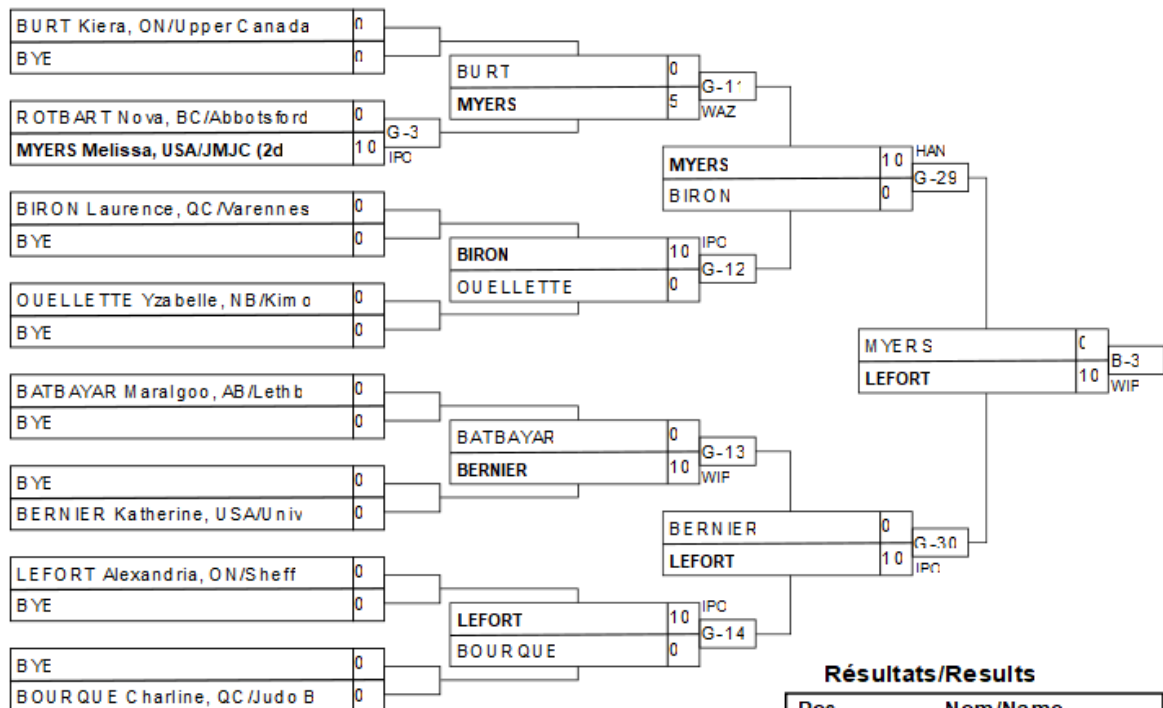

Résultats/Results

Pos	Nom/Name
1	LEFORT Alexandria, ON/Sh
2	MYERS Melissa, USA/JMJC
3	BIRON Laurence, QC/Varen
3	BURT Kiera, ON/Upper Can

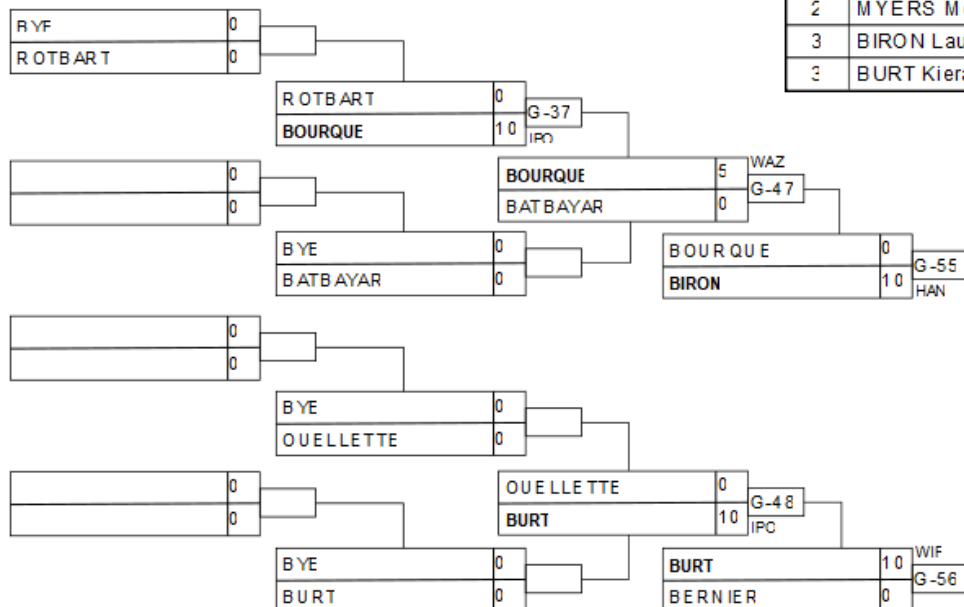

SENF -78kg 1k+

Compétiteurs/Competitors A

#	Nom/Name	Grade	Club	1	2	3	G/W	Pts	Pos
1	SOLIS Madeline	1k	USA/Eastside dojo	XX			0	0	3
2	COULOMBE Mina	3d	QC/Baie-Comeau	10	XX	10	2	20	1
3	LAVIGNE Frederique	1k	QC/Metropolitain	10		XX	1	10	2

Pool A

Match	Blanc/White	Bleu/Blue	Rés/Res	Tmp/Tim	Code
E-37	SOLIS Madeline 1 2	COULOMBE Mina	0 - 10	1:38	IPO
E-45	SOLIS Madeline 1 3	LAVIGNE Frederique	0 - 10	1:41	IPO
E-53	COULOMBE Mina 2 3	LAVIGNE Frederique	10 - 0	0:47	IPO

Compétiteurs/Competitors B

#	Nom/Name	Grade	Club	4	5	6	G/W	Pts	Pos
4	ALAYNICK Jessica	1k	USA/JMJC	XX		10	1	10	2
5	GODBOUT Coralie	1d	QC/Kiseki	10	XX	10	2	20	1
6	FOWLER Naomi	1k	NB/Tani Koi			XX	0	0	3

Pool B

Match	Blanc/White	Bleu/Blue	Rés/Res	Tmp/Tim	Code
E-38	ALAYNICK Jessica 4 5	GODBOUT Coralie	0 - 10	0:13	IPO
E-46	ALAYNICK Jessica 4 6	FOWLER Naomi	10 - 0	0:09	IPO
E-54	GODBOUT Coralie 5 6	FOWLER Naomi	10 - 0	0:15	IPO

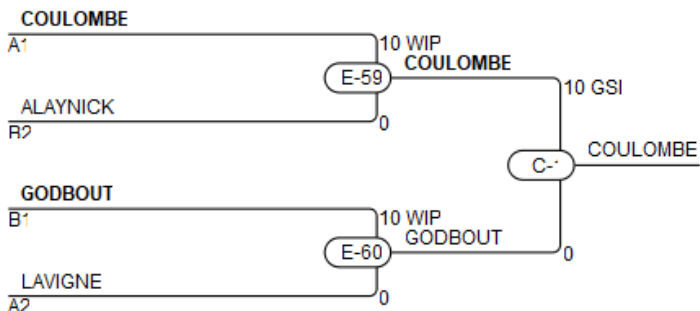

Résultats/Results

Pos	Nom/Name
1	COULOMBE Mina, QC/Baie-Comeau
2	GODBOUT Coralie, QC/Kiseki
3	ALAYNICK Jessica, USA/JMJC
3	LAVIGNE Frederique, QC/Metropolitain

SENF +78kg 1k+

Compétiteurs/Competitors

#	Nom/Name	Grade	Club	1	2	3	4	5	G/W	Pts	Pos
1	MCALPINE Amanda	1d	ON/Full Circle	XX		10		10	2	20	3
2	LINGLEY Brandi	1k	NB/Tani Koi	10	XX	10		10	3	30	2
3	BISSON Charlie	1k	QC/Charlesbourg			XX			0	0	5
4	PORTUONDO-ISASI Adriana	1d	QC/Boucherville	10	10	10	XX	10	4	40	1
5	DESBIENS Sara	1d	QC/Ju Shin Kan			10		XX	1	10	4

Matches/Matches

Match	Blanc/White			Bleu/Blue	Rés/Res	Tmp/Tim	Code
G-15	PORTUONDO-ISASI Adriana	4	5	DESBIENS Sara	10 - 0	0:55	IPO
G-16	MCALPINE Amanda	1	2	LINGLEY Brandi	0 - 10	1:07	WIP
G-25	BISSON Charlie	3	4	PORTUONDO-ISASI Adriana	0 - 10	0:05	IPO
G-26	MCALPINE Amanda	1	5	DESBIENS Sara	10 - 0	3:15	IPO
G-31	LINGLEY Brandi	2	3	BISSON Charlie	10 - 0	1:53	IPO
G-32	MCALPINE Amanda	1	4	PORTUONDO-ISASI Adriana	0 - 10	0:41	WIP
G-38	BISSON Charlie	3	5	DESBIENS Sara	0 - 10	0:00	FUS
G-39	LINGLEY Brandi	2	4	PORTUONDO-ISASI Adriana	0 - 10	0:32	IPO
G-49	MCALPINE Amanda	1	3	BISSON Charlie	10 - 0	0:00	FUS
G-50	LINGLEY Brandi	2	5	DESBIENS Sara	10 - 0	3:04	WIP

Résultats/Results

Pos	Nom/Name
1	PORTUONDO-ISASI Adriana, QC/Boucherville
2	LINGLEY Brandi, NB/Tani Koi
3	MCALPINE Amanda, ON/Full Circle
4	DESBIENS Sara, QC/Ju Shin Kan

SENM -100kg 1k+

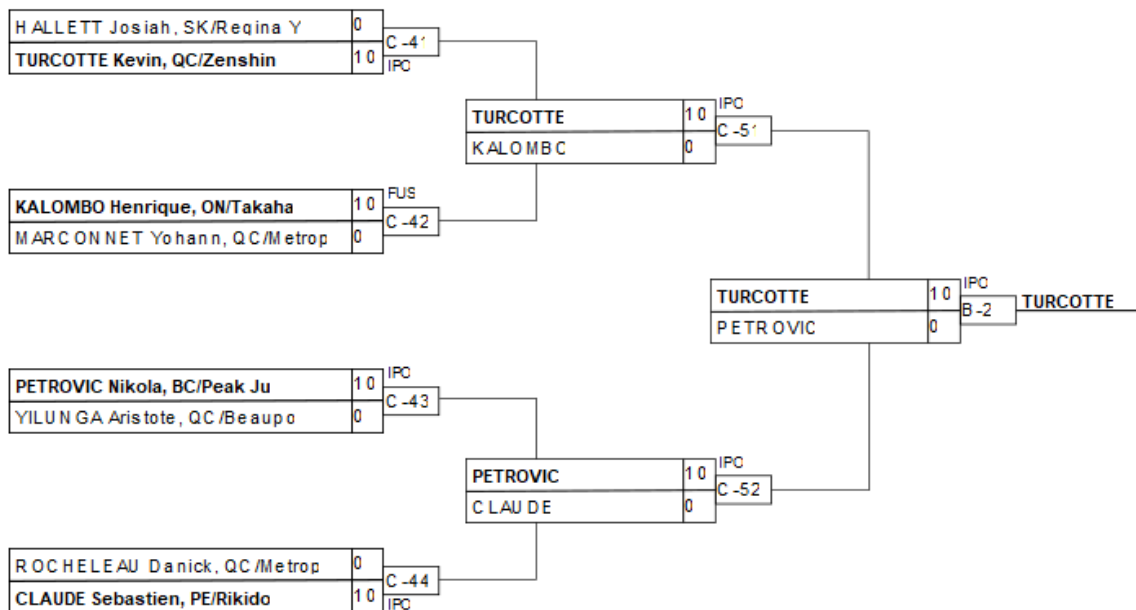

Résultats/Results

Pos	Nom/Name
1	TURCOTTE Kevin, QC/Zenshin
2	PETROVIC Nikola, BC/Peak
3	KALOMBO Henrique, ON/Tak
3	CLAUDE Sebastien, PE/Rik

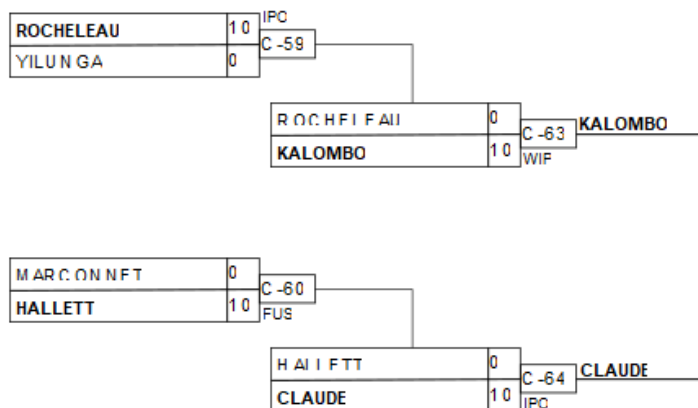

SENM -60kg 1k+

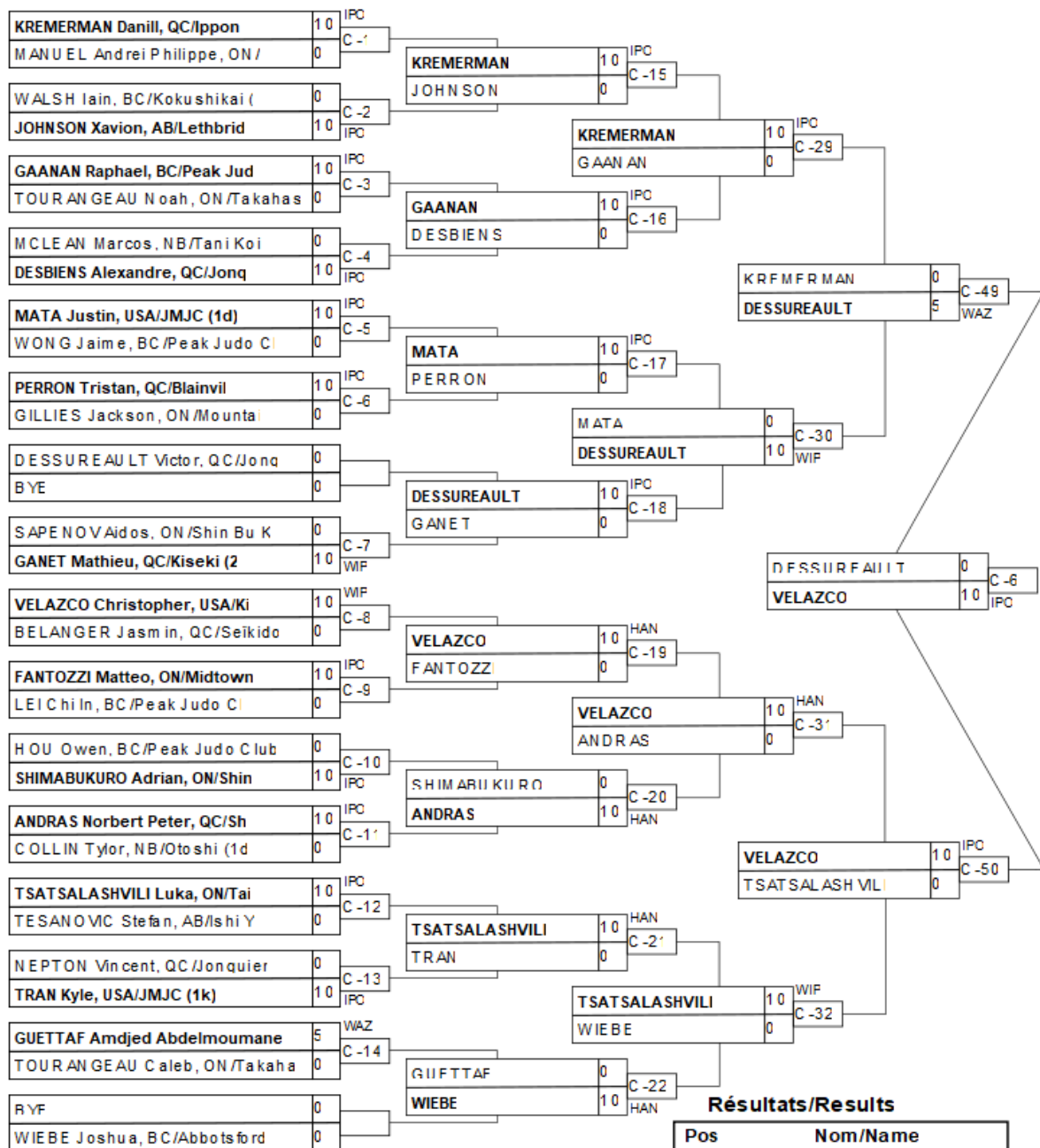

Résultats/Results

Pos	Nom/Name
1	VELAZCO Christopher, USA
2	DESSUREAULT Victor, QC/J
3	ANDRAS Norbert Peter, QC
4	TSATSALASHVILI Luka, ON/

SENM -66kg 1k+

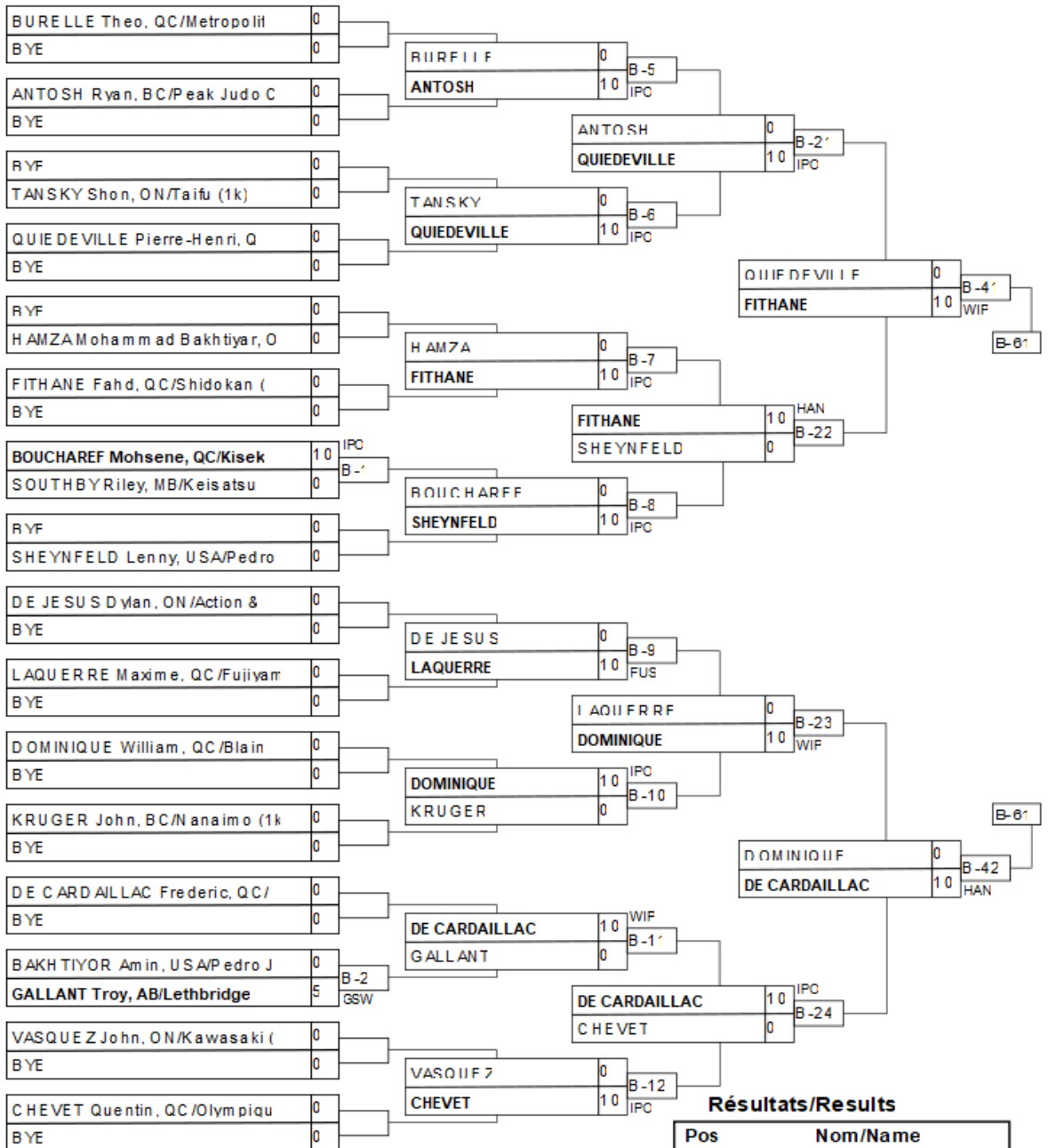

Résultats/Results

Pos	Nom/Name
1	DE CARDAILLAC Frederic,
2	PELLETIER Malcolm, QC/Tr
3	BAKHTIYOR Amin, USA/Pedro
3	FITHANE Fahd, QC/Shidoka

SENM -73kg 1k+

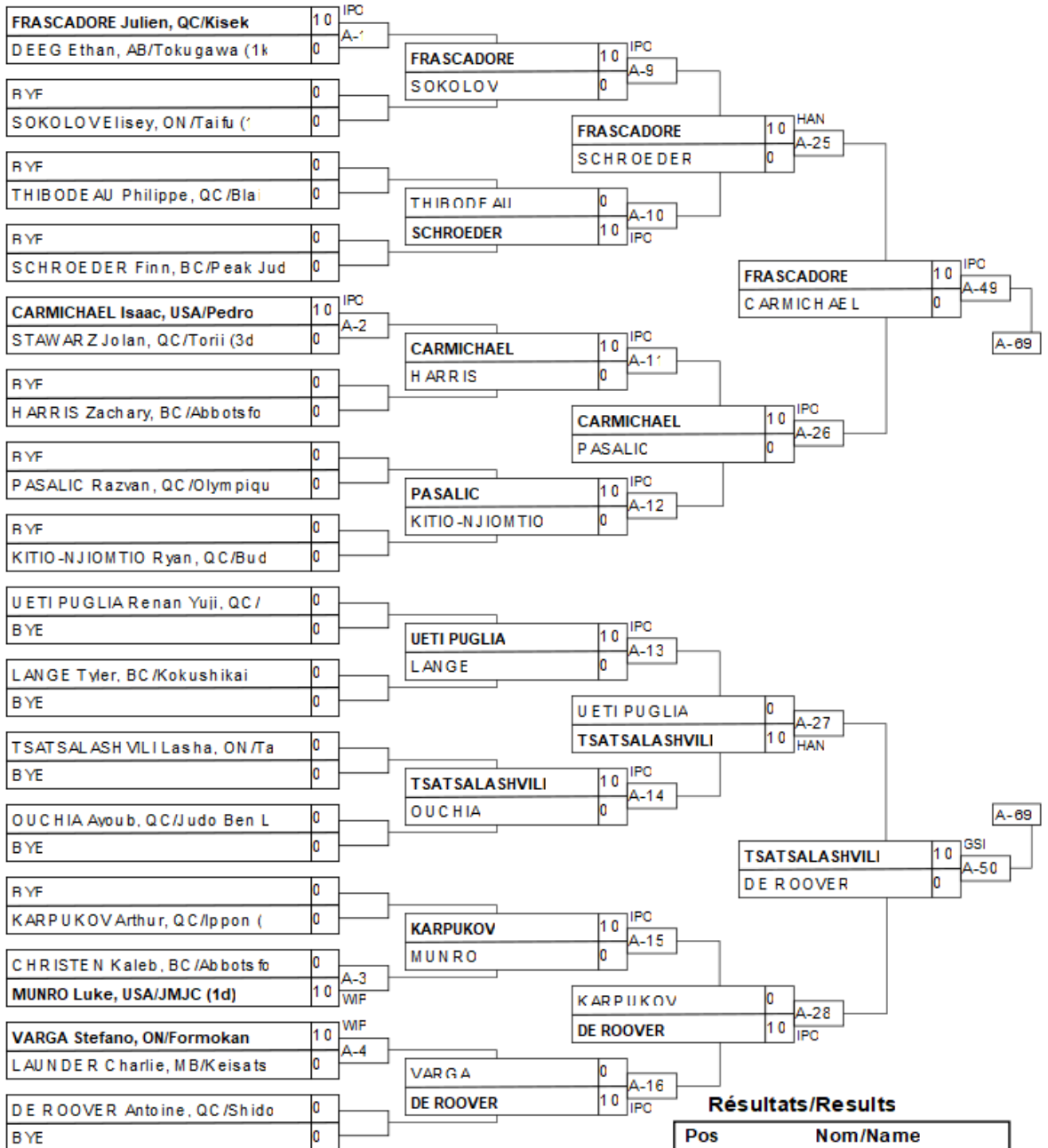

Résultats/Results

Pos	Nom/Name
1	YONEZUKA Jack, USA/Cranf
2	TSATSALASHVILI Lasha, ON
3	LEMIRE Justin, QC/Metrop
3	FRASCADORE Julien, QC/Ki

SENM -81kg 1k+

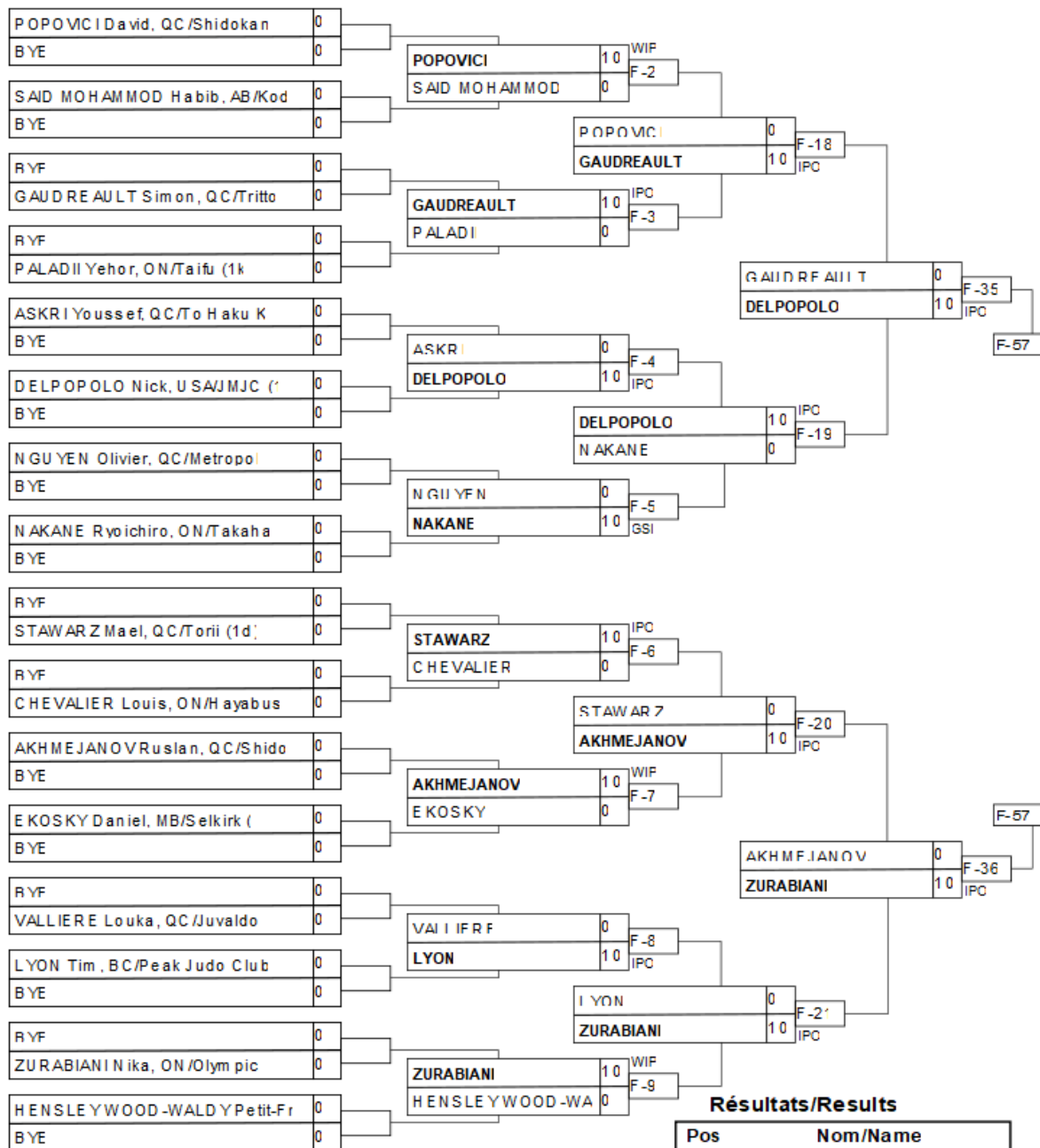

Résultats/Results

Pos	Nom/Name
1	MELADZE Jumber, ON/Taifu
2	ZURABIANI Nika, ON/Olympic
3	BLAIN Jeremie, QC/Bouche
4	GAUDREAU Simon, QC/Tritto

SENM -90kg 1k+

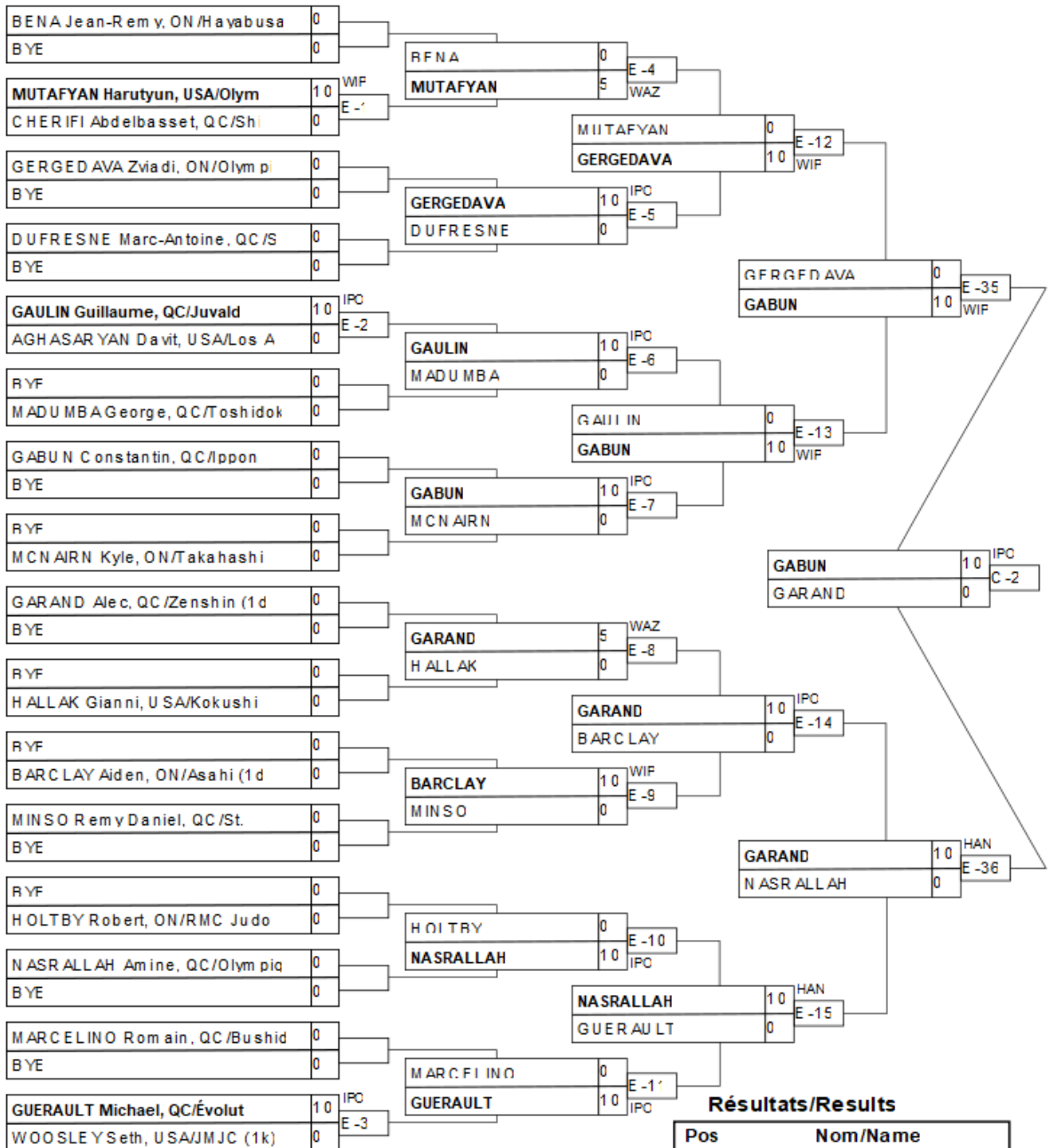

Résultats/Results

Pos	Nom/Name
1	GABUN Constantin, QC/Ipp
2	GARAND Alec, QC/Zenshin
3	GERGEDAVA Zviadi, ON/Oly
4	GAULIN Guillaume, QC/Juv

SENM 100kg 1k+

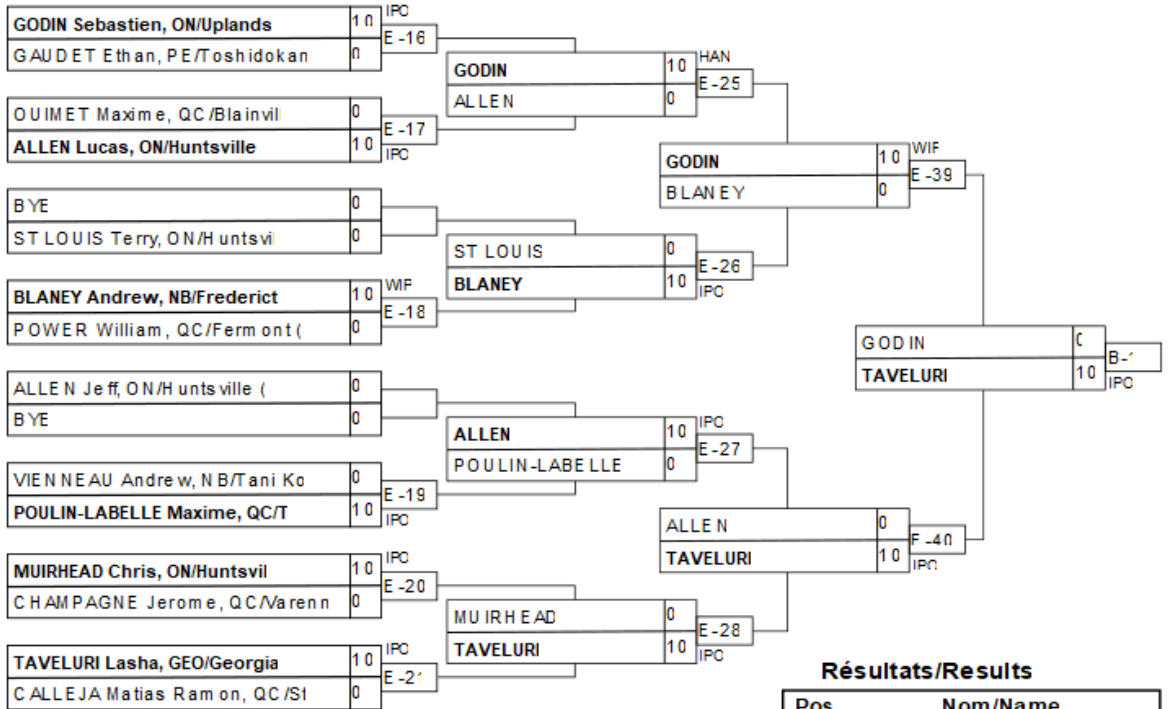

Résultats/Results

Pos	Nom/Name
1	TAVELURI Lasha, GEO/Geor
2	GODIN Sebastien, ON/Upla
3	BLANEY Andrew, NB/Freder
3	ALLEN Jeff, ON/Huntsvill