

# U10 Group 1

## Competitors

#	Name	Grade	Club	1	2	3	4	Wins	Pts	Pos
1	SYER Shain Jr.	5K	Airdrie	XX	10	10	10	3	30	1
2	NICA Veronica	5K	Ni-Ten		XX	10	10	2	20	2
3	TAYLOR Bennett	5K	Ryu Senshi			XX	10	1	10	3
4	HEHR Olivia	5K	Tolide				XX	0	0	4

## Matches

Match	White			Blue	Result	Time	Code
A-1	SYER Shain Jr.	1	2	NICA Veronica	10 - 0	1:30	IPO
A-2	TAYLOR Bennett	3	4	HEHR Olivia	10 - 0	2:00	IPO
A-7	SYER Shain Jr.	1	3	TAYLOR Bennett	10 - 0	1:30	IPO
A-8	NICA Veronica	2	4	HEHR Olivia	10 - 0	1:30	IPO
A-13	SYER Shain Jr.	1	4	HEHR Olivia	10 - 0	1:30	IPO
A-14	NICA Veronica	2	3	TAYLOR Bennett	10 - 0	1:30	IPO

## Results

Pos	Name
1	SYER Shain Jr., Airdrie
2	NICA Veronica, Ni-Ten
3	TAYLOR Bennett, Ryu Senshi

# U10 Group 2

## Competitors

#	Name	Grade	Club	1	2	3	4	Wins	Pts	Pos
1	LESSARD Avery-Marie	5K	Tolide	XX	10	10	10	3	30	1
2	KOBES Ava	5K	Ryu Senshi		XX	10	10	2	20	2
3	COELHO Ben	4K	Hayabusakan			XX	10	1	10	3
4	DIESMOS Chino	?	Hiro's				XX	0	0	4

## Matches

Match	White			Blue	Result	Time	Code
B-1	LESSARD Avery-Marie	1	2	KOBES Ava	10 - 0	1:30	IPO
B-2	COELHO Ben	3	4	DIESMOS Chino	10 - 0	2:00	IPO
B-7	LESSARD Avery-Marie	1	3	COELHO Ben	10 - 0	2:00	IPO
B-8	KOBES Ava	2	4	DIESMOS Chino	10 - 0	2:00	IPO
B-13	LESSARD Avery-Marie	1	4	DIESMOS Chino	10 - 0	1:30	IPO
B-14	KOBES Ava	2	3	COELHO Ben	10 - 0	1:30	IPO

## Results

Pos	Name
1	LESSARD Avery-Marie, Tolide
2	KOBES Ava, Ryu Senshi
3	COELHO Ben, Hayabusakan

# U10 Group 3

## Competitors

#	Name	Grade	Club	1	2	3	4	Wins	Pts	Pos
1	ABOUGHOSHE Poppy	5K	Kodokwai	XX	10	10	10	3	30	1
2	BOULGANA Rayan	?	Kodokwai		XX	10	10	2	20	2
3	OBERY Elliott	5K	Airdrie			XX	10	1	10	3
4	REID Greyson	5K	St. Albert				XX	0	0	4

## Matches

Match	White			Blue	Result	Time	Code
C-1	ABOUGHOSHE Poppy	1	2	BOULGANA Rayan	10 - 0	1:30	IPO
C-2	OBERY Elliott	3	4	REID Greyson	10 - 0	1:30	IPO
C-5	ABOUGHOSHE Poppy	1	3	OBERY Elliott	10 - 0	1:30	IPO
C-6	BOULGANA Rayan	2	4	REID Greyson	10 - 0	1:30	IPO
C-9	ABOUGHOSHE Poppy	1	4	REID Greyson	10 - 0	1:30	IPO
C-10	BOULGANA Rayan	2	3	OBERY Elliott	10 - 0	1:30	IPO

## Results

Pos	Name
1	ABOUGHOSHE Poppy, Kodokwai
2	BOULGANA Rayan, Kodokwai
3	OBERY Elliott, Airdrie

# U10 Group 4

## Competitors

#	Name	Grade	Club	1	2	3	4	Wins	Pts	Pos
1	SQUAREK Brooklyn	5K	Lethbridge	XX	10	10		2	20	3
2	PINDER Rhys	?	Lethbridge		XX			0	0	4
3	DENIE Greta	5K	Barracuda		10	XX	10	2	20	2
4	MCALPINE Atticus	5K	Medicine Hat	10	10		XX	2	20	1

## Matches

Match	White			Blue	Result	Time	Code
D-1	SQUAREK Brooklyn	1	2	PINDER Rhys	10 - 0	0:00	IPO
D-2	DENIE Greta	3	4	MCALPINE Atticus	10 - 0	1:22	IPO
D-5	SQUAREK Brooklyn	1	3	DENIE Greta	10 - 0	1:30	IPO
D-6	PINDER Rhys	2	4	MCALPINE Atticus	0 - 10	1:30	IPO
D-9	SQUAREK Brooklyn	1	4	MCALPINE Atticus	0 - 10	0:00	IPO
D-10	PINDER Rhys	2	3	DENIE Greta	0 - 10	1:30	IPO

## Results

Pos	Name
1	MCALPINE Atticus, Medicine Hat
1	DENIE Greta, Barracuda
1	SQUAREK Brooklyn, Lethbridge

# U10 Group 5

## Competitors

#	Name	Grade	Club	1	2	3	4	Wins	Pts	Pos
1	MOHAN Jaxon	5K	Airdrie	XX	10	10	10	3	30	1
2	PERRON Carmen	5K	Hoku Sei Kan		XX	10	10	2	20	2
3	CRAEVOI Alexis	5K	Kodokwai			XX	10	1	10	3
4	SMOOK Daniel	4K	Avonhurst				XX	0	0	4

## Matches

Match	White			Blue	Result	Time	Code
A-3	MOHAN Jaxon	1	2	PERRON Carmen	10 - 0	1:17	IPO
A-4	CRAEVOI Alexis	3	4	SMOOK Daniel	10 - 0	1:30	IPO
A-9	MOHAN Jaxon	1	3	CRAEVOI Alexis	10 - 0	1:30	IPO
A-10	PERRON Carmen	2	4	SMOOK Daniel	10 - 0	1:30	IPO
A-15	MOHAN Jaxon	1	4	SMOOK Daniel	10 - 0	1:30	IPO
A-16	PERRON Carmen	2	3	CRAEVOI Alexis	10 - 0	1:30	IPO

## Results

Pos	Name
1	MOHAN Jaxon, Airdrie
2	PERRON Carmen, Hoku Sei Kan
3	CRAEVOI Alexis, Kodokwai

# U10 Group 6

## Competitors

#	Name	Grade	Club	1	2	3	4	Wins	Pts	Pos
1	CALVERT Miya	4K	Kodokwai	XX	10	10	10	3	30	1
2	COLNEY Bryn	?	Kodokwai		XX	10	10	2	20	2
3	BERNATCHEZ Kinsley	5K	Lethbridge			XX	10	1	10	3
4	REID Jaxon	5K	Airdrie				XX	0	0	4

## Matches

Match	White			Blue	Result	Time	Code
B-3	CALVERT Miya	1	2	COLNEY Bryn	10 - 0	0:00	IPO
B-4	BERNATCHEZ Kinsley	3	4	REID Jaxon	10 - 0	0:00	IPO
B-9	CALVERT Miya	1	3	BERNATCHEZ Kinsley	10 - 0	2:00	IPO
B-10	COLNEY Bryn	2	4	REID Jaxon	10 - 0	2:00	IPO
B-15	CALVERT Miya	1	4	REID Jaxon	10 - 0	1:30	IPO
B-16	COLNEY Bryn	2	3	BERNATCHEZ Kinsley	10 - 0	1:30	IPO

## Results

Pos	Name
1	CALVERT Miya, Kodokwai
2	COLNEY Bryn, Kodokwai
3	BERNATCHEZ Kinsley, Lethbridge

# U10 Group 7

## Competitors

#	Name	Grade	Club	1	2	3	4	Wins	Pts	Pos
1	SHERK Canyon	5K+	GP Martial Arts	XX	10	10	10	3	30	1
2	SQUAREK Jace	5K	Lethbridge		XX	10	10	2	20	2
3	TALBOT Théo	4K	Baie-Comeau			XX	10	1	10	3
4	HIEBERT Jacob	5K	Flin Flon				XX	0	0	4

## Matches

Match	White			Blue	Result	Time	Code
C-3	SHERK Canyon	1	2	SQUAREK Jace	10 - 0	1:30	IPO
C-4	TALBOT Théo	3	4	HIEBERT Jacob	10 - 0	0:07	IPO
C-7	SHERK Canyon	1	3	TALBOT Théo	10 - 0	0:01	IPO
C-8	SQUAREK Jace	2	4	HIEBERT Jacob	10 - 0	1:30	IPO
C-11	SHERK Canyon	1	4	HIEBERT Jacob	10 - 0	1:30	IPO
C-12	SQUAREK Jace	2	3	TALBOT Théo	10 - 0	1:30	IPO

## Results

Pos	Name
1	SHERK Canyon, GP Martial Arts
2	SQUAREK Jace, Lethbridge
3	TALBOT Théo, Baie-Comeau

# U10 Group 8

## Competitors

#	Name	Grade	Club	1	2	3	4	Wins	Pts	Pos
1	AU Natalie	?	Peak Judo Club	XX	10		10	2	20	2
2	PAKULA Anya	5K	Hart		XX		10	1	10	3
3	HEBER Lorenzo	4K	Tokugawa	10	10	XX	10	3	30	1
4	CROUCHER Max	5K	Ni-Ten				XX	0	0	4

## Matches

Match	White			Blue	Result	Time	Code
D-3	AU Natalie	1	2	PAKULA Anya	10 - 0	0:00	IPO
D-4	HEBER Lorenzo	3	4	CROUCHER Max	10 - 0	1:30	IPO
D-7	AU Natalie	1	3	HEBER Lorenzo	0 - 10	1:30	IPO
D-8	PAKULA Anya	2	4	CROUCHER Max	10 - 0	1:30	IPO
D-11	AU Natalie	1	4	CROUCHER Max	10 - 0	1:30	IPO
D-12	PAKULA Anya	2	3	HEBER Lorenzo	0 - 10	1:30	IPO

## Results

Pos	Name
1	HEBER Lorenzo, Tokugawa
2	AU Natalie, Peak Judo Club
3	PAKULA Anya, Hart



# U10 Group 9

## Competitors

#	Name	Grade	Club	1	2	3	4	Wins	Pts	Pos
1	ELHEGAZY Adam	?	Kodokwai	XX	10	10	10	3	30	1
2	SOKOLOV Andrey	5K	Kodokwai		XX	10	10	2	20	2
3	STEIGER Claire	4D	Prince George			XX	10	1	10	3
4	FELDMAN Solomon	5K	Kodokwai				XX	0	0	4

## Matches

Match	White			Blue	Result	Time	Code
A-5	ELHEGAZY Adam	1	2	SOKOLOV Andrey	10 - 0	1:30	IPO
A-6	STEIGER Claire	3	4	FELDMAN Solomon	10 - 0	1:30	IPO
A-11	ELHEGAZY Adam	1	3	STEIGER Claire	10 - 0	1:30	IPO
A-12	SOKOLOV Andrey	2	4	FELDMAN Solomon	10 - 0	1:30	IPO
A-17	ELHEGAZY Adam	1	4	FELDMAN Solomon	10 - 0	1:30	IPO
A-18	SOKOLOV Andrey	2	3	STEIGER Claire	10 - 0	1:30	IPO

## Results

Pos	Name
1	ELHEGAZY Adam, Kodokwai
2	SOKOLOV Andrey, Kodokwai
3	STEIGER Claire, Prince George

# U10 Group 10

## Competitors

#	Name	Grade	Club	1	2	3	4	Wins	Pts	Pos
1	BLAKE Bryce	5K	Hoku Sei Kan	XX	10	10	10	3	30	1
2	NIELSEN Bryce	5K	Airdrie		XX	10	10	2	20	2
3	THOMAS Tavish	5K	Hart			XX	10	1	10	3
4	O'GORMAN Eimear	5K+	Nakamura				XX	0	0	4

## Matches

Match	White			Blue	Result	Time	Code
B-5	BLAKE Bryce	1	2	NIELSEN Bryce	10 - 0	2:00	IPO
B-6	THOMAS Tavish	3	4	O'GORMAN Eimear	10 - 0	2:00	IPO
B-11	BLAKE Bryce	1	3	THOMAS Tavish	10 - 0	2:00	IPO
B-12	NIELSEN Bryce	2	4	O'GORMAN Eimear	10 - 0	2:00	IPO
B-17	BLAKE Bryce	1	4	O'GORMAN Eimear	10 - 0	1:30	IPO
B-18	NIELSEN Bryce	2	3	THOMAS Tavish	10 - 0	1:30	IPO

## Results

Pos	Name
1	BLAKE Bryce, Hoku Sei Kan
2	NIELSEN Bryce, Airdrie
3	THOMAS Tavish, Hart

# U12F Group 1

## Competitors

#	Name	Grade	Club	1	2	3	4	Wins	Pts	Pos
1	ROTH Alexis	?	Airdrie	XX	10	10	10	3	30	1
2	SOILAND Lexie	5K	Airdrie		XX	10	10	2	20	2
3	WHITE Kaylynn	5K	Tolide			XX	10	1	10	3
4	ZOTZMAN Sierra	4K	Kodokwai				XX	0	0	4

## Matches

Match	White			Blue	Result	Time	Code
B-23	ROTH Alexis	1	2	SOILAND Lexie	10 - 0	1:30	IPO
B-24	WHITE Kaylynn	3	4	ZOTZMAN Sierra	10 - 0	1:30	IPO
B-31	ROTH Alexis	1	3	WHITE Kaylynn	10 - 0	1:30	IPO
B-32	SOILAND Lexie	2	4	ZOTZMAN Sierra	10 - 0	1:30	IPO
B-39	ROTH Alexis	1	4	ZOTZMAN Sierra	10 - 0	1:30	IPO
B-40	SOILAND Lexie	2	3	WHITE Kaylynn	10 - 0	1:30	IPO

## Results

Pos	Name
1	ROTH Alexis, Airdrie
2	SOILAND Lexie, Airdrie
3	WHITE Kaylynn, Tolide

# U12F Group 2

## Competitors

#	Name	Grade	Club	1	2	3	4	Wins	Pts	Pos
1	TKACH Galaxy	5K+	Ni-Ten	XX	10			1	10	2
2	KINLEY Eileigh	?	Airdrie		XX		10	1	10	3
3	TRITTON Taylor	3K	Tritton	10	10	XX	10	3	30	1
4	BOESE Kate	5K	Tokugawa	10			XX	1	10	4

## Matches

Match	White			Blue	Result	Time	Code
C-20	TKACH Galaxy	1	2	KINLEY Eileigh	10 - 0	1:30	IPO
C-21	TRITTON Taylor	3	4	BOESE Kate	10 - 0	1:30	IPO
C-29	TKACH Galaxy	1	3	TRITTON Taylor	0 - 10	1:30	IPO
C-30	KINLEY Eileigh	2	4	BOESE Kate	10 - 0	1:30	IPO
C-38	TKACH Galaxy	1	4	BOESE Kate	0 - 10	1:30	IPO
C-39	KINLEY Eileigh	2	3	TRITTON Taylor	0 - 10	1:30	IPO

## Results

Pos	Name
1	TRITTON Taylor, Tritton
2	TKACH Galaxy, Ni-Ten
2	KINLEY Eileigh, Airdrie
2	BOESE Kate, Tokugawa

# U12F Group 3

## Competitors

#	Name	Grade	Club	1	2	3	4	Wins	Pts	Pos
1	CALVERT Yumi	5K	Kodokwai	XX			10	1	10	3
2	SEEMAN Brooklyn	4K	Lethbridge	5	XX		10	2	15	2
3	LEUS Irma	?	St. Albert	10	10	XX	10	3	30	1
4	BROWN Morgan	5K	Tolide				XX	0	0	4

## Matches

Match	White	Blue	Result	Time	Code
D-19	CALVERT Yumi	1 2 SEEMAN Brooklyn	0 - 5	1:30	WAZ
D-20	LEUS Irma	3 4 BROWN Morgan	10 - 0	1:30	IPO
D-28	CALVERT Yumi	1 3 LEUS Irma	0 - 10	1:30	IPO
D-29	SEEMAN Brooklyn	2 4 BROWN Morgan	10 - 0	1:30	IPO
D-37	CALVERT Yumi	1 4 BROWN Morgan	10 - 0	1:30	IPO
D-38	SEEMAN Brooklyn	2 3 LEUS Irma	0 - 10	1:30	IPO

## Results

Pos	Name
1	LEUS Irma, St. Albert
2	SEEMAN Brooklyn, Lethbridge
3	CALVERT Yumi, Kodokwai

# U12F Group 4

## Competitors

#	Name	Grade	Club	1	2	3	Wins	Pts	Pos
1	FORTIER Ivy	5D	St. Albert	XX	10	10	2	20	1
2	OUDOVIKINE Ksenia	?	Taifu		XX	10	1	10	2
3	BRADFORD Carys	5K+	Ishi Yama			XX	0	0	3

## Matches

Match	White			Blue	Result	Time	Code
A-26	FORTIER Ivy	1	2	OUDOVIKINE Ksenia	10 - 0	1:30	IPO
A-34	FORTIER Ivy	1	3	BRADFORD Carys	10 - 0	1:30	IPO
A-42	OUDOVIKINE Ksenia	2	3	BRADFORD Carys	10 - 0	1:30	IPO

## Results

Pos	Name
1	FORTIER Ivy, St. Albert
2	OUDOVIKINE Ksenia, Taifu

# U12F Group 5

## Competitors

#	Name	Grade	Club	1	2	3	4	Wins	Pts	Pos
1	MORRIS Cadence	5K	Hart	XX	10	10	10	3	30	1
2	DYCK Jaycie	?	Hart		XX	10	10	2	20	2
3	MOMOT Mariya	5K	Hoku Sei Kan			XX	10	1	10	3
4	DENIE Nora	4K	Barracuda				XX	0	0	4

## Matches

Match	White			Blue	Result	Time	Code
B-25	MORRIS Cadence	1	2	DYCK Jaycie	10 - 0	1:30	IPO
B-26	MOMOT Mariya	3	4	DENIE Nora	10 - 0	1:30	IPO
B-33	MORRIS Cadence	1	3	MOMOT Mariya	10 - 0	1:30	IPO
B-34	DYCK Jaycie	2	4	DENIE Nora	10 - 0	1:30	IPO
B-41	MORRIS Cadence	1	4	DENIE Nora	10 - 0	1:30	IPO
B-42	DYCK Jaycie	2	3	MOMOT Mariya	10 - 0	1:30	IPO

## Results

Pos	Name
1	MORRIS Cadence, Hart
2	DYCK Jaycie, Hart
3	MOMOT Mariya, Hoku Sei Kan

# U12F Group 6

## Competitors

#	Name	Grade	Club	1	2	1	2	1	2	Wins	Pts	Pos
1	MORRISON Eilidh	4K	Ishi Yama	XX	10	XX	10	XX		2	20	1
2	DION Oryx	5K	Medicine Hat		XX		XX		XX	0	0	2

## Matches

Match	White			Blue	Result	Time	Code
D-21	MORRISON Eilidh	1	2	DION Oryx	10 - 0	0:00	IPO
D-30	DION Oryx	2	1	MORRISON Eilidh	0 - 10	1:30	IPO
D-39	MORRISON Eilidh	1	2	DION Oryx			

## Results

Pos	Name
1	MORRISON Eilidh, Ishi Yama



# U12M Group 1

## Competitors

#	Name	Grade	Club	1	2	3	4	Wins	Pts	Pos
1	SMITS Zachary	3K+	Tokugawa	XX	10	10	10	3	30	1
2	DEMAERE Lucas	4K	Lethbridge		XX	10	10	2	20	2
3	VERBITSKY Victor	5K	Kodokwai			XX	10	1	10	3
4	BURRINGTON Bruce	5K	Ryu Senshi				XX	0	0	4

## Matches

Match	White			Blue	Result	Time	Code
C-13	SMITS Zachary	1	2	DEMAERE Lucas	10 - 0	1:30	IPO
C-14	VERBITSKY Victor	3	4	BURRINGTON Bruce	10 - 0	1:30	IPO
C-22	SMITS Zachary	1	3	VERBITSKY Victor	10 - 0	1:30	IPO
C-23	DEMAERE Lucas	2	4	BURRINGTON Bruce	10 - 0	1:30	IPO
C-31	SMITS Zachary	1	4	BURRINGTON Bruce	10 - 0	1:30	IPO
C-32	DEMAERE Lucas	2	3	VERBITSKY Victor	10 - 0	1:30	IPO

## Results

Pos	Name
1	SMITS Zachary, Tokugawa
2	DEMAERE Lucas, Lethbridge
3	VERBITSKY Victor, Kodokwai

# U12M Group 2

## Competitors

#	Name	Grade	Club	1	2	3	4	Wins	Pts	Pos
1	SIMMS Matthew	5K+	Airdrie	XX				0	0	4
2	NEUFELD Toshi	5K+	Airdrie	10	XX	10		2	20	2
3	EMERSON Kolton	?	Abbotsford	10		XX		1	10	3
4	TARASENKO Maksym	5K	Ishi Yama	10	10	10	XX	3	30	1

## Matches

Match	White			Blue	Result	Time	Code
D-13	SIMMS Matthew	1	2	NEUFELD Toshi	0 - 10	1:30	IPO
D-14	EMERSON Kolton	3	4	TARASENKO Maksym	0 - 10	1:30	IPO
D-22	SIMMS Matthew	1	3	EMERSON Kolton	0 - 10	1:30	IPO
D-23	NEUFELD Toshi	2	4	TARASENKO Maksym	0 - 10	1:30	IPO
D-31	SIMMS Matthew	1	4	TARASENKO Maksym	0 - 10	1:30	IPO
D-32	NEUFELD Toshi	2	3	EMERSON Kolton	10 - 0	1:30	IPO

## Results

Pos	Name
1	TARASENKO Maksym, Ishi Yama
2	NEUFELD Toshi, Airdrie
3	EMERSON Kolton, Abbotsford

# U12M Group 3

## Competitors

#	Name	Grade	Club	1	2	3	Wins	Pts	Pos
1	REYNANTE Samson Nathaniel	4K	Nakamura	XX	10	10	2	20	1
2	MEJERY Alexey	?	Taifu		XX	10	1	10	2
3	CARAUS Dominik	3K	Ishi Yama			XX	0	0	3

## Matches

Match	White			Blue	Result	Time	Code
A-19	REYNANTE Samson Nathaniel	1	2	MEJERY Alexey	10 - 0	1:30	IPO
A-27	REYNANTE Samson Nathaniel	1	3	CARAUS Dominik	10 - 0	1:30	IPO
A-35	MEJERY Alexey	2	3	CARAUS Dominik	10 - 0	1:30	IPO

## Results

Pos	Name
1	REYNANTE Samson Nathaniel, Nakamura
2	MEJERY Alexey, Taifu

# U12M Group 4

## Competitors

#	Name	Grade	Club	1	2	3	4	Wins	Pts	Pos
1	DEMENEV Peter	?	Olympic	XX	10	10	10	3	30	1
2	MCALPINE Brolan	4K	Medicine Hat		XX	10	10	2	20	2
3	DAHL Cameron	5K	Regina Y			XX	10	1	10	3
4	TALBOT Cadel	?	Baie-Comeau				XX	0	0	4

## Matches

Match	White			Blue	Result	Time	Code
B-19	DEMENEV Peter	1	2	MCALPINE Brolan	10 - 0	1:30	IPO
B-20	DAHL Cameron	3	4	TALBOT Cadel	10 - 0	1:30	IPO
B-27	DEMENEV Peter	1	3	DAHL Cameron	10 - 0	1:30	IPO
B-28	MCALPINE Brolan	2	4	TALBOT Cadel	10 - 0	1:30	IPO
B-35	DEMENEV Peter	1	4	TALBOT Cadel	10 - 0	1:30	IPO
B-36	MCALPINE Brolan	2	3	DAHL Cameron	10 - 0	1:30	IPO

## Results

Pos	Name
1	DEMENEV Peter, Olympic
2	MCALPINE Brolan, Medicine Hat
3	DAHL Cameron, Regina Y

# U12M Group 5

## Competitors

#	Name	Grade	Club	1	2	3	4	Wins	Pts	Pos
1	VERE Joseph	5K	Medicine Hat	XX	10	10	10	3	30	1
2	KLIPPENSTINE Wyatt	5K+	Airdrie		XX		10	1	10	3
3	LE BRIS Ewen	?	Peak Judo Club		10	XX	10	2	20	2
4	WALTON Justin	5K	Lethbridge				XX	0	0	4

## Matches

Match	White			Blue	Result	Time	Code
C-15	VERE Joseph	1	2	KLIPPENSTINE Wyatt	10 - 0	1:30	IPO
C-16	LE BRIS Ewen	3	4	WALTON Justin	10 - 0	0:01	IPO
C-24	VERE Joseph	1	3	LE BRIS Ewen	10 - 0	1:30	IPO
C-25	KLIPPENSTINE Wyatt	2	4	WALTON Justin	10 - 0	0:01	IPO
C-33	VERE Joseph	1	4	WALTON Justin	10 - 0	0:01	IPO
C-34	KLIPPENSTINE Wyatt	2	3	LE BRIS Ewen	0 - 10	1:30	IPO

## Results

Pos	Name
1	VERE Joseph, Medicine Hat
2	LE BRIS Ewen, Peak Judo Club
3	KLIPPENSTINE Wyatt, Airdrie

# U12M Group 6

## Competitors

#	Name	Grade	Club	1	2	3	4	Wins	Pts	Pos
1	MARTIN Logan	5K+	Hart	XX	10			1	10	2
2	BLOCK Van	5K	Hart		XX		10	1	10	3
3	ABRAMOVICH David	4K+	Olympic	10	5	XX	10	3	25	1
4	ALIZADA David	5K	Kodokwai	5			XX	1	5	4

## Matches

Match	White			Blue	Result	Time	Code
D-15	MARTIN Logan	1	2	BLOCK Van	10 - 0	1:30	IPO
D-16	ABRAMOVICH David	3	4	ALIZADA David	10 - 0	1:30	IPO
D-24	MARTIN Logan	1	3	ABRAMOVICH David	0 - 10	1:30	IPO
D-25	BLOCK Van	2	4	ALIZADA David	10 - 0	1:30	IPO
D-33	MARTIN Logan	1	4	ALIZADA David	0 - 5	1:30	WAZ
D-34	BLOCK Van	2	3	ABRAMOVICH David	0 - 5	1:30	WAZ

## Results

Pos	Name
1	ABRAMOVICH David, Olympic
2	MARTIN Logan, Hart
3	BLOCK Van, Hart
4	ALIZADA David, Kodokwai

# U12M Group 7

## Competitors

#	Name	Grade	Club	1	2	3	4	Wins	Pts	Pos
1	BENNETT Shaye	5K+	Ni-Ten	XX	10	10	10	3	30	1
2	MATTRWD Yannal	?	St. Albert		XX	10	10	2	20	2
3	AMAR Vihaan	?	White Rock			XX	10	1	10	3
4	LAURIE Lee	4K	Hiro's				XX	0	0	4

## Matches

Match	White		Blue	Result	Time	Code	
A-20	BENNETT Shaye	1	2	MATTRWD Yannal	10 - 0	1:30	IPO
A-21	AMAR Vihaan	3	4	LAURIE Lee	10 - 0	1:30	IPO
A-28	BENNETT Shaye	1	3	AMAR Vihaan	10 - 0	1:30	IPO
A-29	MATTRWD Yannal	2	4	LAURIE Lee	10 - 0	1:30	IPO
A-36	BENNETT Shaye	1	4	LAURIE Lee	10 - 0	1:30	IPO
A-37	MATTRWD Yannal	2	3	AMAR Vihaan	10 - 0	1:30	IPO

## Results

Pos	Name
1	BENNETT Shaye, Ni-Ten
2	MATTRWD Yannal, St. Albert
3	AMAR Vihaan, White Rock

# U12M Group 8

## Competitors

#	Name	Grade	Club	1	2	3	4	Wins	Pts	Pos
1	PINDER Russell	?	Lethbridge	XX	10	10	10	3	30	1
2	HOJANEPESOV Yakup	5K	Kodokwai		XX	10	10	2	20	2
3	CAVANAGH Konnor	?	Invermere			XX	10	1	10	3
4	WEISE Emerest	5K+	Tolide				XX	0	0	4

## Matches

Match	White			Blue	Result	Time	Code
B-21	PINDER Russell	1	2	HOJANEPESOV Yakup	10 - 0	1:30	IPO
B-22	CAVANAGH Konnor	3	4	WEISE Emerest	10 - 0	1:30	IPO
B-29	PINDER Russell	1	3	CAVANAGH Konnor	10 - 0	1:30	IPO
B-30	HOJANEPESOV Yakup	2	4	WEISE Emerest	10 - 0	1:30	IPO
B-37	PINDER Russell	1	4	WEISE Emerest	10 - 0	1:30	IPO
B-38	HOJANEPESOV Yakup	2	3	CAVANAGH Konnor	10 - 0	1:30	IPO

## Results

Pos	Name
1	PINDER Russell, Lethbridge
2	HOJANEPESOV Yakup, Kodokwai
3	CAVANAGH Konnor, Invermere



# U12M Group 9

## Competitors

#	Name	Grade	Club	1	2	3	4	Wins	Pts	Pos
1	TANAKA SVERZUT Fernando	4K	Police Jr.	XX	10	10		2	20	1
2	WYERS Drake	5K	Hart		XX	10	10	2	20	2
3	BORAS Brandon	?	Lethbridge			XX	10	1	10	3
4	ZAHR Yousef	?	Hayabusa	10			XX	1	10	4

## Matches

Match	White			Blue	Result	Time	Code
C-17	TANAKA SVERZUT Fernando	1	2	WYERS Drake	10 - 0	1:30	IPO
C-18	BORAS Brandon	3	4	ZAHR Yousef	10 - 0	1:30	IPO
C-26	TANAKA SVERZUT Fernando	1	3	BORAS Brandon	10 - 0	1:30	IPO
C-27	WYERS Drake	2	4	ZAHR Yousef	10 - 0	1:30	IPO
C-35	TANAKA SVERZUT Fernando	1	4	ZAHR Yousef	0 - 10	1:30	IPO
C-36	WYERS Drake	2	3	BORAS Brandon	10 - 0	1:30	IPO

## Results

Pos	Name
1	TANAKA SVERZUT Fernando, Police Jr.
2	WYERS Drake, Hart
3	BORAS Brandon, Lethbridge
4	ZAHR Yousef, Hayabusa

# U14F -30 kg

## Competitors

#	Name	Grade	Club	1	2	3	Wins	Pts	Pos
1	KEOMANIVONG Thea	5K	Tolide	XX		10	1	10	2
2	DEMAERE Miya	3K	Lethbridge	10	XX	10	2	20	1
3	SYER Rylee	5K	Airdrie			XX	0	0	3

## Matches

Match	White			Blue	Result	Time	Code
C-72	KEOMANIVONG Thea	1	2	DEMAERE Miya	0 - 10	2:31	IPO
C-78	KEOMANIVONG Thea	1	3	SYER Rylee	10 - 0	0:09	IPO
C-85	DEMAERE Miya	2	3	SYER Rylee	10 - 0	2:01	WIP

## Results

Pos	Name
1	DEMAERE Miya, Lethbridge
2	KEOMANIVONG Thea, Tolide

# U14F -36 kg

## Competitors

#	Name	Grade	Club	1	2	3	4	Wins	Pts	Pos
1	MANAILA Nikole-Daria	?	Ippon	XX	10	10	10	3	30	1
2	DIOME Claire	4K+	Tritton		XX		10	1	10	3
3	ELEMENT Zoe	4K	Club Judo Otoshi		5	XX	10	2	15	2
4	MOHAN Emma	5K	Airdrie				XX	0	0	4

## Matches

Match	White			Blue	Result	Time	Code
D-69	MANAILA Nikole-Daria	1	2	DIOME Claire	10 - 0	2:33	IPO
D-70	ELEMENT Zoe	3	4	MOHAN Emma	10 - 0	0:12	IPO
D-74	MANAILA Nikole-Daria	1	3	ELEMENT Zoe	10 - 0	2:46	WIP
D-75	DIOME Claire	2	4	MOHAN Emma	10 - 0	0:53	WIP
D-82	MANAILA Nikole-Daria	1	4	MOHAN Emma	10 - 0	0:34	IPO
D-83	DIOME Claire	2	3	ELEMENT Zoe	0 - 5	3:00	WAZ

## Results

Pos	Name
1	MANAILA Nikole-Daria, Ippon
2	ELEMENT Zoe, Club Judo Otoshi
3	DIOME Claire, Tritton

# U14F -40 kg

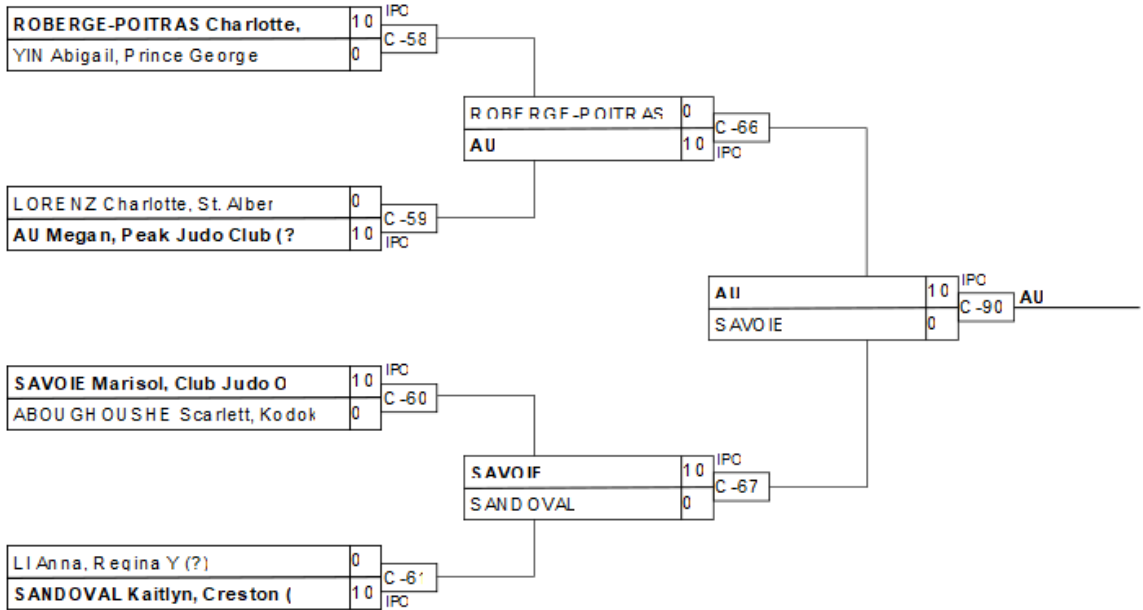

## Results

Pos	Name
1	AU Megan, Peak Judo Club
2	SAVOIE Marisol, Club Jud
3	ROBERGE-POITRAS Charlott
3	SANDOVAL Kaitlyn, Cresto

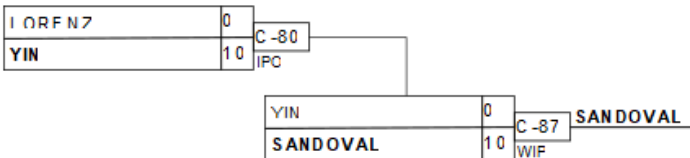
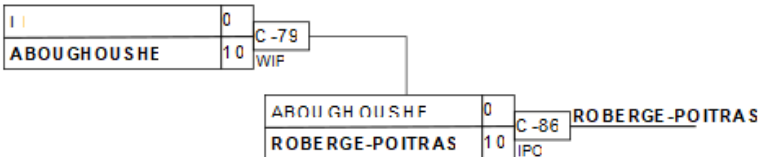

# U14F -44 kg

## Competitors

#	Name	Grade	Club	1	2	3	4	Wins	Pts	Pos
1	JIA Emma	3K	Kodokwai	XX			5	1	5	3
2	KARAS Christina	3K	Kodokwai	10	XX	10	10	3	30	1
3	GRISALES Jessica	3K	GP Martial Arts	5		XX	10	2	15	2
4	TOMPKINS Presley	?	Lethbridge				XX	0	0	4

## Matches

Match	White			Blue	Result	Time	Code
A-59	JIA Emma	1	2	KARAS Christina	0 - 10	0:30	IPO
A-60	GRISALES Jessica	3	4	TOMPKINS Presley	10 - 0	1:17	IPO
A-68	JIA Emma	1	3	GRISALES Jessica	0 - 5	3:00	WAZ
A-69	KARAS Christina	2	4	TOMPKINS Presley	10 - 0	2:18	IPO
A-78	JIA Emma	1	4	TOMPKINS Presley	5 - 0	3:00	WAZ
A-79	KARAS Christina	2	3	GRISALES Jessica	10 - 0	3:00	IPO

## Results

Pos	Name
1	KARAS Christina, Kodokwai
2	GRISALES Jessica, GP Martial Arts
3	JIA Emma, Kodokwai

# U14F -48 kg

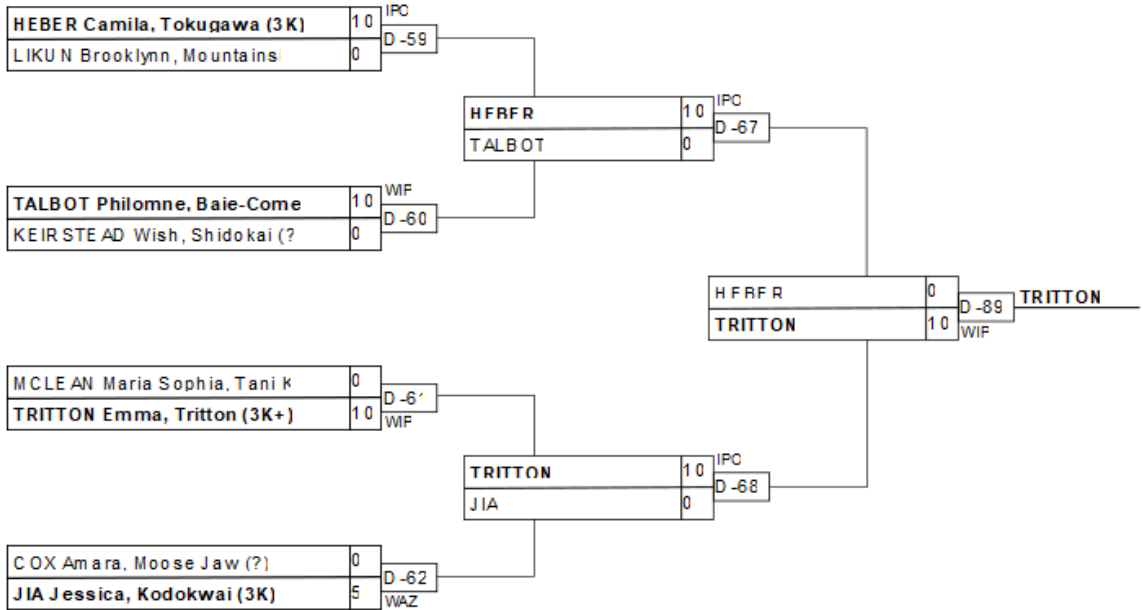

## Results

Pos	Name
1	TRITTON Emma, Tritton (3
2	HEBER Camila, Tokugawa (
3	TALBOT Philomne, Baie-C
3	KEIRSTEAD Wish, Shidokai

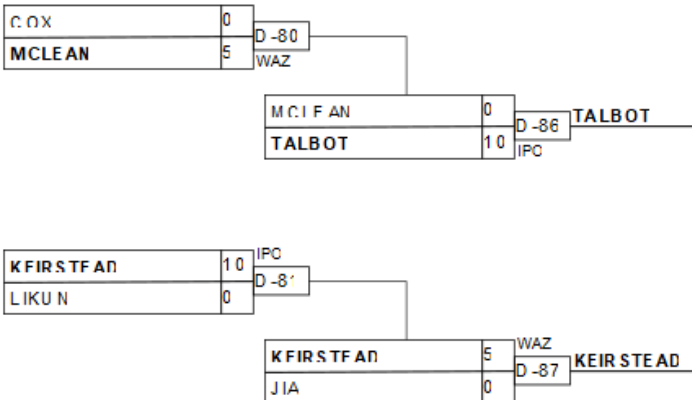

# U14F -52 kg

## Competitors

#	Name	Grade	Club	1	2	3	Wins	Pts	Pos
1	DEEG Annaka	3K	Tokugawa	XX	10	10	2	20	1
2	MORASCH Finley	3K	Lethbridge		XX		0	0	3
3	O'GORMAN Niamh	4K	Nakamura		10	XX	1	10	2

## Matches

Match	White			Blue	Result	Time	Code
B-67	DEEG Annaka	1	2	MORASCH Finley	10 - 0	1:00	WIP
B-75	DEEG Annaka	1	3	O'GORMAN Niamh	10 - 0	1:21	WIP
B-84	MORASCH Finley	2	3	O'GORMAN Niamh	0 - 10	1:00	WIP

## Results

Pos	Name
1	DEEG Annaka, Tokugawa
2	O'GORMAN Niamh, Nakamura

# U14F -63 kg

## Competitors

#	Name	Grade	Club	1	2	1	2	1	2	Wins	Pts	Pos
1	SUMMERS Victoria	3K	Ajax Budokan	XX	10	XX	10	XX		2	20	1
2	FOWLER Alicia	?	Tani Koi		XX		XX		XX	0	0	2

## Matches

Match	White			Blue	Result	Time	Code
B-68	SUMMERS Victoria	1	2	FOWLER Alicia	10 - 0	0:14	IPO
B-76	FOWLER Alicia	2	1	SUMMERS Victoria	0 - 10	0:28	IPO
B-85	SUMMERS Victoria	1	2	FOWLER Alicia			

## Results

Pos	Name
1	SUMMERS Victoria, Ajax Budokan



# U14F +63 kg

## Competitors

#	Name	Grade	Club	1	2	3	4	Wins	Pts	Pos
1	ALIYEVA Emiliya	3K	Hiro's	XX	10	10	10	3	30	1
2	HOOVER Grace	4K	Kodokwai		XX	10	10	2	20	2
3	WIENS Josie	4K	Flin Flon			XX	10	1	10	3
4	WATT Paisley	5K	Hart				XX	0	0	4

## Matches

Match	White			Blue	Result	Time	Code
B-60	ALIYEVA Emiliya	1	2	HOOVER Grace	10 - 0	0:00	IPO
B-61	WIENS Josie	3	4	WATT Paisley	10 - 0	0:13	IPO
B-69	ALIYEVA Emiliya	1	3	WIENS Josie	10 - 0	0:11	IPO
B-70	HOOVER Grace	2	4	WATT Paisley	10 - 0	0:07	IPO
B-77	ALIYEVA Emiliya	1	4	WATT Paisley	10 - 0	0:06	IPO
B-78	HOOVER Grace	2	3	WIENS Josie	10 - 0	1:28	IPO

## Results

Pos	Name
1	ALIYEVA Emiliya, Hiro's
2	HOOVER Grace, Kodokwai
3	WIENS Josie, Flin Flon

# U14M -32 kg

## Competitors

#	Name	Grade	Club	1	2	3	4	Wins	Pts	Pos
1	DIOME Grayden	3K	Tritton	XX		10	10	2	20	2
2	LI Alexander	?	Ippon	10	XX	10	10	3	30	1
3	HUANG Matthew	4K	Regina Y			XX	10	1	10	3
4	TAMURA Grayson	3K	Lethbridge				XX	0	0	4

## Matches

Match	White			Blue	Result	Time	Code
D-63	DIOME Grayden	1	2	LI Alexander	0 - 10	1:45	WIP
D-64	HUANG Matthew	3	4	TAMURA Grayson	10 - 0	1:33	IPO
D-71	DIOME Grayden	1	3	HUANG Matthew	10 - 0	0:56	WIP
D-72	LI Alexander	2	4	TAMURA Grayson	10 - 0	1:27	IPO
D-76	DIOME Grayden	1	4	TAMURA Grayson	10 - 0	3:00	GSI
D-77	LI Alexander	2	3	HUANG Matthew	10 - 0	1:16	WIP

## Results

Pos	Name
1	LI Alexander, Ippon
2	DIOME Grayden, Tritton
3	HUANG Matthew, Regina Y

# U14M -35 kg

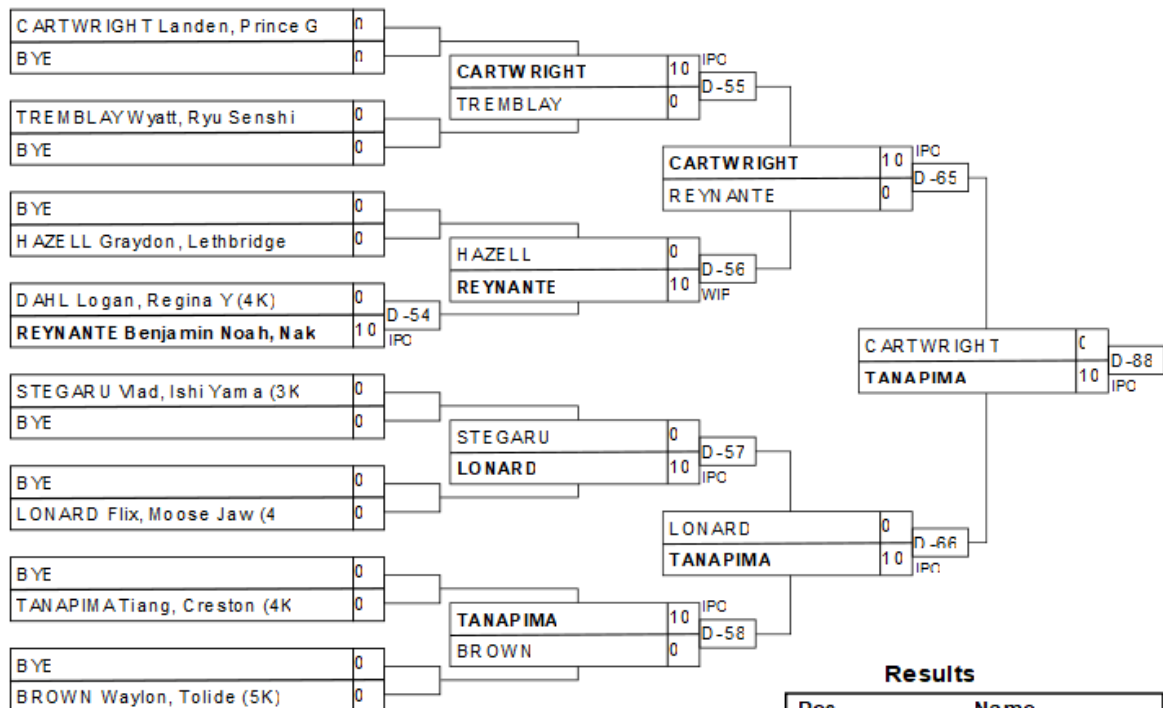

## Results

Pos	Name
1	TANAPIMA Tiang, Creston
2	CARTWRIGHT Landen, Princ
3	REYNANTE Benjamin Noah,
3	LONARD Flix, M oose Jaw

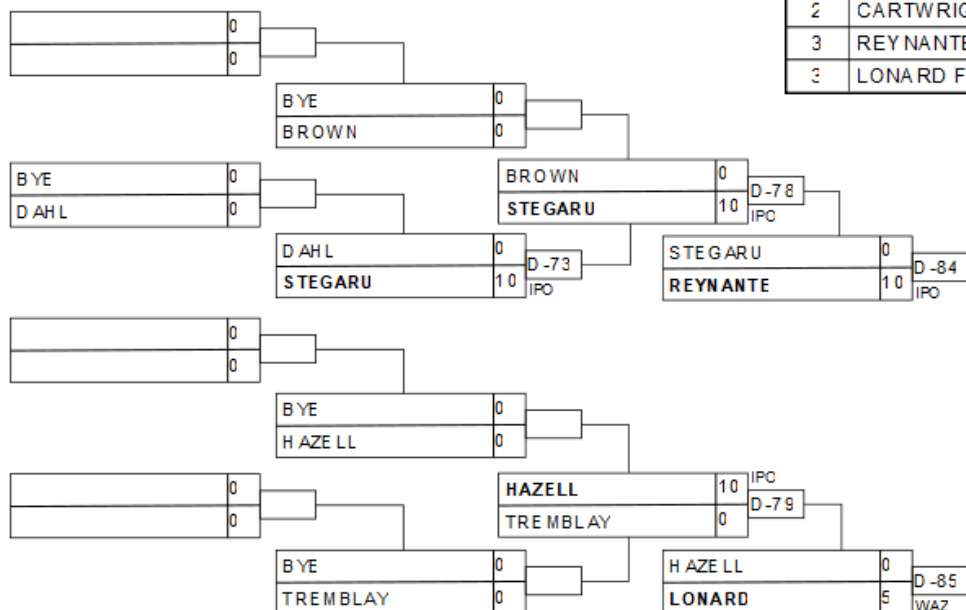

# U14M -38 kg

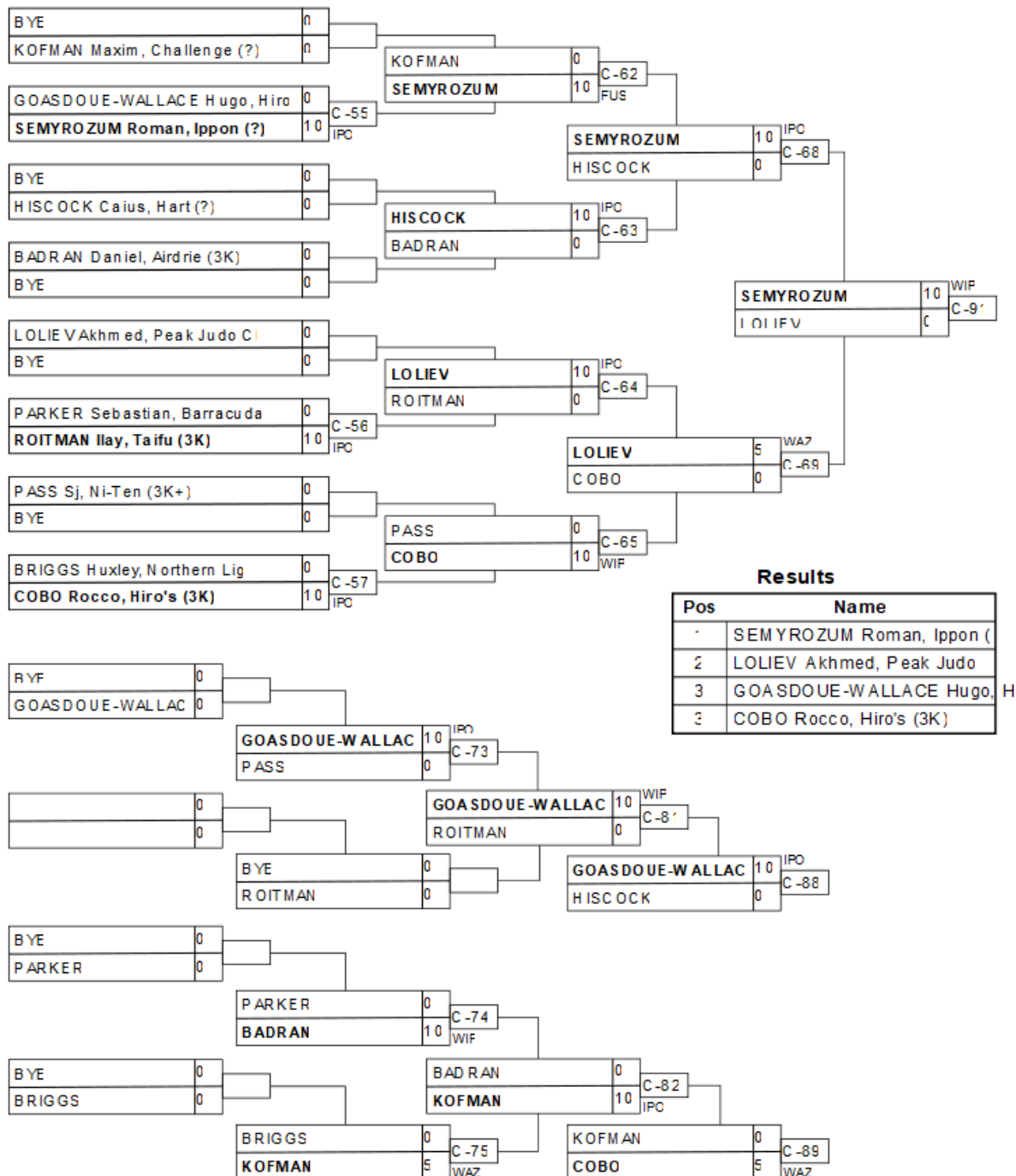

# U14M -42 kg

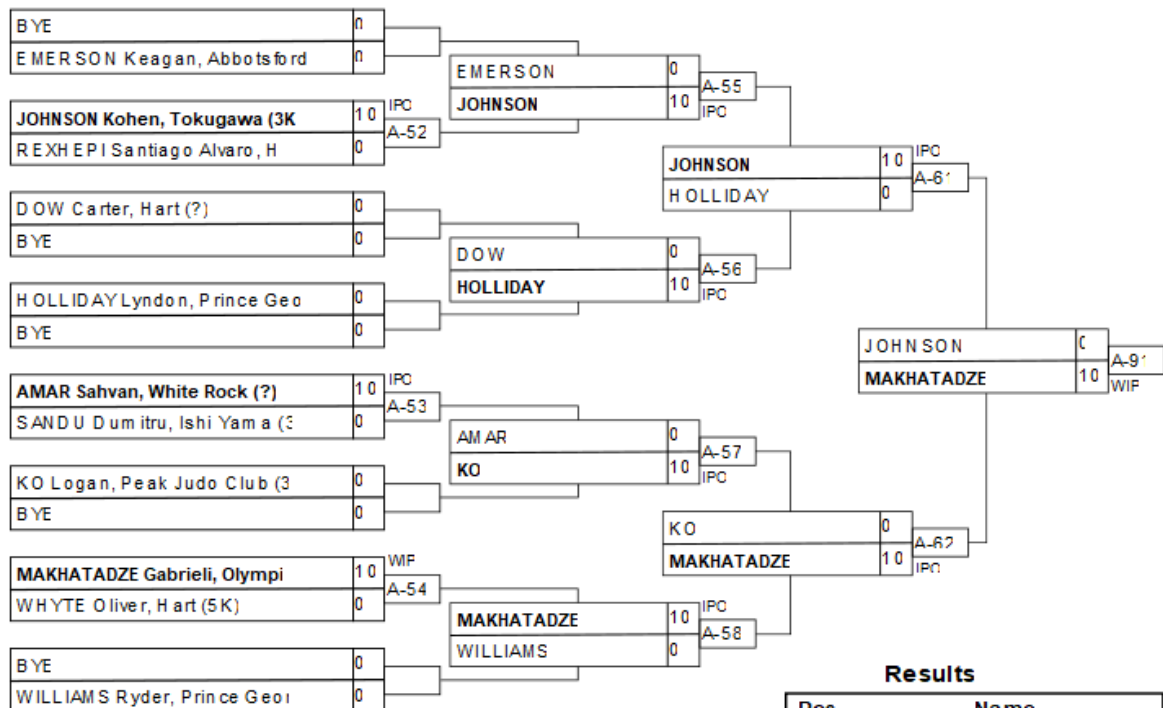

## Results

Pos	Name
1	MAKHATADZE Gabrieli, Oly
2	JOHNSON Kohen, Tokugawa
3	REXHEPI Santiago Alvaro
3	KO Logan, Peak Judo Club

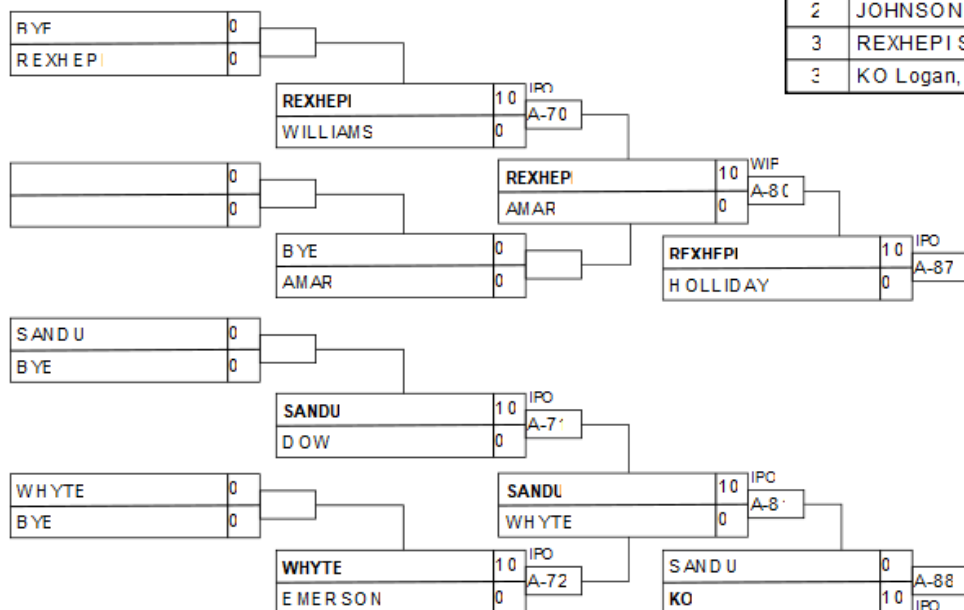

# U14M -46 kg

## Competitors A

#	Name	Grade	Club	1	2	3	4	Wins	Pts	Pos
1	PAMPOLINA Bennet	1K	Nakamura	XX	10	10	10	3	30	1
2	KRATKY Owen	3K	St. Albert		XX			0	0	4
3	TERRY Seann	4K	Moose Jaw		5	XX		1	5	3
4	DILIO Ethan	?	Kodokwai		10	10	XX	2	20	2

## Pool A

Match	White	Blue	Result	Time	Code
A-64	PAMPOLINA Bennet	1 2 KRATKY Owen	10 - 0	0:22	IPO
A-65	TERRY Seann	3 4 DILIO Ethan	0 - 10	0:17	IPO
A-74	PAMPOLINA Bennet	1 3 TERRY Seann	10 - 0	0:31	WIP
A-75	KRATKY Owen	2 4 DILIO Ethan	0 - 10	0:04	IPO
A-83	PAMPOLINA Bennet	1 4 DILIO Ethan	10 - 0	3:00	IPO
A-84	KRATKY Owen	2 3 TERRY Seann	0 - 5	3:00	WAZ

## Competitors B

#	Name	Grade	Club	5	6	7	Wins	Pts	Pos
5	GRUJIC Luka	4K	Medicine Hat	XX			0	0	3
6	TEMIRBAEV Amir	?	Peak Judo Club	10	XX	10	2	20	1
7	GRISALES Jhonathon	3K	GP Martial Arts	10		XX	1	10	2

## Pool B

Match	White	Blue	Result	Time	Code
A-66	GRUJIC Luka	5 6 TEMIRBAEV Amir	0 - 10	0:09	IPO
A-76	GRUJIC Luka	5 7 GRISALES Jhonathon	0 - 10	0:14	IPO
A-85	TEMIRBAEV Amir	6 7 GRISALES Jhonathon	10 - 0	1:25	IPO

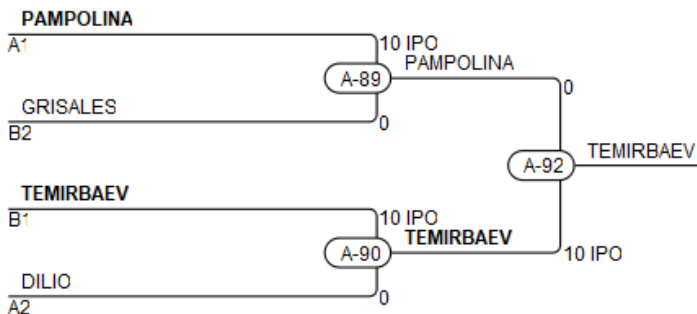

## Results

Pos	Name
1	TEMIRBAEV Amir, Peak Judo Club
2	PAMPOLINA Bennet, Nakamura
3	GRISALES Jhonathon, GP Martial Arts
3	DILIO Ethan, Kodokwai

# U14M -50 kg

## Competitors A

#	Name	Grade	Club	1	2	3	4	Wins	Pts	Pos
1	COLNEY John	3K+	Kodokwai	XX	10		10	2	20	2
2	CLARK James	3K	Steveston		XX			0	0	4
3	ALIZADA Jasur	3K	Olympic	10	10	XX	10	3	30	1
4	HEDSTROM Jesse-Castor	3K	Prince George		10		XX	1	10	3

## Pool A

Match	White		Blue	Result	Time	Code	
B-62	COLNEY John	1	2	CLARK James	10 - 0	2:33	WIP
B-63	ALIZADA Jasur	3	4	HEDSTROM Jesse-Castor	10 - 0	1:20	IPO
B-71	COLNEY John	1	3	ALIZADA Jasur	0 - 10	0:44	IPO
B-72	CLARK James	2	4	HEDSTROM Jesse-Castor	0 - 10	2:30	IPO
B-79	COLNEY John	1	4	HEDSTROM Jesse-Castor	10 - 0	3:00	IPO
B-80	CLARK James	2	3	ALIZADA Jasur	0 - 10	0:18	IPO

## Competitors B

#	Name	Grade	Club	5	6	7	Wins	Pts	Pos
5	STEIGER Dawson	3D	Prince George	XX	10		1	10	2
6	TABOULCHANAS Alexander	3K	Lethbridge		XX		0	0	3
7	MCCARTHY Dominic	3K	GP Martial Arts	10	10	XX	2	20	1

## Pool B

Match	White		Blue	Result	Time	Code	
B-64	STEIGER Dawson	5	6	TABOULCHANAS Alexander	10 - 0	0:50	WIP
B-73	STEIGER Dawson	5	7	MCCARTHY Dominic	0 - 10	0:40	IPO
B-81	TABOULCHANAS Alexander	6	7	MCCARTHY Dominic	0 - 10	1:55	WIP

### ALIZADA

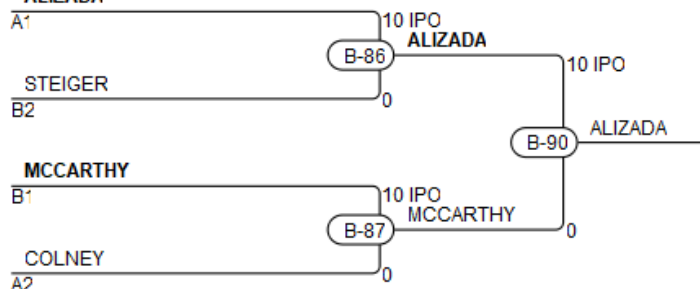

## Results

Pos	Name
1	ALIZADA Jasur, Olympic
2	MCCARTHY Dominic, GP Martial Arts
3	STEIGER Dawson, Prince George
3	COLNEY John, Kodokwai

# U14M -55 kg

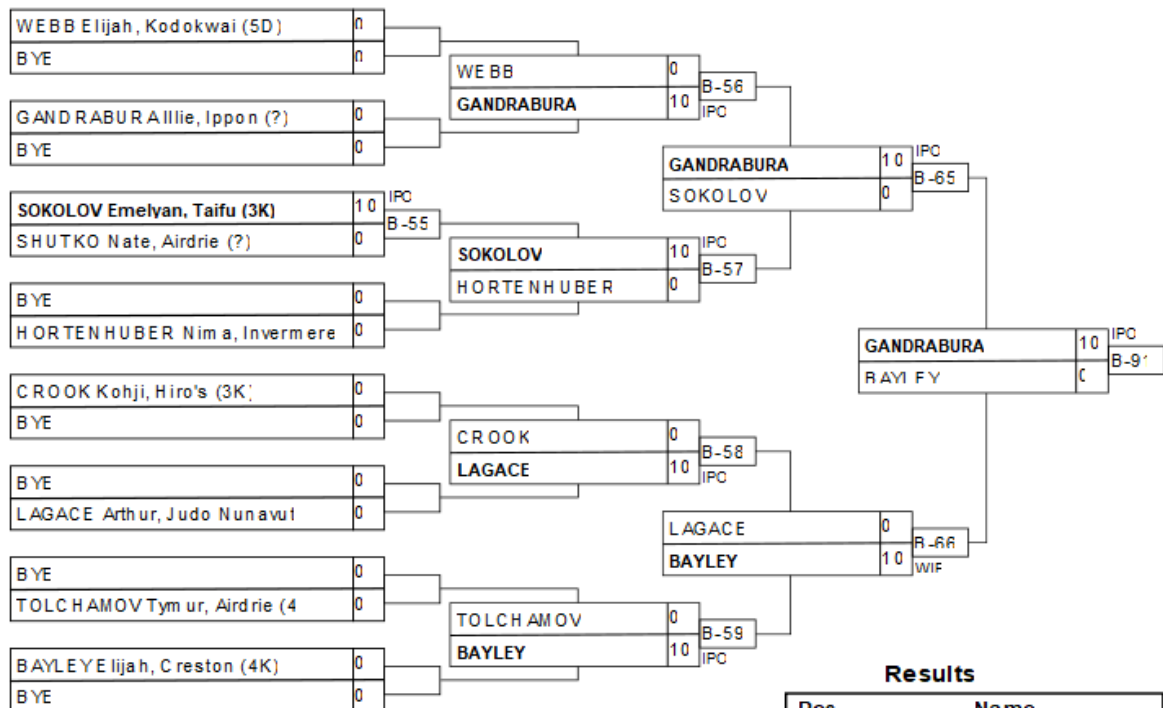

## Results

Pos	Name
1	GANDRABURA Illie, Ippon
2	BAYLEY Elijah, Creston (
3	SOKOLOV Emelyan, Taifu (
3	WEBB Elijah, Kodokwai (5

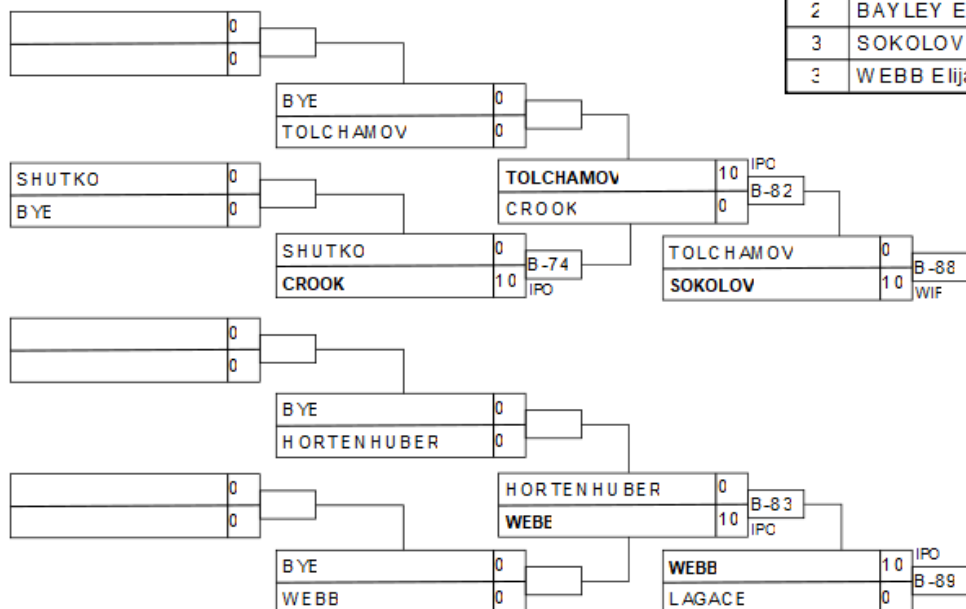



# U14M -60 kg

## Competitors

#	Name	Grade	Club	1	2	3	Wins	Pts	Pos
1	ASGARZADEH Davud	5K	Kodokwai	XX		10	1	10	2
2	GREGORY Drake	?	Lethbridge	10	XX	10	2	20	1
3	ISMAYILOV Mir-Maleek	5K	Challenge			XX	0	0	3

## Matches

Match	White			Blue	Result	Time	Code
A-63	ASGARZADEH Davud	1	2	GREGORY Drake	0 - 10	0:50	IPO
A-73	ASGARZADEH Davud	1	3	ISMAYILOV Mir-Maleek	10 - 0	0:00	FUS
A-82	GREGORY Drake	2	3	ISMAYILOV Mir-Maleek	10 - 0	1:02	WIP

## Results

Pos	Name
1	GREGORY Drake, Lethbridge
2	ASGARZADEH Davud, Kodokwai

# U14M -66 kg

## Competitors

#	Name	Grade	Club	1	2	1	2	1	2	Wins	Pts	Pos
1	YAR Arshia	5K	Kodokwai	XX		XX		XX		0	0	2
2	OUDOVIKINE Daniel	?	Taifu	10	XX	10	XX		XX	2	20	1

## Matches

Match	White			Blue	Result	Time	Code
A-67	YAR Arshia	1	2	OUDOVIKINE Daniel	0 - 10	1:06	WIP
A-77	OUDOVIKINE Daniel	2	1	YAR Arshia	10 - 0	1:25	WIP
A-86	YAR Arshia	1	2	OUDOVIKINE Daniel			

## Results

Pos	Name
1	OUDOVIKINE Daniel, Taifu

# U14M +66 kg

## Competitors

#	Name	Grade	Club	1	2	3	4	Wins	Pts	Pos
1	HRYNIW Marcus	3K	Tolide	XX		10		1	10	3
2	STERBA Rowen	4K	Lethbridge	10	XX	10		2	20	2
3	BICKFORD Alexander	3K	Hart			XX		0	0	4
4	SOFTIC Asher	4K+	Medicine Hat	10	10	10	XX	3	30	1

## Matches

Match	White			Blue	Result	Time	Code
C-70	HRYNIW Marcus	1	2	STERBA Rowen	0 - 10	0:18	WIP
C-71	BICKFORD Alexander	3	4	SOFTIC Asher	0 - 10	0:27	IPO
C-76	HRYNIW Marcus	1	3	BICKFORD Alexander	10 - 0	0:01	FUS
C-77	STERBA Rowen	2	4	SOFTIC Asher	0 - 10	0:23	WIP
C-83	HRYNIW Marcus	1	4	SOFTIC Asher	0 - 10	0:14	IPO
C-84	STERBA Rowen	2	3	BICKFORD Alexander	10 - 0	0:01	FUS

## Results

Pos	Name
1	SOFTIC Asher, Medicine Hat
2	STERBA Rowen, Lethbridge
3	HRYNIW Marcus, Tolide

# U18F -48 kg

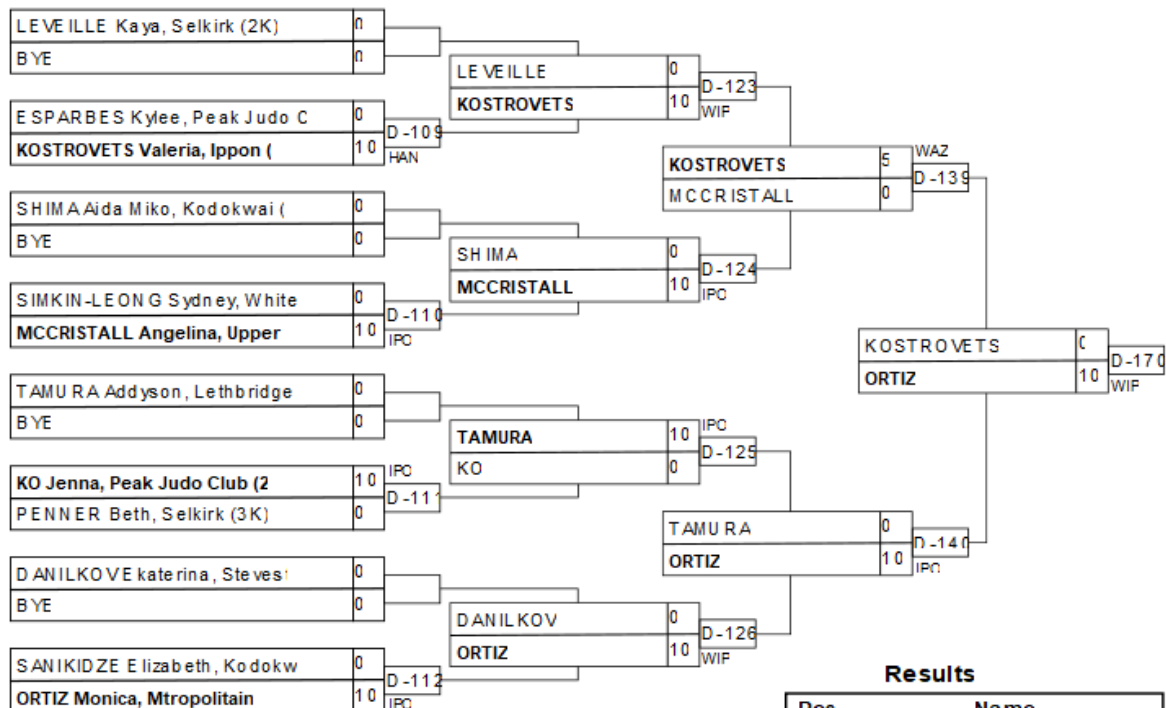

## Results

Pos	Name
1	ORTIZ Monica, M tropolit
2	KOSTROVETS Valeria, Ippo
3	DANILKOV E kate rina , Ste ves
3	TAMURA Addyson, Lethbrid

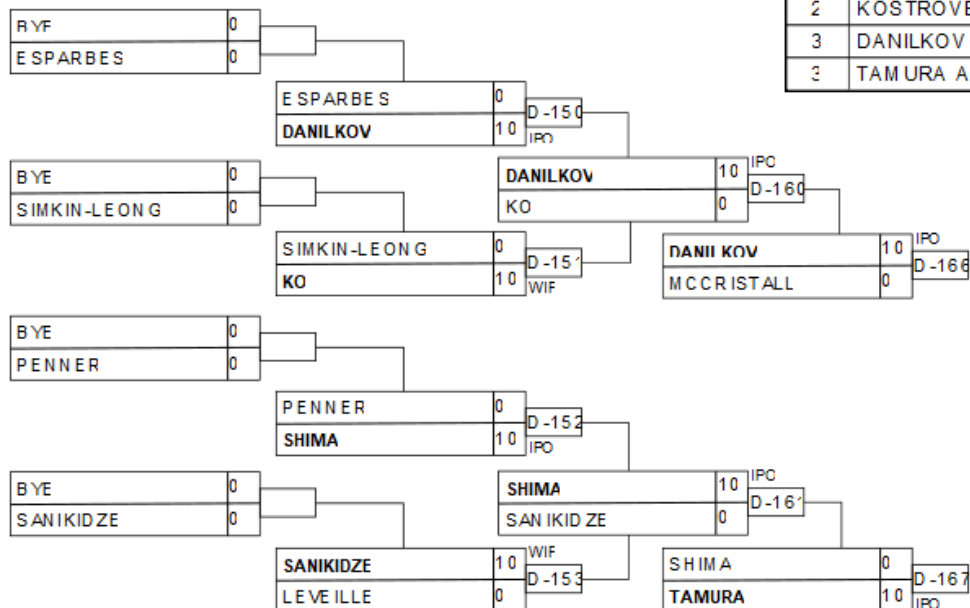

# U18F -52 kg

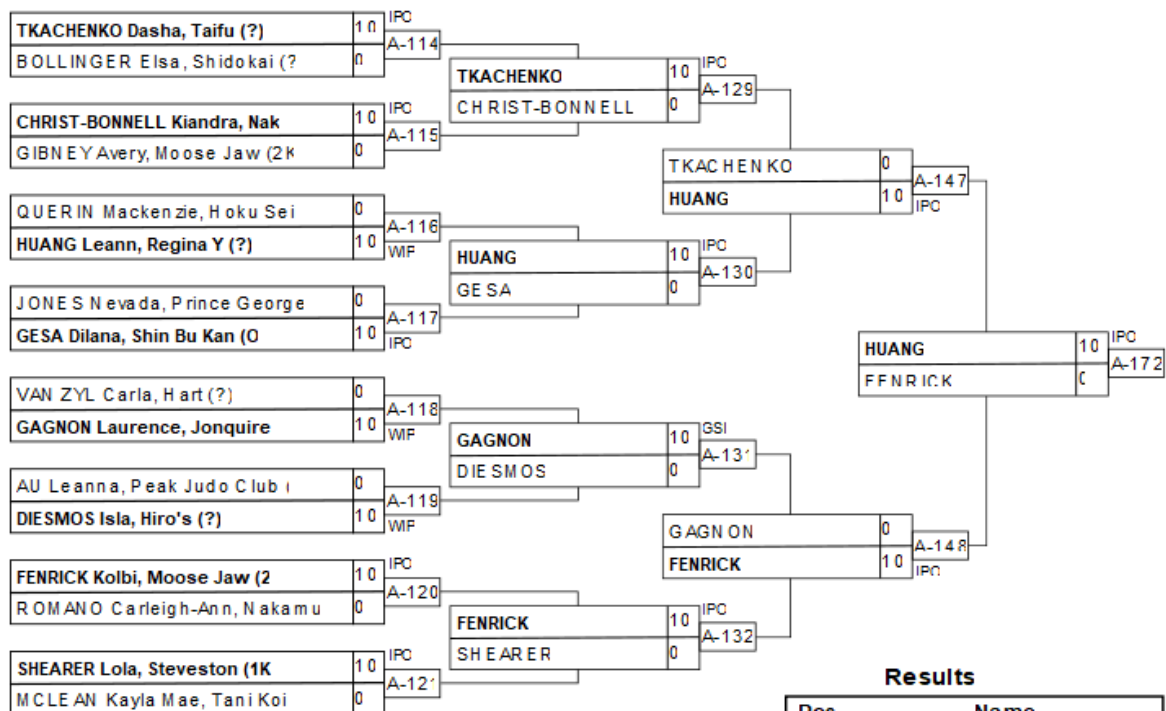

## Results

Pos	Name
1	HUANG Leann, Regina Y (?)
2	FENRICK Kolbi, Moose Jaw
3	TKACHENKO Dasha, Taifu (
3	GAGNON Laurence, Jonqui

# U18F -57 kg

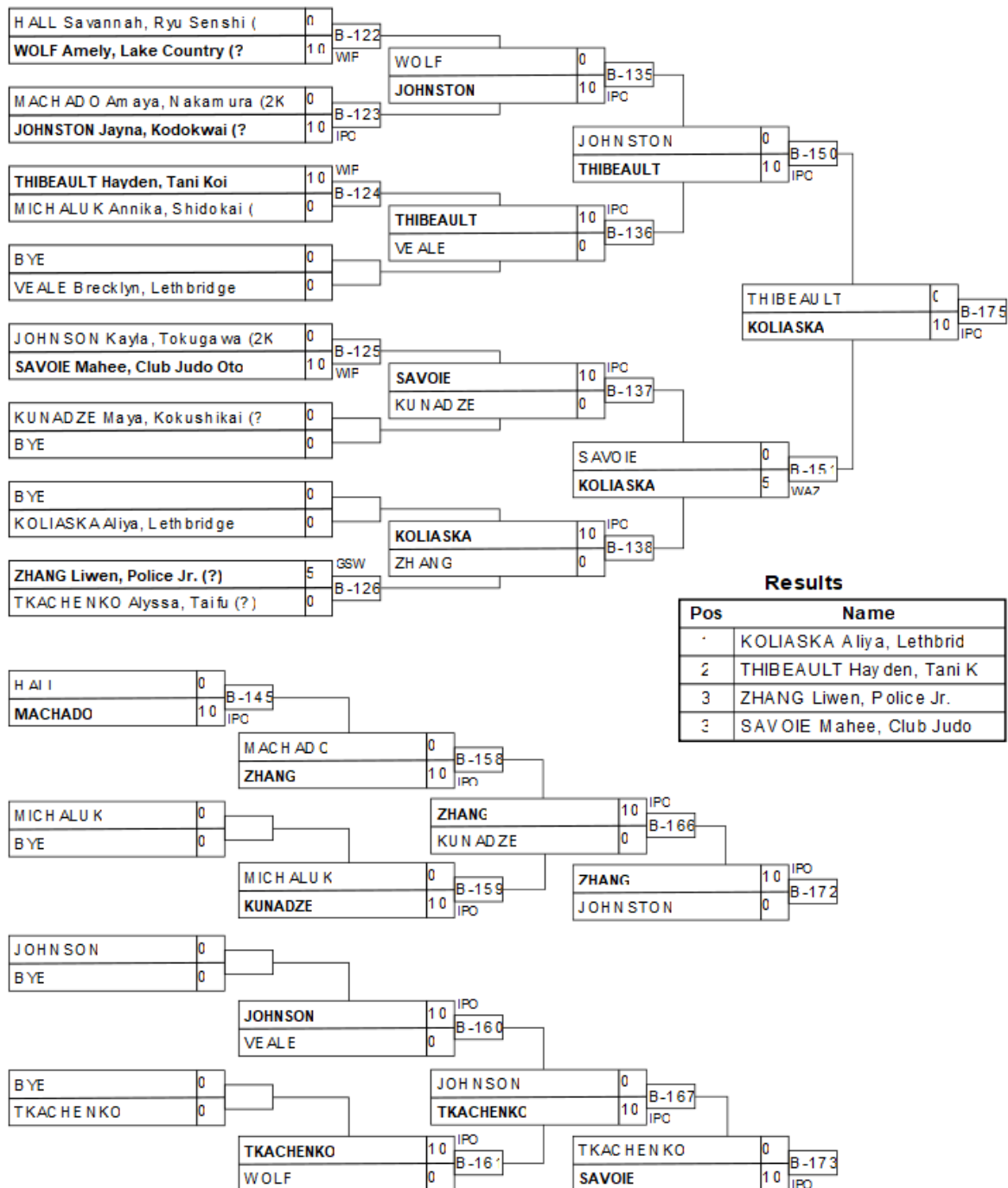

# U21F -63 kg

## Competitors

#	Name	Grade	Club	1	2	3	4	5	Wins	Pts	Pos
1	GRISALES Michelle	1D	U of A	XX			10		1	10	4
2	MACDONALD Meadow	?	Lethbridge	10	XX		10	10	3	30	2
3	WESTLAKE Kiera	1D	Lethbridge	10	10	XX	10	10	4	40	1
4	DAHL Alexis	2K	Regina Y				XX		0	0	5
5	EKOSKY Sarah	1D	Selkirk	10			10	XX	2	20	3

## Matches

Match	White			Blue	Result	Time	Code
B-176	DAHL Alexis	4	5	EKOSKY Sarah	0 - 10	0:25	WIP
B-177	GRISALES Michelle	1	2	MACDONALD Meadow	0 - 10	3:14	IPO
B-178	WESTLAKE Kiera	3	4	DAHL Alexis	10 - 0	0:44	IPO
B-179	GRISALES Michelle	1	5	EKOSKY Sarah	0 - 10	0:19	IPO
B-185	MACDONALD Meadow	2	3	WESTLAKE Kiera	0 - 10	1:54	WIP
B-186	GRISALES Michelle	1	4	DAHL Alexis	10 - 0	0:21	WIP
B-192	WESTLAKE Kiera	3	5	EKOSKY Sarah	10 - 0	7:55	HAN
B-193	MACDONALD Meadow	2	4	DAHL Alexis	10 - 0	0:36	IPO
B-199	GRISALES Michelle	1	3	WESTLAKE Kiera	0 - 10	1:45	IPO
B-200	MACDONALD Meadow	2	5	EKOSKY Sarah	10 - 0	0:00	IPO

## Results

Pos	Name
1	WESTLAKE Kiera, Lethbridge
2	MACDONALD Meadow, Lethbridge
3	EKOSKY Sarah, Selkirk
4	GRISALES Michelle, U of A

# U21F -70 kg

## Competitors

#	Name	Grade	Club	1	2	3	Wins	Pts	Pos
1	LEFORT Alexandria	1D	Sheffield	XX			0	0	3
2	BIRON Laurence	1K	Varenes	10	XX	10	2	20	1
3	VILLA Rebecca	1K	Nakamura	10		XX	1	10	2

## Matches

Match	White			Blue	Result	Time	Code
D-184	LEFORT Alexandria	1	2	BIRON Laurence	0 - 10	0:00	IPO
D-187	LEFORT Alexandria	1	3	VILLA Rebecca	0 - 10	0:00	FUS
D-193	BIRON Laurence	2	3	VILLA Rebecca	10 - 0	1:00	WIP

## Results

Pos	Name
1	BIRON Laurence, Varenes
2	VILLA Rebecca, Nakamura



# U21M -100 kg

## Competitors

#	Name	Grade	Club	1	2	1	2	1	2	Wins	Pts	Pos
1	ILIFFE Jonathan	?	Lake Country	XX		XX		XX		0	0	2
2	AKBASHEV Michael	1D	BP Judo club	5	XX	10	XX		XX	2	15	1

## Matches

Match	White			Blue	Result	Time	Code
B-180	ILIFFE Jonathan	1	2	AKBASHEV Michael	0 - 5	0:30	WAZ
B-187	AKBASHEV Michael	2	1	ILIFFE Jonathan	10 - 0	1:25	WIP
B-194	ILIFFE Jonathan	1	2	AKBASHEV Michael			

## Results

Pos	Name
1	AKBASHEV Michael, BP Judo club

# U21M -60 kg

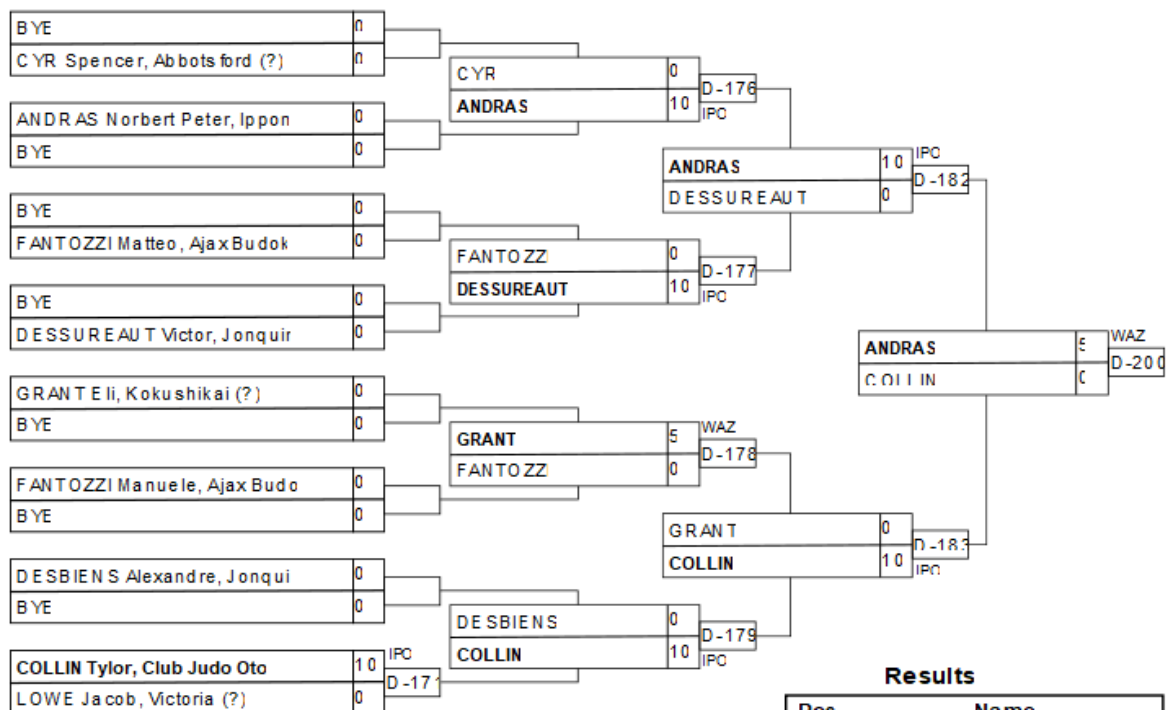

## Results

Pos	Name
1	ANDRAS Norbert Peter, Ip
2	COLLIN Tylor, Club Judo
3	DESSUREAUT Victor, Jonqu
3	FANTOZZI M atteo, Ajax Bu

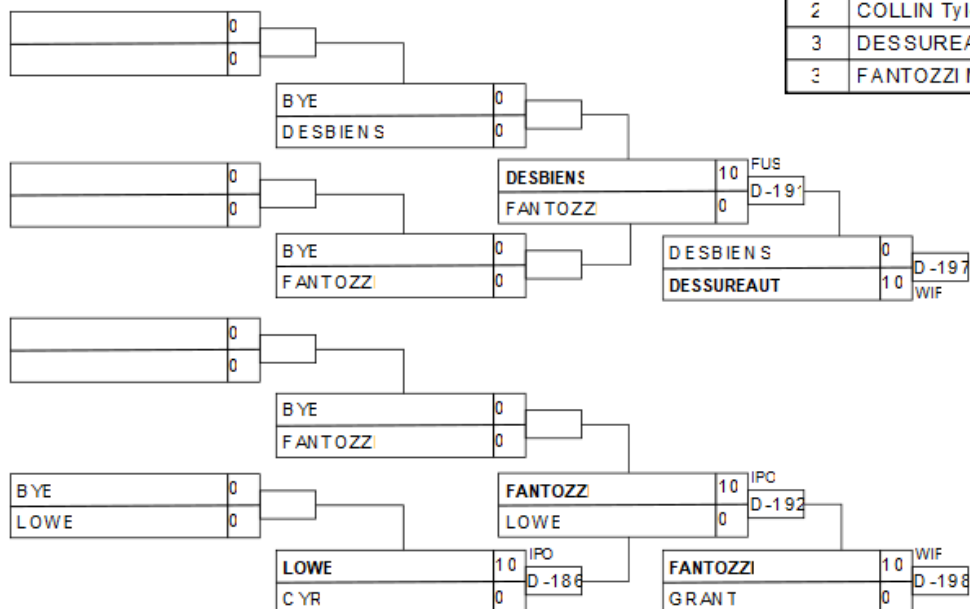

# U21M -66 kg

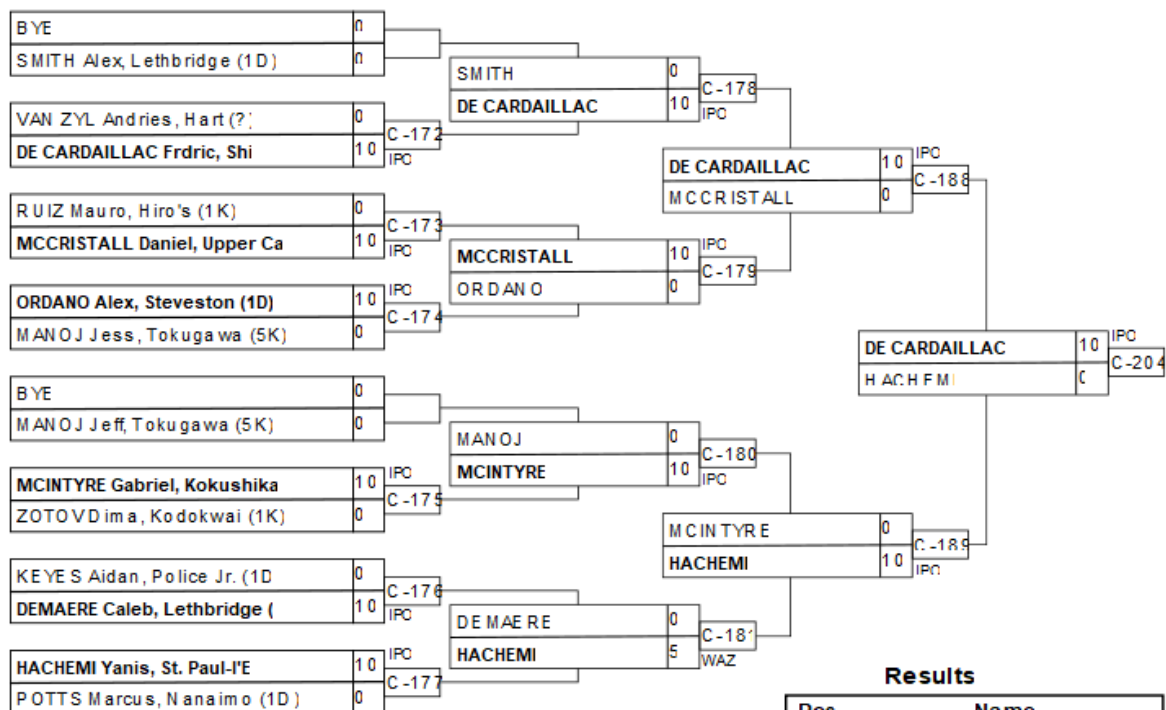

## Results

Pos	Name
1	DE CARDAILLAC Frdric,
2	HACHEMI Yanis, St. Paul-
3	MCCRISTALL Daniel, Upper
3	ORDANO Alex, Steveston (

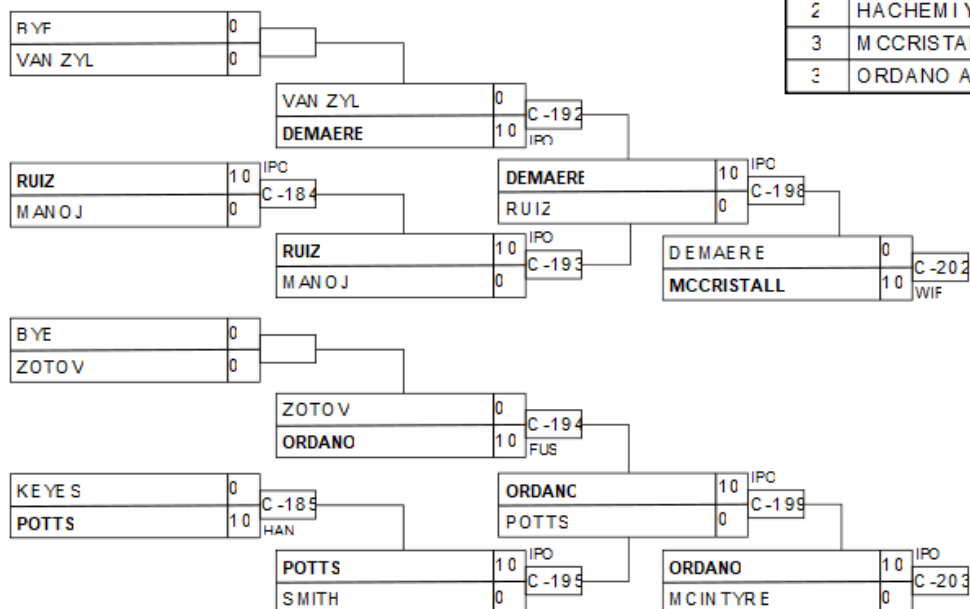

# U21M -73 kg

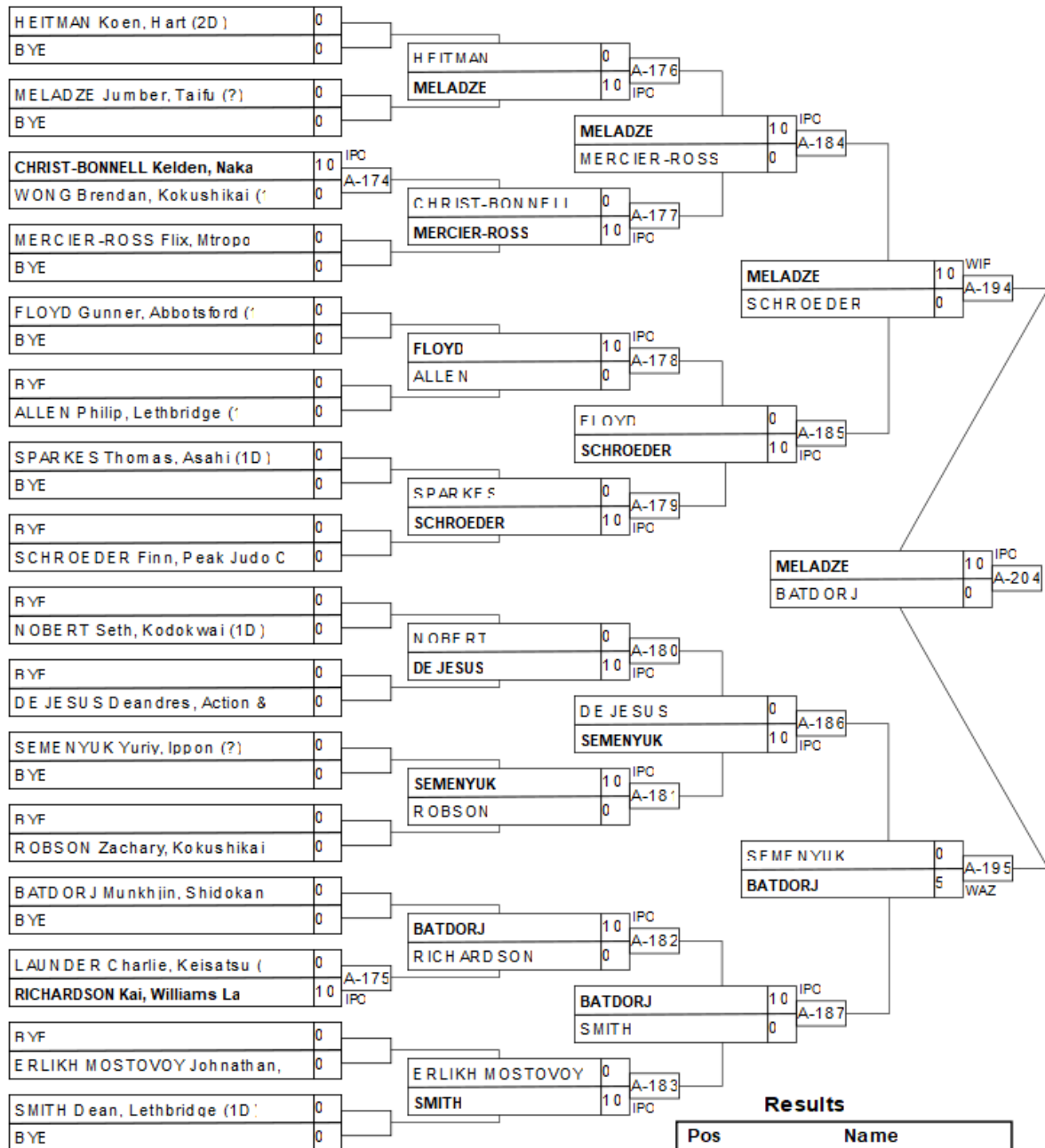

## Results

Pos	Name
1	MELADZE Jumber, Taifu (?)
2	BATDORJ Munkhjin, Shidok
3	SCHROEDER Finn, Peak Jud
3	SEMENYUK Yuriy, Ippon (?)

# U21M -81 kg

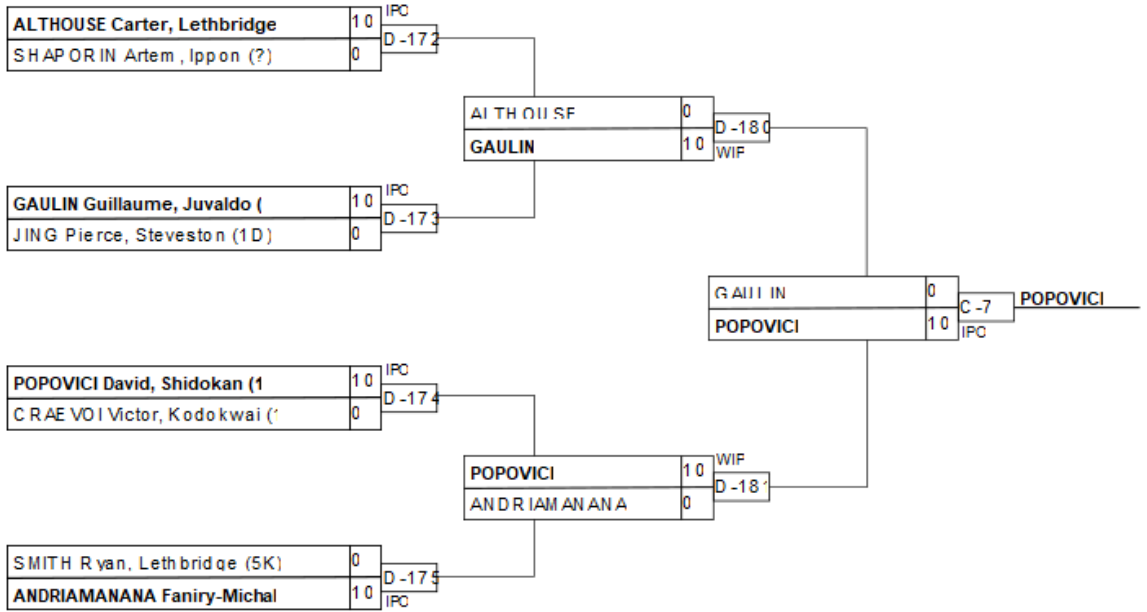

## Results

Pos	Name
1	POPOVICI David, Shidokan
2	GAULIN Guillaume, Juvald
3	CRAEVOI Victor, Kodokwai
3	ANDRIAMANANA Faniry-Michel

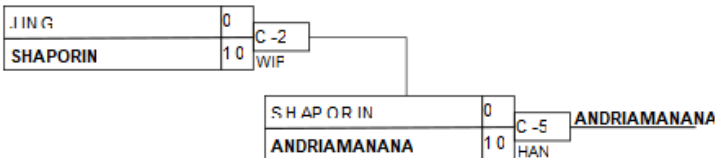
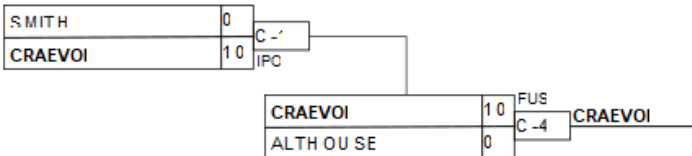

# U21M -90 kg

## Competitors

#	Name	Grade	Club	1	2	3	4	5	Wins	Pts	Pos
1	GARAND Alec	?	Zenshin	XX		10	10	10	3	30	
2	VAN NIEUWLAND Luuk	1K	Nippon judo Achterhoek	5	XX	10	10	10	4	35	
3	LUCHKIN Nick	1K	Challenge			XX	10		1	10	
4	GODBOUT Xavier	?	Hiro's				XX	10	1	10	
5	KURPJUWEIT Judah	2K	Medicine Hat					XX			

## Matches

Match	White			Blue	Result	Time	Code
C-182	GODBOUT Xavier	4	5	KURPJUWEIT Judah	10 - 0	3:01	HAN
C-183	GARAND Alec	1	2	VAN NIEUWLAND Luuk	0 - 5	4:00	WAZ
C-186	LUCHKIN Nick	3	4	GODBOUT Xavier	10 - 0	2:26	WIP
C-187	GARAND Alec	1	5	KURPJUWEIT Judah	10 - 0	1:23	IPO
C-190	VAN NIEUWLAND Luuk	2	3	LUCHKIN Nick	10 - 0	1:33	IPO
C-191	GARAND Alec	1	4	GODBOUT Xavier	10 - 0	1:14	IPO
C-196	LUCHKIN Nick	3	5	KURPJUWEIT Judah			
C-197	VAN NIEUWLAND Luuk	2	4	GODBOUT Xavier	10 - 0	1:58	IPO
C-200	GARAND Alec	1	3	LUCHKIN Nick	10 - 0	1:08	KIK
C-201	VAN NIEUWLAND Luuk	2	5	KURPJUWEIT Judah	10 - 0	0:00	KIK

## Results

Pos	Name

# U21M +100 kg

## Competitors

#	Name	Grade	Club	1	2	3	Wins	Pts	Pos
1	CROOK Shion	1D	Hiro's	XX	10		1	10	2
2	VELASQUEZ KASAP Abel	?	Police Jr.		XX		0	0	3
3	CROSS Nick	1K	Tritton	10	10	XX	2	20	1

## Matches

Match	White			Blue	Result	Time	Code
C-141	CROOK Shion	1	2	VELASQUEZ KASAP Abel	10 - 0	0:01	FUS
C-155	CROOK Shion	1	3	CROSS Nick	0 - 10	0:23	IPO
C-165	VELASQUEZ KASAP Abel	2	3	CROSS Nick	0 - 10	0:34	IPO

## Results

Pos	Name
1	CROSS Nick, Tritton
2	CROOK Shion, Hiro's

# VETM30 -81 kg

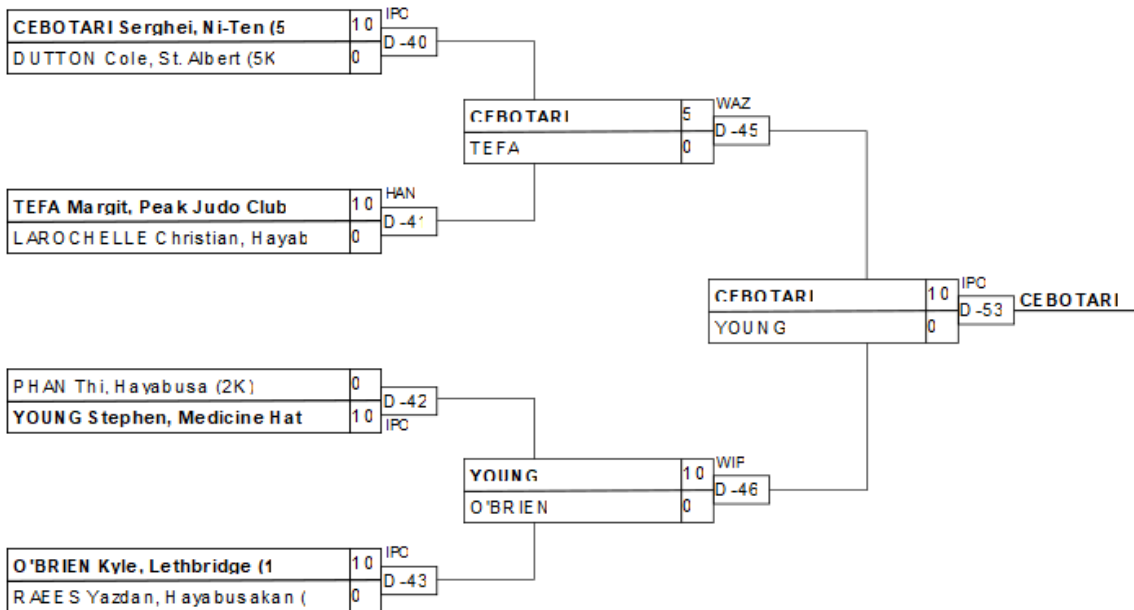

## Results

Pos	Name
1	CEBOTARI Serghei, Ni-Ten
2	YOUNG Stephen, Medicine
3	TEFA Margit, Peak Judo C
3	O'BRIEN Kyle, Lethbridge

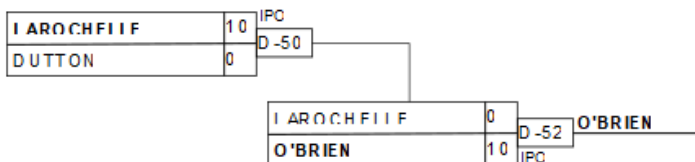
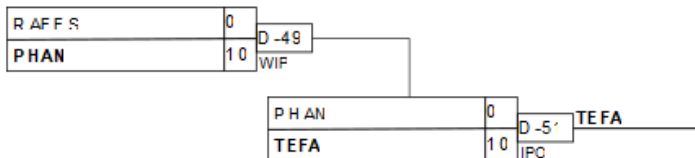



# VETM30 +81 kg

## Competitors

#	Name	Grade	Club	1	2	3	Wins	Pts	Pos
1	PAXMAN Eric	?	U of A	XX			0	0	3
2	WHITE Justin	1K	Airdrie	10	XX	10	2	20	1
3	MURPHY Michael	1K	Fudoshin	10		XX	1	10	2

## Matches

Match	White			Blue	Result	Time	Code
B-43	PAXMAN Eric	1	2	WHITE Justin	0 - 10	0:33	IPO
B-47	PAXMAN Eric	1	3	MURPHY Michael	0 - 10	0:51	IPO
B-51	WHITE Justin	2	3	MURPHY Michael	10 - 0	0:40	WIP

## Results

Pos	Name
1	WHITE Justin, Airdrie
2	MURPHY Michael, Fudoshin

# VETM35 -81 kg

## Competitors

#	Name	Grade	Club	1	2	3	Wins	Pts	Pos
1	CROWELL Kyle	1D	St. Albert	XX	10	10	2	20	1
2	MACLEOD David	2K	Hayabusa		XX	10	1	10	2
3	KRICHKOWSKI Andrew	4K	BP Judo club			XX	0	0	3

## Matches

Match	White			Blue	Result	Time	Code
A-44	CROWELL Kyle	1	2	MACLEOD David	10 - 0	0:51	IPO
A-47	CROWELL Kyle	1	3	KRICHKOWSKI Andrew	10 - 0	1:05	IPO
A-50	MACLEOD David	2	3	KRICHKOWSKI Andrew	10 - 0	1:03	IPO

## Results

Pos	Name
1	CROWELL Kyle, St. Albert
2	MACLEOD David, Hayabusa

# VETM35 +81 kg

## Competitors

#	Name	Grade	Club	1	2	3	Wins	Pts	Pos
1	DAVIES Lance	1K	Kodokwai	XX			0	0	3
2	KINGSTON Robert	2D	Ryu Senshi	10	XX	10	2	20	1
3	LUPANCIUC Dumitru	1K	Hayabusakan	10		XX	1	10	2

## Matches

Match	White			Blue	Result	Time	Code
D-44	DAVIES Lance	1	2	KINGSTON Robert	0 - 10	4:41	GSW
D-47	DAVIES Lance	1	3	LUPANCIUC Dumitru	0 - 10	1:08	IPO
D-48	KINGSTON Robert	2	3	LUPANCIUC Dumitru	10 - 0	1:18	IPO

## Results

Pos	Name
1	KINGSTON Robert, Ryu Senshi
2	LUPANCIUC Dumitru, Hayabusakan

# VETM40 -81 kg

## Competitors

#	Name	Grade	Club	1	2	1	2	1	2	Wins	Pts	Pos
1	MCHALE Brian	1K	Takahashi	XX		XX		XX		0	0	2
2	ZALESKIKH Ivan	1K	St. Albert	10	XX	10	XX		XX	2	20	1

## Matches

Match	White			Blue	Result	Time	Code
A-43	MCHALE Brian	1	2	ZALESKIKH Ivan	0 - 10	0:10	IPO
A-46	ZALESKIKH Ivan	2	1	MCHALE Brian	10 - 0	0:31	IPO
A-49	MCHALE Brian	1	2	ZALESKIKH Ivan			

## Results

Pos	Name
1	ZALESKIKH Ivan, St. Albert

# VETM40 +81 kg

## Competitors

#	Name	Grade	Club	1	2	1	2	1	2	Wins	Pts	Pos
1	KURPJUWEIT Robin	1K	Medicine Hat	XX		XX		XX		0	0	2
2	PIVOVAR Mark	2D	Kodokwai	10	XX	10	XX		XX	2	20	1

## Matches

Match	White			Blue	Result	Time	Code
C-42	KURPJUWEIT Robin	1	2	PIVOVAR Mark	0 - 10	0:43	IPO
C-46	PIVOVAR Mark	2	1	KURPJUWEIT Robin	10 - 0	1:10	IPO
C-50	KURPJUWEIT Robin	1	2	PIVOVAR Mark			

## Results

Pos	Name
1	PIVOVAR Mark, Kodokwai

# VETM45 -66 kg

## Competitors

#	Name	Grade	Club	1	2	1	2	1	2	Wins	Pts	Pos
1	GEPHTER Sheldon	2D	BP Judo club	XX		XX		XX		0	0	2
2	CHIN Justin	4D	Kodokwai	10	XX	10	XX		XX	2	20	1

## Matches

Match	White			Blue	Result	Time	Code
A-45	GEPHTER Sheldon	1	2	CHIN Justin	0 - 10	0:13	IPO
A-48	CHIN Justin	2	1	GEPHTER Sheldon	10 - 0	0:50	IPO
A-51	GEPHTER Sheldon	1	2	CHIN Justin			

## Results

Pos	Name
1	CHIN Justin, Kodokwai

# VETM45 -81 kg

## Competitors A

#	Name	Grade	Club	1	2	3	Wins	Pts	Pos
1	SAINT-MARTIN Marc	1D	St. Albert	XX	10		1	10	2
2	BRAR Navdeep	1K	Abbotsford		XX		0	0	3
3	SMILEY Christopher	2D	Lake Country	10	10	XX	2	20	1

## Pool A

Match	White	Blue	Result	Time	Code
C-40	SAINT-MARTIN Marc	BRAR Navdeep	10 - 0	0:01	FUS
C-44	SAINT-MARTIN Marc	SMILEY Christopher	0 - 10	4:00	HAN
C-48	BRAR Navdeep	SMILEY Christopher	0 - 10	0:59	IPO

## Competitors B

#	Name	Grade	Club	4	5	6	Wins	Pts	Pos
4	KEIRSTEAD John	1D	Shidokai	XX	10		1	10	2
5	BRIGGS Bernard	2K	Northern Lights		XX		0	0	3
6	ORTIZ Ludwing	5D	Mtropolitain	10	10	XX	2	20	1

## Pool B

Match	White	Blue	Result	Time	Code
C-41	KEIRSTEAD John	BRIGGS Bernard	10 - 0	0:39	IPO
C-45	KEIRSTEAD John	ORTIZ Ludwing	0 - 10	0:23	WIP
C-49	BRIGGS Bernard	ORTIZ Ludwing	0 - 10	0:22	IPO

### SMILEY

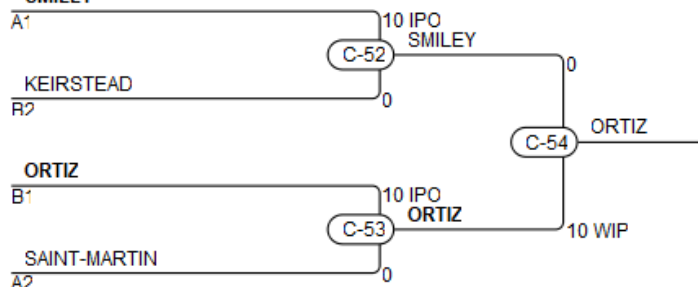

## Results

Pos	Name
1	ORTIZ Ludwing, Mtropolitain
2	SMILEY Christopher, Lake Country
3	KEIRSTEAD John, Shidokai
3	SAINT-MARTIN Marc, St. Albert

# VETM50 -66 kg

## Competitors

#	Name	Grade	Club	1	2	1	2	1	2	Wins	Pts	Pos
1	TAKAHASHI Tim	3D	Lethbridge	XX	10	XX	10	XX		2	20	1
2	URITSKY Mikhail	3D	Kodokwai		XX		XX		XX	0	0	2

## Matches

Match	White			Blue	Result	Time	Code
B-45	TAKAHASHI Tim	1	2	URITSKY Mikhail	10 - 0	1:06	IPO
B-49	URITSKY Mikhail	2	1	TAKAHASHI Tim	0 - 10	1:03	IPO
B-53	TAKAHASHI Tim	1	2	URITSKY Mikhail			

## Results

Pos	Name
1	TAKAHASHI Tim, Lethbridge



# VETM50 +81 kg

## Competitors

#	Name	Grade	Club	1	2	3	Wins	Pts	Pos
1	COUGHLAN Craig	2K	Hiro's	XX			0	0	3
2	ELHEGAZY Hesham	1D	Kodokwai	10	XX	10	2	20	1
3	DEMETER Sandor	1D	Nakamura	10		XX	1	10	2

## Matches

Match	White			Blue	Result	Time	Code
B-44	COUGHLAN Craig	1	2	ELHEGAZY Hesham	0 - 10	0:22	IPO
B-48	COUGHLAN Craig	1	3	DEMETER Sandor	0 - 10	0:17	IPO
B-52	ELHEGAZY Hesham	2	3	DEMETER Sandor	10 - 0	0:28	WIP

## Results

Pos	Name
1	ELHEGAZY Hesham, Kodokwai
2	DEMETER Sandor, Nakamura

# VETW -57 kg

## Competitors

#	Name	Grade	Club	1	2	3	Wins	Pts	Pos
1	GIBNEY Destiny	1D	Moose Jaw	XX			0	0	3
2	LESSARD Caroline	?	Baie-Comeau	10	XX	10	2	20	1
3	SAWADA Miyoko	4K	St. Albert	10		XX	1	10	2

## Matches

Match	White			Blue	Result	Time	Code
C-43	GIBNEY Destiny	1	2	LESSARD Caroline	0 - 10	0:01	FUS
C-47	GIBNEY Destiny	1	3	SAWADA Miyoko	0 - 10	0:01	FUS
C-51	LESSARD Caroline	2	3	SAWADA Miyoko	10 - 0	1:41	WIP

## Results

Pos	Name
1	LESSARD Caroline, Baie-Comeau
2	SAWADA Miyoko, St. Albert

# VETW -70 kg

## Competitors

#	Name	Grade	Club	1	2	3	Wins	Pts	Pos
1	POITRAS Julie	2K	Baie-Comeau	XX			0	0	3
2	GLOVER Mariko	1K	Peak Judo Club	10	XX		1	10	2
3	SOUSA Amanda	1D	Nakamura	10	10	XX	2	20	1

## Matches

Match	White			Blue	Result	Time	Code
B-46	POITRAS Julie	1	2	GLOVER Mariko	0 - 10	0:00	IPO
B-50	POITRAS Julie	1	3	SOUSA Amanda	0 - 10	0:37	IPO
B-54	GLOVER Mariko	2	3	SOUSA Amanda	0 - 10	2:09	IPO

## Results

Pos	Name
1	SOUSA Amanda, Nakamura
2	GLOVER Mariko, Peak Judo Club