

Veterans Ne Waza M -81kg

Competitors/Compétiteurs

#	Name/Nom	Grade	Club	1	2	3	4	5	W/G	Pts	Pos
1	Riccardo FRONTE	Blue	Dyman	XX	20			20	2	40	3
2	Kyle WEBER	Brown	Fudoshin		XX			20	1	20	4
3	Taras SHEVCHENKO	Brown	Champion	20	20	XX		20	3	60	2
4	Jason KETA	Brown	Asahi	20	20	4	XX	20	4	64	1
5	Eugene LI	Brown	Asahi					XX	0	0	5

Matches/Matches

Match	White/Blanc			Blue/Bleu	Res/Rés	Tim/Tmp	Code
D-1	Jason KETA	4	5	Eugene LI	20 - 0	0:51	xxx
D-2	Riccardo FRONTE	1	2	Kyle WEBER	20 - 0	0:54	xxx
D-4	Taras SHEVCHENKO	3	4	Jason KETA	2 - 4	4:00	xxx
D-5	Riccardo FRONTE	1	5	Eugene LI	20 - 0	1:56	xxx
D-9	Kyle WEBER	2	3	Taras SHEVCHENKO	0 - 20	0:17	xxx
D-10	Riccardo FRONTE	1	4	Jason KETA	0 - 20	3:32	xxx
D-15	Taras SHEVCHENKO	3	5	Eugene LI	20 - 0	0:33	xxx
D-16	Kyle WEBER	2	4	Jason KETA	0 - 20	0:20	xxx
D-18	Riccardo FRONTE	1	3	Taras SHEVCHENKO	0 - 20	2:11	xxx
D-19	Kyle WEBER	2	5	Eugene LI	20 - 0	1:46	xxx

Results/Résultats

Pos	Name/Nom
1	Jason KETA, Asahi
2	Taras SHEVCHENKO, Champion
3	Riccardo FRONTE, Dyman
4	Kyle WEBER, Fudoshin

Veterans Ne Waza M -100kg

Competitors/Compétiteurs

#	Name/Nom	Grade	Club	1	2	3	4	W/G	Pts	Pos
1	Greg NEEB	Brown	Asahi	XX	20	6	14	3	40	1
2	Mohammad Monir NAJAFE	Brown	Midtown Judo - Kiyomizuk		XX			0	0	4
3	Jacob SMITH	Sandan	Dyman		20	XX		1	20	3
4	Shawnisty BUDWEG	Shodan	Huntsville		20	20	XX	2	40	2

Matches/Matches

Match	White/Blanc			Blue/Bleu	Res/Rés	Tim/Tmp	Code
E-5	Greg NEEB	1	2	Mohammad Monir NAJAFE	20 - 0	0:57	xxx
E-6	Jacob SMITH	3	4	Shawnisty BUDWEG	0 - 20	0:14	xxx
E-11	Greg NEEB	1	3	Jacob SMITH	6 - 2	4:00	xxx
E-12	Mohammad Monir NAJAFE	2	4	Shawnisty BUDWEG	0 - 20	3:25	xxx
E-16	Greg NEEB	1	4	Shawnisty BUDWEG	14 - 2	4:00	xxx
E-17	Mohammad Monir NAJAFE	2	3	Jacob SMITH	0 - 20	0:00	xxx

Results/Résultats

Pos	Name/Nom
1	Greg NEEB, Asahi
2	Shawnisty BUDWEG, Huntsville
3	Jacob SMITH, Dyman

U12 Male G1

Competitors/Compétiteurs

#	Name/Nom	Grade	Club	1	2	3	4	W/G	Pts	Pos
1	Aslan TYNAROV	Orange	Ippon	XX	10	10	10	3	30	1
2	Aristotelis CHRISTOPOULOS	Orange	Ippon		XX	10	10	2	20	2
3	Ron LITVINOV	Orange	Challenge			XX		0	0	4
4	Christopher RESTREPO	Orange	Kawasaki			10	XX	1	10	3

Matches/Matches

Match	White/Blanc			Blue/Bleu	Res/Rés	Tim/Tmp	Code
C-2	Aslan TYNAROV	1	2	Aristotelis CHRISTOPOULOS	10 - 0	2:00	IPO
C-6	Ron LITVINOV	3	4	Christopher RESTREPO	0 - 10	0:50	IPO
C-10	Aslan TYNAROV	1	3	Ron LITVINOV	10 - 0	0:10	IPO
C-15	Aristotelis CHRISTOPOULOS	2	4	Christopher RESTREPO	10 - 0	0:23	IPO
C-17	Aslan TYNAROV	1	4	Christopher RESTREPO	10 - 0	1:27	WIP
C-20	Aristotelis CHRISTOPOULOS	2	3	Ron LITVINOV	10 - 0	2:00	WIP

Results/Résultats

Pos	Name/Nom
1	Aslan TYNAROV, Ippon
2	Aristotelis CHRISTOPOULOS, Ippon
3	Christopher RESTREPO, Kawasaki

U12 Male G2

Competitors/Compétiteurs

#	Name/Nom	Grade	Club	1	2	3	4	W/G	Pts	Pos
1	Vadim OGARKOV	Yellow	Ippon	XX		5	10	2	15	2
2	Ruslan TYNAROV	Orange	Ippon	10	XX	10	10	3	30	1
3	Andrii RYBALCHENKO	Orange	Ajax Budokan			XX	10	1	10	3
4	Britton WALBY	Orange	Takahashi				XX	0	0	4

Matches/Matches

Match	White/Blanc			Blue/Bleu	Res/Rés	Tim/Tmp	Code
D-6	Vadim OGARKOV	1	2	Ruslan TYNAROV	0 - 10	0:00	IPO
D-7	Andrii RYBALCHENKO	3	4	Britton WALBY	10 - 0	0:14	IPO
D-12	Vadim OGARKOV	1	3	Andrii RYBALCHENKO	5 - 0	2:00	WAZ
D-13	Ruslan TYNAROV	2	4	Britton WALBY	10 - 0	0:05	IPO
D-20	Vadim OGARKOV	1	4	Britton WALBY	10 - 0	2:00	WIP
D-21	Ruslan TYNAROV	2	3	Andrii RYBALCHENKO	10 - 0	1:00	IPO

Results/Résultats

Pos	Name/Nom
1	Ruslan TYNAROV, Ippon
2	Vadim OGARKOV, Ippon
3	Andrii RYBALCHENKO, Ajax Budokan

U12 Male G3

Competitors/Compétiteurs

#	Name/Nom	Grade	Club	1	2	3	W/G	Pts	Pos
1	Gabrieli KVARATSKHELIA	Yellow	Olympic	XX	10		1	10	2
2	Benjamin O'BOMSAWIN	Orange	Ninja		XX		0	0	3
3	Bentley HOLMES	Orange	Huntsville	1	10	XX	2	11	1

Matches/Matches

Match	White/Blanc			Blue/Bleu	Res/Rés	Tim/Tmp	Code
B-5	Gabrieli KVARATSKHELIA	1	2	Benjamin O'BOMSAWIN	10 - 0	1:24	IPO
B-11	Gabrieli KVARATSKHELIA	1	3	Bentley HOLMES	0 - 1	4:00	YUS
B-15	Benjamin O'BOMSAWIN	2	3	Bentley HOLMES	0 - 10	0:07	IPO

Results/Résultats

Pos	Name/Nom
1	Bentley HOLMES, Huntsville
2	Gabrieli KVARATSKHELIA, Olympic

U12 Male G4

Competitors/Compétiteurs

#	Name/Nom	Grade	Club	1	2	3	4	W/G	Pts	Pos
1	Matthew SIBIRYAKOV	Green	Sheffield	XX	10	10	10	3	30	1
2	Vladyslav KHADZHYNNOV	Orange	Ajax Budokan		XX		1	1	1	3
3	Thomas GILL	Orange	Shidokan		10	XX	10	2	20	2
4	Ethan FU	Orange	Shin Bu Kan (ON)				XX	0	0	4

Matches/Matches

Match	White/Blanc			Blue/Bleu	Res/Rés	Tim/Tmp	Code
B-6	Matthew SIBIRYAKOV	1	2	Vladyslav KHADZHYNNOV	10 - 0	0:15	IPO
B-12	Thomas GILL	3	4	Ethan FU	10 - 0	0:26	IPO
B-16	Matthew SIBIRYAKOV	1	3	Thomas GILL	10 - 0	1:05	IPO
B-17	Vladyslav KHADZHYNNOV	2	4	Ethan FU	1 - 0	4:00	YUS
B-21	Matthew SIBIRYAKOV	1	4	Ethan FU	10 - 0	0:48	IPO
B-22	Vladyslav KHADZHYNNOV	2	3	Thomas GILL	0 - 10	0:38	IPO

Results/Résultats

Pos	Name/Nom
1	Matthew SIBIRYAKOV, Sheffield
2	Thomas GILL, Shidokan
3	Vladyslav KHADZHYNNOV, Ajax Budokan

U12 Male G5

Competitors/Compétiteurs

#	Name/Nom	Grade	Club	1	2	3	4	W/G	Pts	Pos
1	Rayan JAFRI	Yellow	Challenge	XX				0	0	4
2	Leo CHECHKIN	Orange	Challenge	10	XX		10	2	20	2
3	Severin URRUELA	Yellow	Shidokan	10	10	XX	10	3	30	1
4	Orian TELEKI	Orange	Ninja	10			XX	1	10	3

Matches/Matches

Match	White/Blanc			Blue/Bleu	Res/Rés	Tim/Tmp	Code
A-2	Rayan JAFRI	1	2	Leo CHECHKIN	0 - 10	0:19	WIP
A-5	Severin URRUELA	3	4	Orian TELEKI	10 - 0	0:17	IPO
A-10	Rayan JAFRI	1	3	Severin URRUELA	0 - 10	1:00	IPO
A-16	Leo CHECHKIN	2	4	Orian TELEKI	10 - 0	0:42	IPO
A-22	Rayan JAFRI	1	4	Orian TELEKI	0 - 10	0:04	IPO
A-27	Leo CHECHKIN	2	3	Severin URRUELA	0 - 10	1:38	WIP

Results/Résultats

Pos	Name/Nom
1	Severin URRUELA, Shidokan
2	Leo CHECHKIN, Challenge
3	Orian TELEKI, Ninja

U12 Male G6

Competitors/Compétiteurs

#	Name/Nom	Grade	Club	1	2	3	W/G	Pts	Pos
1	Ivan KRAEV	Yellow	Challenge	XX		10	1	10	2
2	Davit TSIKLARI	Yellow	Olympic	10	XX	10	2	20	1
3	Anthony CHEN	Yellow	Hayabusakan			XX	0	0	3

Matches/Matches

Match	White/Blanc			Blue/Bleu	Res/Rés	Tim/Tmp	Code
D-8	Ivan KRAEV	1	2	Davit TSIKLARI	0 - 10	0:54	WIP
D-14	Ivan KRAEV	1	3	Anthony CHEN	10 - 0	0:05	IPO
D-22	Davit TSIKLARI	2	3	Anthony CHEN	10 - 0	0:41	WIP

Results/Résultats

Pos	Name/Nom
1	Davit TSIKLARI, Olympic
2	Ivan KRAEV, Challenge

U12 Male G7

Competitors/Compétiteurs

#	Name/Nom	Grade	Club	1	2	3	4	W/G	Pts	Pos
1	Elliott POLTORAC	Orange	Challenge	XX			10	1	10	3
2	Adnan MAMMADLI	Orange	Challenge	10	XX		10	2	20	2
3	Max BRISSON	Orange	Shidokan	10	10	XX		2	20	1
4	Lucas SCORTEANU	Yellow	Shidokan			5	XX	1	5	4

Matches/Matches

Match	White/Blanc			Blue/Bleu	Res/Rés	Tim/Tmp	Code
A-6	Elliott POLTORAC	1	2	Adnan MAMMADLI	0 - 10	1:23	IPO
A-13	Max BRISSON	3	4	Lucas SCORTEANU	0 - 5	2:00	WAZ
A-19	Elliott POLTORAC	1	3	Max BRISSON	0 - 10	0:10	IPO
A-20	Adnan MAMMADLI	2	4	Lucas SCORTEANU	10 - 0	2:00	IPO
A-24	Elliott POLTORAC	1	4	Lucas SCORTEANU	10 - 0	0:57	IPO
A-25	Adnan MAMMADLI	2	3	Max BRISSON	0 - 10	0:13	IPO

Results/Résultats

Pos	Name/Nom
1	Max BRISSON, Shidokan
2	Adnan MAMMADLI, Challenge
3	Elliott POLTORAC, Challenge
4	Lucas SCORTEANU, Shidokan

U12 Male G8

Competitors/Compétiteurs

#	Name/Nom	Grade	Club	1	2	3	W/G	Pts	Pos
1	Gabriel MEARAKISHVILI	Yellow	Olympic	XX		5	1	5	2
2	Gabrieli KHINGAVA	Yellow	Olympic	10	XX	10	2	20	1
3	Sam HASSANPOUR	Orange	Challenge			XX	0	0	3

Matches/Matches

Match	White/Blanc			Blue/Bleu	Res/Rés	Tim/Tmp	Code
B-13	Gabriel MEARAKISHVILI	1	2	Gabrieli KHINGAVA	0 - 10	1:58	IPO
B-18	Gabriel MEARAKISHVILI	1	3	Sam HASSANPOUR	5 - 0	2:00	WAZ
B-23	Gabrieli KHINGAVA	2	3	Sam HASSANPOUR	10 - 0	0:00	IPO

Results/Résultats

Pos	Name/Nom
1	Gabrieli KHINGAVA, Olympic
2	Gabriel MEARAKISHVILI, Olympic

U12 Female G1

Competitors/Compétiteurs

#	Name/Nom	Grade	Club	1	2	1	2	1	2	W/G	Pts	Pos
1	Cammy LEE	Yellow	Sheffield	XX	10	XX		XX	10	2	20	1
2	Madisyn YEUNG	Yellow	Sheffield		XX	10	XX		XX	1	10	2

Matches/Matches

Match	White/Blanc			Blue/Bleu	Res/Rés	Tim/Tmp	Code
A-15	Cammy LEE	1	2	Madisyn YEUNG	10 - 0	0:13	IPO
A-21	Madisyn YEUNG	2	1	Cammy LEE	10 - 0	0:12	IPO
A-26	Cammy LEE	1	2	Madisyn YEUNG	10 - 0	0:28	WIP

Results/Résultats

Pos	Name/Nom
1	Cammy LEE, Sheffield
2	Madisyn YEUNG, Sheffield

U12 Female G2

Competitors/Compétiteurs

#	Name/Nom	Grade	Club	1	2	3	4	W/G	Pts	Pos
1	Eva REGO	Yellow	Numa	XX		10	10	2	20	1
2	Sara ARIFOVA	Yellow	Numa	10	XX	10		2	20	2
3	Peyton CYTOWICZ	Yellow	Ninja			XX		0	0	4
4	Claire BOSQUET	Orange	Challenge		10	10	XX	2	20	3

Matches/Matches

Match	White/Blanc			Blue/Bleu	Res/Rés	Tim/Tmp	Code
E-3	Eva REGO	1	2	Sara ARIFOVA	0 - 10	0:31	IPO
E-4	Peyton CYTOWICZ	3	4	Claire BOSQUET	0 - 10	0:33	IPO
E-9	Eva REGO	1	3	Peyton CYTOWICZ	10 - 0	0:49	IPO
E-10	Sara ARIFOVA	2	4	Claire BOSQUET	0 - 10	1:27	WIP
E-20	Eva REGO	1	4	Claire BOSQUET	10 - 0	0:13	IPO
E-23	Sara ARIFOVA	2	3	Peyton CYTOWICZ	10 - 0	0:29	IPO

Results/Résultats

Pos	Name/Nom
1	Eva REGO, Numa
1	Sara ARIFOVA, Numa
1	Claire BOSQUET, Challenge

U12 Female G3

Competitors/Compétiteurs

#	Name/Nom	Grade	Club	1	2	3	W/G	Pts	Pos
1	Giuliana SKALJAC	Yellow	Kawasaki	XX	10		1	10	2
2	Alina AVTONOMOV	Green	Kawasaki		XX		0	0	3
3	Georgina ROBINSON	Yellow	Full Circle	10	10	XX	2	20	1

Matches/Matches

Match	White/Blanc			Blue/Bleu	Res/Rés	Tim/Tmp	Code
E-13	Giuliana SKALJAC	1	2	Alina AVTONOMOV	10 - 0	0:24	IPO
E-21	Giuliana SKALJAC	1	3	Georgina ROBINSON	0 - 10	0:49	IPO
E-24	Alina AVTONOMOV	2	3	Georgina ROBINSON	0 - 10	0:12	IPO

Results/Résultats

Pos	Name/Nom
1	Georgina ROBINSON, Full Circle
2	Giuliana SKALJAC, Kawasaki

U12 Female G4

Competitors/Compétiteurs

#	Name/Nom	Grade	Club	1	2	3	4	W/G	Pts	Pos
1	Ophélie ROY	Yellow	Seïkidokan (QC)	XX			10	1	10	3
2	Cloé GILL	Orange	Shidokan	10	XX	10	10	3	30	1
3	Ruby ROBINSON	Yellow	Full Circle	10		XX	10	2	20	2
4	Violet FOSTER	Yellow	Ninja				XX	0	0	4

Matches/Matches

Match	White/Blanc			Blue/Bleu	Res/Rés	Tim/Tmp	Code
C-4	Ophélie ROY	1	2	Cloé GILL	0 - 10	0:11	IPO
C-7	Ruby ROBINSON	3	4	Violet FOSTER	10 - 0	0:53	WIP
C-11	Ophélie ROY	1	3	Ruby ROBINSON	0 - 10	0:51	WIP
C-14	Cloé GILL	2	4	Violet FOSTER	10 - 0	0:09	IPO
C-18	Ophélie ROY	1	4	Violet FOSTER	10 - 0	0:26	WIP
C-21	Cloé GILL	2	3	Ruby ROBINSON	10 - 0	0:11	IPO

Results/Résultats

Pos	Name/Nom
1	Cloé GILL, Shidokan
2	Ruby ROBINSON, Full Circle
3	Ophélie ROY, Seïkidokan (QC)

U12 Female G5

Competitors/Compétiteurs

#	Name/Nom	Grade	Club	1	2	1	2	1	2	W/G	Pts	Pos
1	Suad ALIYEVA	Orange	Olympic	XX	10	XX		XX		1	10	2
2	Elodie BOZEC	Orange	Ajax Budokan		XX	5	XX	10	XX	2	15	1

Matches/Matches

Match	White/Blanc			Blue/Bleu	Res/Rés	Tim/Tmp	Code
C-3	Suad ALIYEVA	1	2	Elodie BOZEC	10 - 0	0:14	WIP
C-8	Elodie BOZEC	2	1	Suad ALIYEVA	5 - 0	2:00	WAZ
C-12	Suad ALIYEVA	1	2	Elodie BOZEC	0 - 10	0:55	IPO

Results/Résultats

Pos	Name/Nom
1	Elodie BOZEC, Ajax Budokan
2	Suad ALIYEVA, Olympic

Seniors Ne Waza M -66kg

Competitors/Compétiteurs

#	Name/Nom	Grade	Club	1	2	3	4	5	W/G	Pts	Pos
1	George FARNSWORTH	Brown	Takahashi	XX					0	0	5
2	Aj LONTAYAO	Brown	Campbell River	20	XX		16		2	36	3
3	Billy-Joe BALDONADO	Blue	Ishi Yama	20	4	XX	20		3	44	2
4	Abhiraj SARIN	Brown	RMC Judo Club	20			XX		1	20	4
5	Daniel MCCRISTALL	Nidan	Upper Canada	20	20	2	20	XX	4	62	1

Matches/Matches

Match	White/Blanc			Blue/Bleu	Res/Rés	Tim/Tmp	Code
C-1	Abhiraj SARIN	4	5	Daniel MCCRISTALL	0 - 20	2:10	xxx
C-5	George FARNSWORTH	1	2	Aj LONTAYAO	0 - 20	3:06	xxx
C-9	Billy-Joe BALDONADO	3	4	Abhiraj SARIN	20 - 2	1:03	xxx
C-13	George FARNSWORTH	1	5	Daniel MCCRISTALL	0 - 20	0:00	xxx
C-16	Aj LONTAYAO	2	3	Billy-Joe BALDONADO	2 - 4	4:00	xxx
C-19	George FARNSWORTH	1	4	Abhiraj SARIN	0 - 20	0:00	xxx
C-22	Billy-Joe BALDONADO	3	5	Daniel MCCRISTALL	0 - 2	4:00	xxx
C-23	Aj LONTAYAO	2	4	Abhiraj SARIN	16 - 4	4:00	xxx
C-24	George FARNSWORTH	1	3	Billy-Joe BALDONADO	0 - 20	0:00	xxx
C-25	Aj LONTAYAO	2	5	Daniel MCCRISTALL	0 - 20	2:43	xxx

Results/Résultats

Pos	Name/Nom
1	Daniel MCCRISTALL, Upper Canada
2	Billy-Joe BALDONADO, Ishi Yama
3	Aj LONTAYAO, Campbell River
4	Abhiraj SARIN, RMC Judo Club

Seniors Ne Waza M -81kg

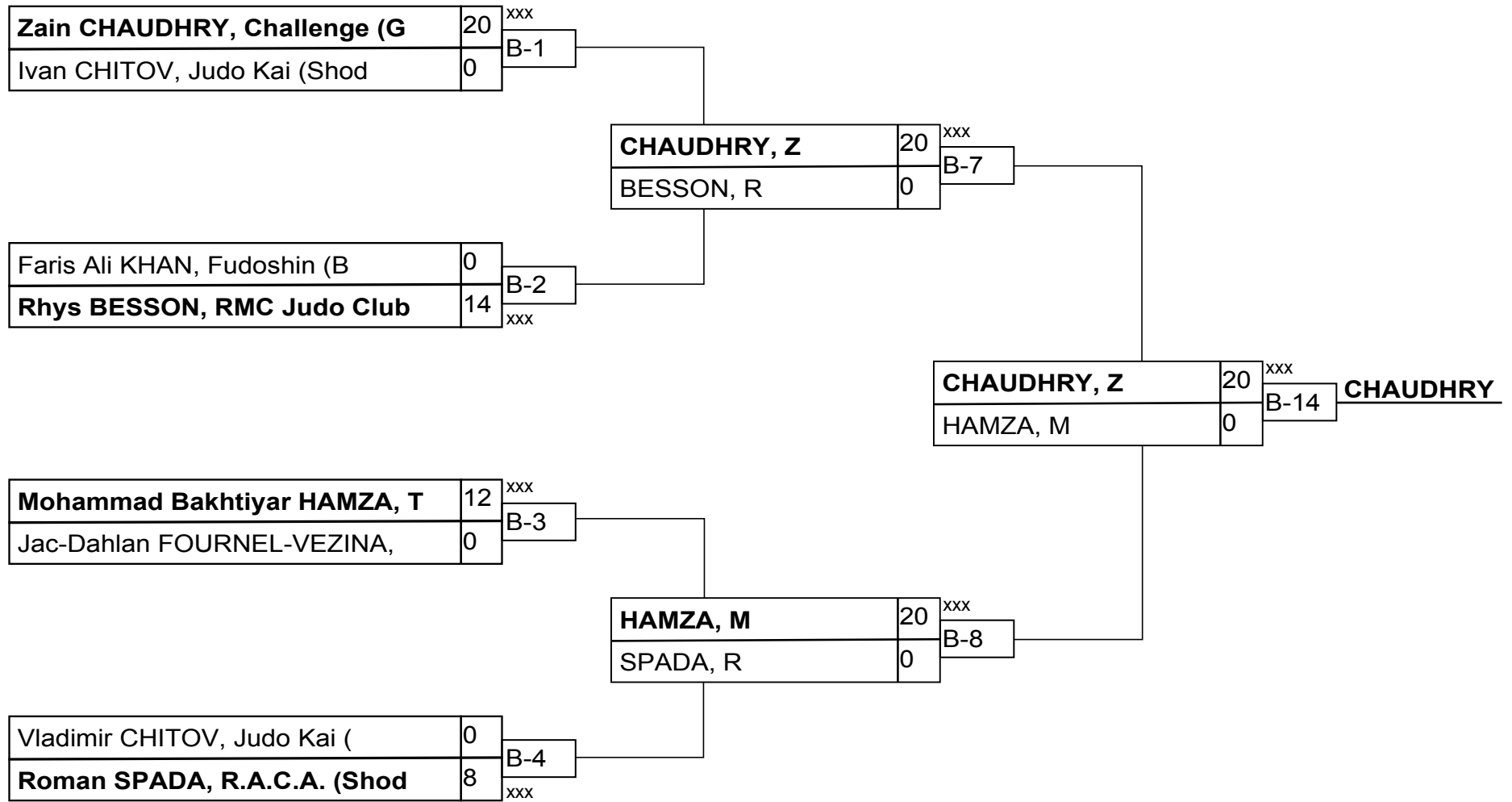

Results/Résultats

Pos	Name/Nom
1	Zain CHAUDHRY, Challenge
2	Mohammad Bakhtiyar HAMZA
3	Vladimir CHITOV, Judo Ka
3	Roman SPADA, R.A.C.A. (S

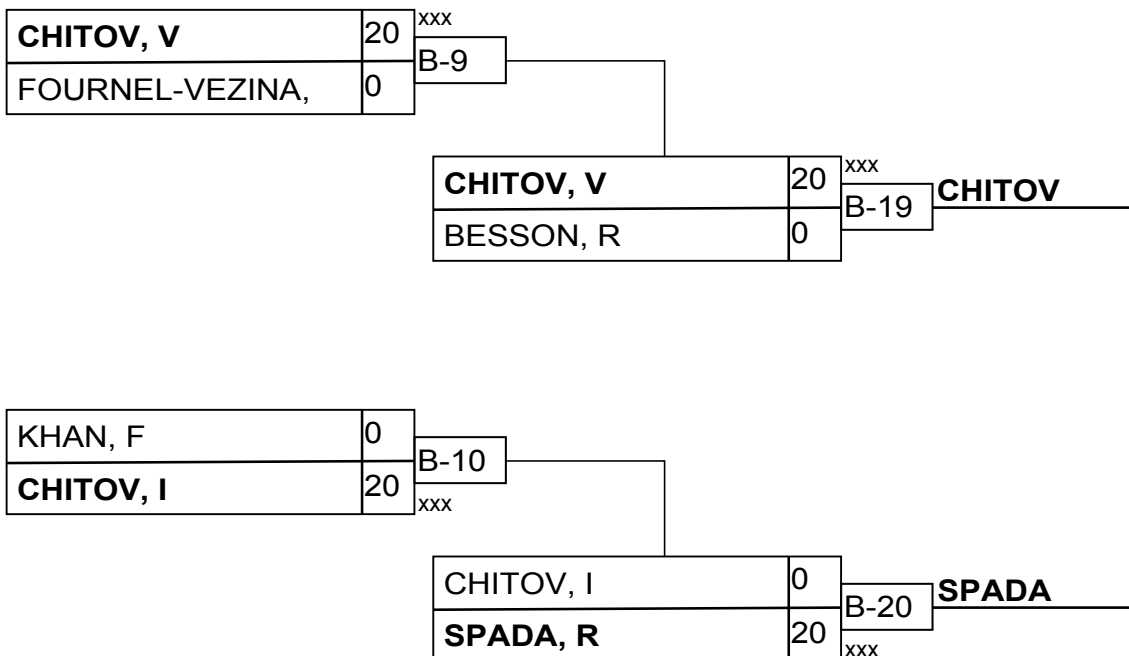

Seniors Ne Waza M -100kg

Competitors/Compétiteurs A

#	Name/Nom	Grade	Club	1	2	3	4	W/G	Pts	Pos
1	Satvik SOOD	Green	RMC Judo Club	XX				0	0	4
2	Richard TURNER	Brown	Ishi Yama	20	XX	20	20	3	60	1
3	Terry ST LOUIS	Brown	Huntsville	20		XX		1	20	3
4	Alec BRILLON	Shodan	Ottawa	20		10	XX	2	30	2

Pool A

Match	White/Blanc	Blue/Bleu	Res/Rés	Tim/Tmp	Code
A-1	Satvik SOOD 1 2	Richard TURNER	0 - 20	1:00	xxx
A-3	Terry ST LOUIS 3 4	Alec BRILLON	0 - 10	4:00	xxx
A-7	Satvik SOOD 1 3	Terry ST LOUIS	0 - 20	1:20	xxx
A-8	Richard TURNER 2 4	Alec BRILLON	20 - 0	1:31	xxx
A-11	Satvik SOOD 1 4	Alec BRILLON	0 - 20	0:45	xxx
A-12	Richard TURNER 2 3	Terry ST LOUIS	20 - 0	0:30	xxx

Competitors/Compétiteurs B

#	Name/Nom	Grade	Club	5	6	7	W/G	Pts	Pos
5	Josh JONES	Green	Huntsville	XX	10		1	10	3
6	Luca DE CICCIO	Green	RMC Judo Club		XX	20	1	20	1
7	Ian VAN STYGEREN	Green	Huntsville	20		XX	1	20	2

Pool B

Match	White/Blanc	Blue/Bleu	Res/Rés	Tim/Tmp	Code
A-4	Josh JONES 5 6	Luca DE CICCIO	10 - 0	4:00	xxx
A-9	Josh JONES 5 7	Ian VAN STYGEREN	0 - 20	2:11	xxx
A-14	Luca DE CICCIO 6 7	Ian VAN STYGEREN	20 - 0	3:37	xxx

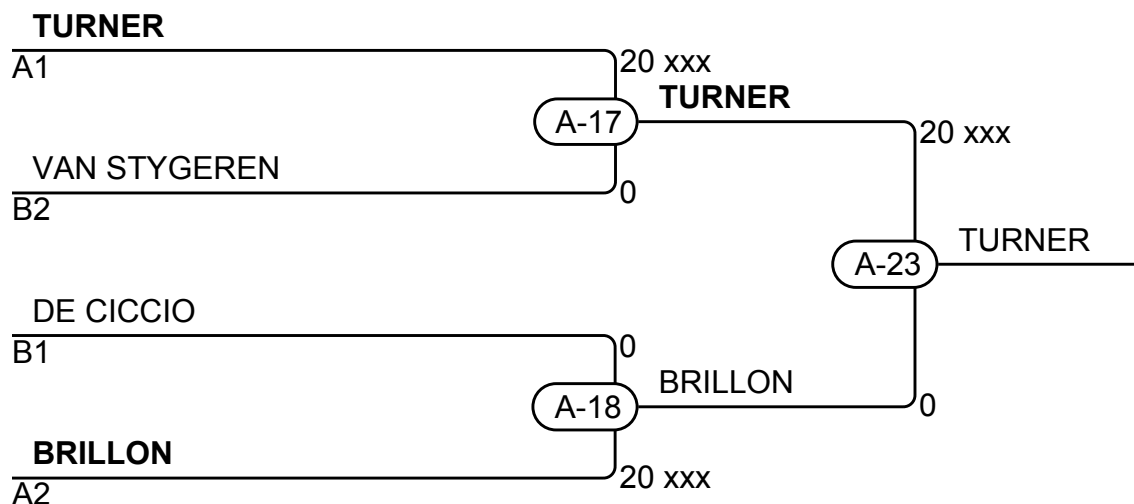

Results/Résultats

Pos	Name/Nom
1	Richard TURNER, Ishi Yama
2	Alec BRILLON, Ottawa
3	Ian VAN STYGEREN, Huntsville
3	Luca DE CICCIO, RMC Judo Club

Seniors Ne Waza M +100kg

Competitors/Compétiteurs

#	Name/Nom	Grade	Club	1	2	3	W/G	Pts	Pos
1	Jeff ALLEN	Shodan	Huntsville	XX	20	20	2	40	1
2	Jordan JONES	Green	Huntsville		XX		0	0	3
3	Robbinlee ITURRALDE	Green	IPÊ DOJO		20	XX	1	20	2

Matches/Matches

Match	White/Blanc			Blue/Bleu	Res/Rés	Tim/Tmp	Code
D-3	Jeff ALLEN	1	2	Jordan JONES	20 - 0	0:48	xxx
D-11	Jeff ALLEN	1	3	Robbinlee ITURRALDE	20 - 0	2:02	xxx
D-17	Jordan JONES	2	3	Robbinlee ITURRALDE	2 - 20	0:57	xxx

Results/Résultats

Pos	Name/Nom
1	Jeff ALLEN, Huntsville
2	Robbinlee ITURRALDE, IPÊ DOJO

Seniors Ne Waza F -70kg

Competitors/Compétiteurs A

#	Name/Nom	Grade	Club	1	2	3	W/G	Pts	Pos
1	Savannah MACDONALD	Brown	Huntsville	XX	20	20	2	40	1
2	Sofia TEPER	Brown	Hayabusakan		XX	20	1	20	2
3	Charelle KAMY	Blue	RMC Judo Club			XX	0	0	3

Pool A

Match	White/Blanc	Blue/Bleu	Res/Rés	Tim/Tmp	Code
E-1	Savannah MACDONALD	1 2 Sofia TEPER	20 - 0	1:22	xxx
E-7	Savannah MACDONALD	1 3 Charelle KAMY	20 - 0	0:19	xxx
E-14	Sofia TEPER	2 3 Charelle KAMY	20 - 0	0:00	xxx

Competitors/Compétiteurs B

#	Name/Nom	Grade	Club	4	5	6	W/G	Pts	Pos
4	Albina ROBINSON	Green	Huntsville	XX			0	0	3
5	Azra BENIC	Green	Saskatoon Y	20	XX		1	20	2
6	Annaliese HEISLER	Blue	IPÊ DOJO	20	20	XX	2	40	1

Pool B

Match	White/Blanc	Blue/Bleu	Res/Rés	Tim/Tmp	Code
E-2	Albina ROBINSON	4 5 Azra BENIC	0 - 20	1:51	xxx
E-8	Albina ROBINSON	4 6 Annaliese HEISLER	0 - 20	0:31	xxx
E-15	Azra BENIC	5 6 Annaliese HEISLER	0 - 20	2:48	xxx

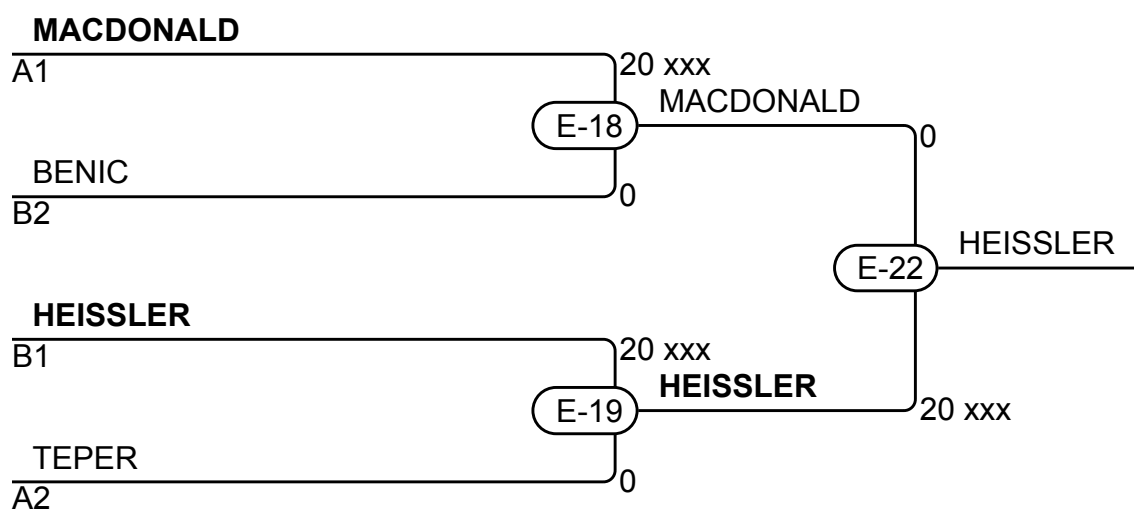

Results/Résultats

Pos	Name/Nom
1	Annaliese HEISLER, IPÊ DOJO
2	Savannah MACDONALD, Huntsville
3	Azra BENIC, Saskatoon Y
3	Sofia TEPER, Hayabusakan

Seniors Female Exhibition

Competitors/Compétiteurs

#	Name/Nom	Grade	Club	1	2	3	4	5	W/G	Pts	Pos
1	Joesphine FRASE	?		XX		10			1	10	
2	Alythea KARSERAS	?			XX	10			1	10	
3	Fatima KALAIR	?				XX					
4	Lilea MCKAY	?				10	XX		1	10	
5	Savanah MCDONALD	?				10		XX	1	10	

Matches/Matches

Match	White/Blanc	Blue/Bleu	Res/Rés	Tim/Tmp	Code
1	Lilea MCKAY	4 5 Savannah MCDONALD			
2	Joesphine FRASE	1 2 Alythea KARSERAS			
D-12A	Fatima KALAIR	3 4 Lilea MCKAY	0 - 10	0:30	IPO
4	Joesphine FRASE	1 5 Savannah MCDONALD			
D-20A	Alythea KARSERAS	2 3 Fatima KALAIR	10 - 0	0:09	IPO
6	Joesphine FRASE	1 4 Lilea MCKAY			
D-30A	Fatima KALAIR	3 5 Savanah MCDONALD	0 - 10	0:57	WIP
8	Alythea KARSERAS	2 4 Lilea MCKAY			
D-35	Joesphine FRASE	1 3 Fatima KALAIR	10 - 0	0:10	IPO
10	Alythea KARSERAS	2 5 Savannah MCDONALD			

Results/Résultats

Pos	Name/Nom

U14 Female -40kg

Competitors/Compétiteurs

#	Name/Nom	Grade	Club	1	2	3	4	W/G	Pts	Pos
1	Marianna SCHESNUIK	Blue	Judo Kai	XX	10	10	10	3	30	1
2	Eva WALBY	Green	Takahashi		XX			0	0	4
3	Taylor TRITTON	Green	Tritton Judo		10	XX	10	2	20	2
4	Brooklyn SEEMAN	Green	Lethbridge		10		XX	1	10	3

Matches/Matches

Match	White/Blanc			Blue/Bleu	Res/Rés	Tim/Tmp	Code
C-10	Marianna SCHESNUIK	1	2	Eva WALBY	10 - 0	0:06	IPO
C-13	Taylor TRITTON	3	4	Brooklyn SEEMAN	10 - 0	1:55	IPO
C-19	Marianna SCHESNUIK	1	3	Taylor TRITTON	10 - 0	2:14	IPO
C-20	Eva WALBY	2	4	Brooklyn SEEMAN	0 - 10	0:08	IPO
C-27	Marianna SCHESNUIK	1	4	Brooklyn SEEMAN	10 - 0	1:47	WIP
C-28	Eva WALBY	2	3	Taylor TRITTON	0 - 10	0:27	WIP

Results/Résultats

Pos	Name/Nom
1	Marianna SCHESNUIK, Judo Kai
2	Taylor TRITTON, Tritton Judo
3	Brooklyn SEEMAN, Lethbridge

U14 Female -48kg

Competitors/Compétiteurs

#	Name/Nom	Grade	Club	1	2	3	W/G	Pts	Pos
1	Victoria MUNOZ	Green	Blainville	XX			0	0	3
2	Rose PÉRUSSE	Green	Sakura (QC)	10	XX		1	10	2
3	Ksenia OUDOVIKINE	Green	Taifu	10	10	XX	2	20	1

Matches/Matches

Match	White/Blanc			Blue/Bleu	Res/Rés	Tim/Tmp	Code
E-17	Victoria MUNOZ	1	2	Rose PÉRUSSE	0 - 10	0:00	IPO
E-26	Victoria MUNOZ	1	3	Ksenia OUDOVIKINE	0 - 10	0:31	WIP
E-35	Rose PÉRUSSE	2	3	Ksenia OUDOVIKINE	0 - 10	0:36	IPO

Results/Résultats

Pos	Name/Nom
1	Ksenia OUDOVIKINE, Taifu
2	Rose PÉRUSSE, Sakura (QC)

U14 Female -52kg

Competitors/Compétiteurs

#	Name/Nom	Grade	Club	1	2	1	2	1	2	W/G	Pts	Pos
1	Claire OICKLE	Green	Numa	XX	10	XX	10	XX		2	20	1
2	Maleyha KARSERAS	Green	Takahashi		XX		XX		XX	0	0	2

Matches/Matches

Match	White/Blanc			Blue/Bleu	Res/Rés	Tim/Tmp	Code
B-12	Claire OICKLE	1	2	Maleyha KARSERAS	10 - 0	0:06	IPO
B-23	Maleyha KARSERAS	2	1	Claire OICKLE	0 - 10	0:39	IPO
B-30	Claire OICKLE	1	2	Maleyha KARSERAS			

Results/Résultats

Pos	Name/Nom
1	Claire OICKLE, Numa

U14 Male +66kg

Competitors/Compétiteurs

#	Name/Nom	Grade	Club	1	2	1	2	1	2	W/G	Pts	Pos
1	Umar ARIFOV	Green	Numa	XX	10	XX	10	XX		2	20	1
2	Fodé Amara N'DIAYE	Orange	Ottawa		XX		XX		XX	0	0	2

Matches/Matches

Match	White/Blanc			Blue/Bleu	Res/Rés	Tim/Tmp	Code
A-11	Umar ARIFOV	1	2	Fodé Amara N'DIAYE	10 - 0	0:20	IPO
A-21	Fodé Amara N'DIAYE	2	1	Umar ARIFOV	0 - 10	0:12	IPO
A-29	Umar ARIFOV	1	2	Fodé Amara N'DIAYE			

Results/Résultats

Pos	Name/Nom
1	Umar ARIFOV, Numa

U14 Male -60kg

Competitors/Compétiteurs

#	Name/Nom	Grade	Club	1	2	3	W/G	Pts	Pos
1	Tatum MOXLEY	Orange	Upper Canada	XX	10		1	10	2
2	Lukas SKALJAC	Orange	Kawasaki		XX		0	0	3
3	Mathias GUISEN	Green	Shidokan	10	10	XX	2	20	1

Matches/Matches

Match	White/Blanc			Blue/Bleu	Res/Rés	Tim/Tmp	Code
E-16	Tatum MOXLEY	1	2	Lukas SKALJAC	10 - 0	0:34	IPO
E-25	Tatum MOXLEY	1	3	Mathias GUISEN	0 - 10	3:00	KIK
E-34	Lukas SKALJAC	2	3	Mathias GUISEN	0 - 10	0:00	IPO

Results/Résultats

Pos	Name/Nom
1	Mathias GUISEN, Shidokan
2	Tatum MOXLEY, Upper Canada

U14 Male -55kg

Competitors/Compétiteurs

#	Name/Nom	Grade	Club	1	2	3	W/G	Pts	Pos
1	Ashkan KHAHAN ZAMORA	Green	Tritton	XX		10	1	10	2
2	Ibrahim AZAR	Green	Shidokan	10	XX	10	2	20	1
3	Fernando TANAKA SVERZUT	Green	Police Jr.			XX	0	0	3

Matches/Matches

Match	White/Blanc			Blue/Bleu	Res/Rés	Tim/Tmp	Code
D-4	Ashkan KHAHAN ZAMORA	1	2	Ibrahim AZAR	0 - 10	2:50	WIP
D-15	Ashkan KHAHAN ZAMORA	1	3	Fernando TANAKA SVERZUT	10 - 0	0:54	IPO
D-26	Ibrahim AZAR	2	3	Fernando TANAKA SVERZUT	10 - 0	0:39	WIP

Results/Résultats

Pos	Name/Nom
1	Ibrahim AZAR, Shidokan
2	Ashkan KHAHAN ZAMORA, Tritton

U14 Male -46kg

Competitors/Compétiteurs

#	Name/Nom	Grade	Club	1	2	3	4	5	W/G	Pts	Pos
1	David ABRAMOVICH	Green	Olympic	XX	10	10	10		3	30	1
2	Alexi MIRON	Green	Seikidokan (QC)		XX	10	10	10	3	30	2
3	Emerick HEROUX	Green	Blainville			XX	10		1	10	4
4	Anthony Francois BOUERI	Green	Ajax Budokan				XX		0	0	5
5	Grayson BARCLAY	Green	Asahi	10		10	1	XX	3	21	3

Matches/Matches

Match	White/Blanc			Blue/Bleu	Res/Rés	Tim/Tmp	Code
E-1	Anthony Francois BOUERI	4	5	Grayson BARCLAY	0 - 1	6:00	YUS
E-2	David ABRAMOVICH	1	2	Alexi MIRON	10 - 0	2:01	WIP
E-6	Emerick HEROUX	3	4	Anthony Francois BOUERI	10 - 0	3:00	IPO
E-7	David ABRAMOVICH	1	5	Grayson BARCLAY	0 - 10	0:00	IPO
E-11	Alexi MIRON	2	3	Emerick HEROUX	10 - 0	1:06	WIP
E-12	David ABRAMOVICH	1	4	Anthony Francois BOUERI	10 - 0	1:26	HAN
E-18	Emerick HEROUX	3	5	Grayson BARCLAY	0 - 10	0:06	IPO
E-19	Alexi MIRON	2	4	Anthony Francois BOUERI	10 - 0	0:21	WIP
E-27	David ABRAMOVICH	1	3	Emerick HEROUX	10 - 0	0:16	IPO
E-28	Alexi MIRON	2	5	Grayson BARCLAY	10 - 0	3:00	IPO

Results/Résultats

Pos	Name/Nom
1	David ABRAMOVICH, Olympic
2	Alexi MIRON, Seikidokan (QC)
3	Grayson BARCLAY, Asahi
4	Emerick HEROUX, Blainville

U14 Male -42kg

Competitors/Compétiteurs

#	Name/Nom	Grade	Club	1	2	3	4	W/G	Pts	Pos
1	Giorgi KURASHVILI	Green	Olympic	XX	10		10	2	20	2
2	Alexey MEJERY	Green	Taifu		XX			0	0	4
3	Ewen LE BRIS	Blue	Peak Judo Club	10	10	XX	10	3	30	1
4	Cadel TALBOT	Blue	Baie-Comeau		10		XX	1	10	3

Matches/Matches

Match	White/Blanc			Blue/Bleu	Res/Rés	Tim/Tmp	Code
B-13	Giorgi KURASHVILI	1	2	Alexey MEJERY	10 - 0	0:14	IPO
B-16	Ewen LE BRIS	3	4	Cadel TALBOT	10 - 0	2:19	IPO
B-24	Giorgi KURASHVILI	1	3	Ewen LE BRIS	0 - 10	3:00	IPO
B-25	Alexey MEJERY	2	4	Cadel TALBOT	0 - 10	0:42	WIP
B-31	Giorgi KURASHVILI	1	4	Cadel TALBOT	10 - 0	2:11	IPO
B-32	Alexey MEJERY	2	3	Ewen LE BRIS	0 - 10	0:00	FUS

Results/Résultats

Pos	Name/Nom
1	Ewen LE BRIS, Peak Judo Club
2	Giorgi KURASHVILI, Olympic
3	Cadel TALBOT, Baie-Comeau

U14 Male -38kg

Competitors/Compétiteurs

#	Name/Nom	Grade	Club	1	2	3	4	5	W/G	Pts	Pos
1	Simeon BALANDIN	Green	Formokan	XX					0	0	5
2	Peter DEMENEV	Green	Olympic	10	XX	10	10	10	4	40	1
3	Cooper DOBSON	Green	Hiro's	5		XX			1	5	4
4	Prokhor RESHETNIKOV	Green	Taifu	10		10	XX	5	3	25	2
5	Lucas SINENKO	Green	Taifu	10		10		XX	2	20	3

Matches/Matches

Match	White/Blanc			Blue/Bleu	Res/Rés	Tim/Tmp	Code
E-3	Prokhor RESHETNIKOV	4	5	Lucas SINENKO	5 - 0	3:00	WAZ
E-4	Simeon BALANDIN	1	2	Peter DEMENEV	0 - 10	1:04	IPO
E-8	Cooper DOBSON	3	4	Prokhor RESHETNIKOV	0 - 10	2:16	IPO
E-9	Simeon BALANDIN	1	5	Lucas SINENKO	0 - 10	0:58	HAN
E-13	Peter DEMENEV	2	3	Cooper DOBSON	10 - 0	1:06	IPO
E-14	Simeon BALANDIN	1	4	Prokhor RESHETNIKOV	0 - 10	0:55	WIP
E-20	Cooper DOBSON	3	5	Lucas SINENKO	0 - 10	0:00	IPO
E-21	Peter DEMENEV	2	4	Prokhor RESHETNIKOV	10 - 0	2:06	IPO
E-29	Simeon BALANDIN	1	3	Cooper DOBSON	0 - 5	3:00	WAZ
E-30	Peter DEMENEV	2	5	Lucas SINENKO	10 - 0	1:34	WIP

Results/Résultats

Pos	Name/Nom
1	Peter DEMENEV, Olympic
2	Prokhor RESHETNIKOV, Taifu
3	Lucas SINENKO, Taifu
4	Cooper DOBSON, Hiro's

U14 Male -35kg

Competitors/Compétiteurs

#	Name/Nom	Grade	Club	1	2	1	2	1	2	W/G	Pts	Pos
1	Tikhon PETROCHENKOV	Green	Taifu	XX	10	XX	10	XX		2	20	1
2	Victor TAJEDDINE	Green	Chu's Martial Art's Worl		XX		XX		XX	0	0	2

Matches/Matches

Match	White/Blanc			Blue/Bleu	Res/Rés	Tim/Tmp	Code
B-17	Tikhon PETROCHENKOV	1	2	Victor TAJEDDINE	10 - 0	3:00	IPO
B-26	Victor TAJEDDINE	2	1	Tikhon PETROCHENKOV	0 - 10	3:00	IPO
B-33	Tikhon PETROCHENKOV	1	2	Victor TAJEDDINE			

Results/Résultats

Pos	Name/Nom
1	Tikhon PETROCHENKOV, Taifu

U14 Novice Female -36kg

Competitors/Compétiteurs

#	Name/Nom	Grade	Club	1	2	1	2	1	2	W/G	Pts	Pos
1	Clare SCHECHNUIK	Orange	Judo Kai	XX	10	XX	10	XX		2	20	1
2	Violet SINGH	Orange	Spryfield		XX		XX		XX	0	0	2

Matches/Matches

Match	White/Blanc			Blue/Bleu	Res/Rés	Tim/Tmp	Code
A-20	Clare SCHECHNUIK	1	2	Violet SINGH	10 - 0	0:38	IPO
A-28	Violet SINGH	2	1	Clare SCHECHNUIK	0 - 10	0:27	WIP
A-34	Clare SCHECHNUIK	1	2	Violet SINGH			

Results/Résultats

Pos	Name/Nom
1	Clare SCHECHNUIK, Judo Kai

U14 Novice Female -48kg

Competitors/Compétiteurs

#	Name/Nom	Grade	Club	1	2	3	W/G	Pts	Pos
1	Alina PRISEKINA	Orange	Kawasaki	XX	10	10	2	20	1
2	Laykin MINIOTAS	Yellow	Judokaa		XX		0	0	3
3	Elleigh-Jane LOVELL	Orange	Asahi		10	XX	1	10	2

Matches/Matches

Match	White/Blanc			Blue/Bleu	Res/Rés	Tim/Tmp	Code
A-19	Alina PRISEKINA	1	2	Laykin MINIOTAS	10 - 0	0:04	IPO
A-27	Alina PRISEKINA	1	3	Elleigh-Jane LOVELL	10 - 0	1:25	WIP
A-33	Laykin MINIOTAS	2	3	Elleigh-Jane LOVELL	0 - 10	0:28	WIP

Results/Résultats

Pos	Name/Nom
1	Alina PRISEKINA, Kawasaki
2	Elleigh-Jane LOVELL, Asahi

U14 Novice Female -52kg

Competitors/Compétiteurs

#	Name/Nom	Grade	Club	1	2	1	2	1	2	W/G	Pts	Pos
1	Eva LUNA	Yellow	Hana no Bushidokai	XX	10	XX		XX		1	10	2
2	Alexandra PETINES	Yellow	Judokaa		XX	10	XX	10	XX	2	20	1

Matches/Matches

Match	White/Blanc			Blue/Bleu	Res/Rés	Tim/Tmp	Code
C-9	Eva LUNA	1	2	Alexandra PETINES	10 - 0	0:32	WIP
C-18	Alexandra PETINES	2	1	Eva LUNA	10 - 0	0:48	WIP
C-26	Eva LUNA	1	2	Alexandra PETINES	0 - 10	0:54	IPO

Results/Résultats

Pos	Name/Nom
1	Alexandra PETINES, Judokaa
2	Eva LUNA, Hana no Bushidokai

U14 Novice Female -57kg

Competitors/Compétiteurs

#	Name/Nom	Grade	Club	1	2	3	W/G	Pts	Pos
1	Julianna SNOW	Yellow	Crown Hill	XX			0	0	3
2	Mia DROLC	Yellow	Kohbukan-Sisu	10	XX		1	10	2
3	Samantha RICE	Orange	Upper Canada	10	10	XX	2	20	1

Matches/Matches

Match	White/Blanc			Blue/Bleu	Res/Rés	Tim/Tmp	Code
A-18	Julianna SNOW	1	2	Mia DROLC	0 - 10	0:00	FUS
A-26	Julianna SNOW	1	3	Samantha RICE	0 - 10	0:42	HAN
A-32	Mia DROLC	2	3	Samantha RICE	0 - 10	1:43	WIP

Results/Résultats

Pos	Name/Nom
1	Samantha RICE, Upper Canada
2	Mia DROLC, Kohbukan-Sisu

U14 Novice Male -35kg

Competitors/Compétiteurs

#	Name/Nom	Grade	Club	1	2	3	4	W/G	Pts	Pos
1	James COOK	Yellow	Judokaa	XX			10	1	10	3
2	Ron PEDINOVSKY	Orange	Ottawa	10	XX		10	2	20	2
3	Victor SCORTEANU	Orange	Shidokan	10	10	XX	10	3	30	1
4	Shawn FURMAN	Orange	Challenge				XX	0	0	4

Matches/Matches

Match	White/Blanc			Blue/Bleu	Res/Rés	Tim/Tmp	Code
E-10	James COOK	1	2	Ron PEDINOVSKY	0 - 10	0:25	IPO
E-15	Victor SCORTEANU	3	4	Shawn FURMAN	10 - 0	0:00	IPO
E-23	James COOK	1	3	Victor SCORTEANU	0 - 10	0:50	IPO
E-24	Ron PEDINOVSKY	2	4	Shawn FURMAN	10 - 0	0:08	IPO
E-32	James COOK	1	4	Shawn FURMAN	10 - 0	1:38	HAN
E-33	Ron PEDINOVSKY	2	3	Victor SCORTEANU	0 - 10	0:46	IPO

Results/Résultats

Pos	Name/Nom
1	Victor SCORTEANU, Shidokan
2	Ron PEDINOVSKY, Ottawa
3	James COOK, Judokaa

U14 Novice Male -42kg

Competitors/Compétiteurs A

#	Name/Nom	Grade	Club	1	2	3	W/G	Pts	Pos
1	Jack DAVENPORT	Orange	Ninja	XX			0	0	3
2	David CULCITCHI	Orange	Ippon	10	XX	10	2	20	1
3	Joseph VERE	Orange	North Bay	10		XX	1	10	2

Pool A

Match	White/Blanc	Blue/Bleu	Res/Rés	Tim/Tmp	Code
C-4	Jack DAVENPORT 1 2	David CULCITCHI	0 - 10	0:20	WIP
C-15	Jack DAVENPORT 1 3	Joseph VERE	0 - 10	0:56	IPO
C-23	David CULCITCHI 2 3	Joseph VERE	10 - 0	0:42	IPO

Competitors/Compétiteurs B

#	Name/Nom	Grade	Club	4	5	6	W/G	Pts	Pos
4	Daniyal KUMYKOV	Orange	Olympic	XX			0	0	3
5	Kaden DAYA	Orange	Shin Bu Kan (ON)	10	XX		1	10	2
6	Tymofii SHEIKO	Orange	Ippon	10	10	XX	2	20	1

Pool B

Match	White/Blanc	Blue/Bleu	Res/Rés	Tim/Tmp	Code
C-5	Daniyal KUMYKOV 4 5	Kaden DAYA	0 - 10	0:45	IPO
C-16	Daniyal KUMYKOV 4 6	Tymofii SHEIKO	0 - 10	3:00	IPO
C-24	Kaden DAYA 5 6	Tymofii SHEIKO	0 - 10	0:42	IPO

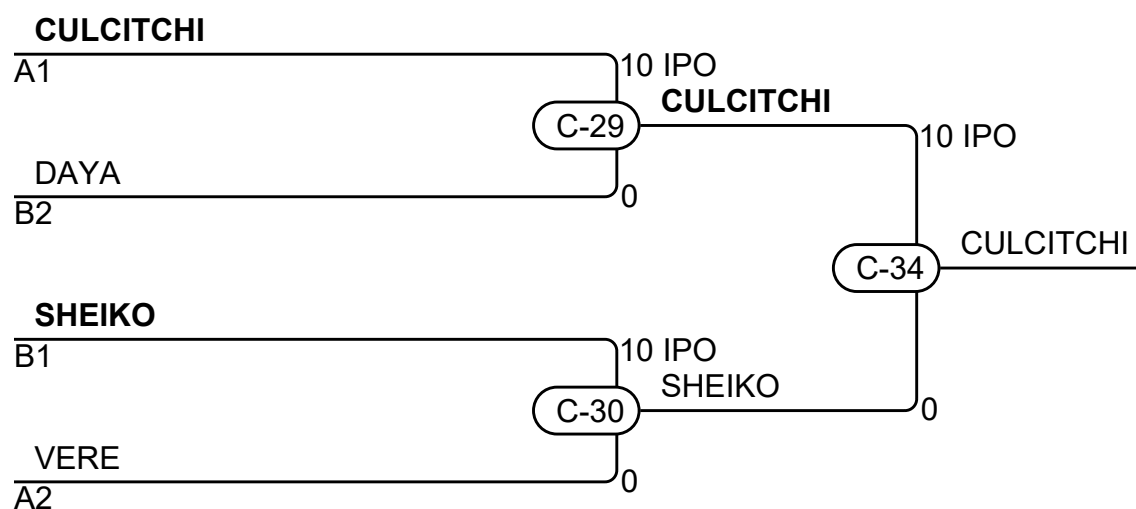

Results/Résultats

Pos	Name/Nom
1	David CULCITCHI, Ippon
2	Tymofii SHEIKO, Ippon
3	Kaden DAYA, Shin Bu Kan (ON)
3	Joseph VERE, North Bay

U14 Novice Male -46kg

Competitors/Compétiteurs

#	Name/Nom	Grade	Club	1	2	1	2	1	2	W/G	Pts	Pos
1	Axel MERTARCHYAN	Orange	Challenge	XX		XX		XX		0	0	2
2	Matthew FU	Orange	Shin Bu Kan (ON)	10	XX	10	XX		XX	2	20	1

Matches/Matches

Match	White/Blanc			Blue/Bleu	Res/Rés	Tim/Tmp	Code
D-10	Axel MERTARCHYAN	1	2	Matthew FU	0 - 10	0:08	IPO
D-21	Matthew FU	2	1	Axel MERTARCHYAN	10 - 0	0:36	IPO
D-32	Axel MERTARCHYAN	1	2	Matthew FU			

Results/Résultats

Pos	Name/Nom
1	Matthew FU, Shin Bu Kan (ON)

U14 Novice Male -50kg

Competitors/Compétiteurs

#	Name/Nom	Grade	Club	1	2	1	2	1	2	W/G	Pts	Pos
1	Raphael CASSISTA	Orange	Multisports	XX	10	XX	10	XX		2	20	1
2	Daniel NASSIF	Orange	Challenge		XX		XX		XX	0	0	2

Matches/Matches

Match	White/Blanc			Blue/Bleu	Res/Rés	Tim/Tmp	Code
B-9	Raphael CASSISTA	1	2	Daniel NASSIF	10 - 0	0:45	IPO
B-22	Daniel NASSIF	2	1	Raphael CASSISTA	0 - 10	1:04	IPO
B-29	Raphael CASSISTA	1	2	Daniel NASSIF			

Results/Résultats

Pos	Name/Nom
1	Raphael CASSISTA, Multisports

U14 Novice Male -66kg

Competitors/Compétiteurs

#	Name/Nom	Grade	Club	1	2	1	2	1	2	W/G	Pts	Pos
1	Luka BEKAURI	Orange	Olympic	XX		XX	10	XX	5	2	15	1
2	Nicholas (Cole) GOVAS	Yellow	Judo Kai	10	XX		XX		XX	1	10	2

Matches/Matches

Match	White/Blanc			Blue/Bleu	Res/Rés	Tim/Tmp	Code
E-5	Luka BEKAURI	1	2	Nicholas (Cole) GOVAS	0 - 10	2:00	HAN
E-22	Nicholas (Cole) GOVAS	2	1	Luka BEKAURI	0 - 10	0:00	IPO
E-31	Luka BEKAURI	1	2	Nicholas (Cole) GOVAS	5 - 0	3:00	WAZ

Results/Résultats

Pos	Name/Nom
1	Luka BEKAURI, Olympic
2	Nicholas (Cole) GOVAS, Judo Kai

Veterans Female +78kg

Competitors/Compétiteurs

#	Name/Nom	Grade	Club	1	2	1	2	1	2	W/G	Pts	Pos
1	Colleen FRASER	Brown	Huntsville	XX		XX		XX		0	0	2
2	Amanda MCALPINE	Shodan	Full Circle	10	XX	10	XX		XX	2	20	1

Matches/Matches

Match	White/Blanc			Blue/Bleu	Res/Rés	Tim/Tmp	Code
C-8	Colleen FRASER	1	2	Amanda MCALPINE	0 - 10	1:36	WIP
C-17	Amanda MCALPINE	2	1	Colleen FRASER	10 - 0	1:06	WIP
C-25	Colleen FRASER	1	2	Amanda MCALPINE			

Results/Résultats

Pos	Name/Nom
1	Amanda MCALPINE, Full Circle

Veterans Male -60kg

Competitors/Compétiteurs

#	Name/Nom	Grade	Club	1	2	1	2	1	2	W/G	Pts	Pos
1	Samuel MCLEAN	Blue	Fudoshin	XX		XX		XX		0	0	2
2	Shujon MAZUMDER	Yondan	Judo Kai	10	XX	10	XX		XX	2	20	1

Matches/Matches

Match	White/Blanc			Blue/Bleu	Res/Rés	Tim/Tmp	Code
D-13	Samuel MCLEAN	1	2	Shujon MAZUMDER	0 - 10	0:19	IPO
D-22	Shujon MAZUMDER	2	1	Samuel MCLEAN	10 - 0	0:03	IPO
D-33	Samuel MCLEAN	1	2	Shujon MAZUMDER			

Results/Résultats

Pos	Name/Nom
1	Shujon MAZUMDER, Judo Kai

Veterans Male -66kg

Competitors/Compétiteurs

#	Name/Nom	Grade	Club	1	2	3	4	5	W/G	Pts	Pos
1	Mikhail URITSKY	Sandan	Kodokwai	XX		10			1	10	4
2	Diego SANCHEZ	Shodan	Kawasaki	10	XX	10	10	5	4	35	1
3	Robert PHUONG	Brown	Scarborough			XX			0	0	5
4	Tim TAKAHASHI	Sandan	Lethbridge	10		10	XX	10	3	30	2
5	Billy-Joe BALDONADO	Blue	Ishi Yama	10		10		XX	2	20	3

Matches/Matches

Match	White/Blanc			Blue/Bleu	Res/Rés	Tim/Tmp	Code
D-1	Tim TAKAHASHI	4	5	Billy-Joe BALDONADO	10 - 0	2:10	IPO
D-2	Mikhail URITSKY	1	2	Diego SANCHEZ	0 - 10	0:21	IPO
D-6	Robert PHUONG	3	4	Tim TAKAHASHI	0 - 10	0:43	IPO
D-7	Mikhail URITSKY	1	5	Billy-Joe BALDONADO	0 - 10	0:28	IPO
D-11	Diego SANCHEZ	2	3	Robert PHUONG	10 - 0	0:42	IPO
D-12	Mikhail URITSKY	1	4	Tim TAKAHASHI	0 - 10	0:07	IPO
D-16	Robert PHUONG	3	5	Billy-Joe BALDONADO	0 - 10	1:01	IPO
D-17	Diego SANCHEZ	2	4	Tim TAKAHASHI	10 - 0	1:03	IPO
D-27	Mikhail URITSKY	1	3	Robert PHUONG	10 - 0	1:10	IPO
D-28	Diego SANCHEZ	2	5	Billy-Joe BALDONADO	5 - 0	0:00	WAZ

Results/Résultats

Pos	Name/Nom
1	Diego SANCHEZ, Kawasaki
2	Tim TAKAHASHI, Lethbridge
3	Billy-Joe BALDONADO, Ishi Yama
4	Mikhail URITSKY, Kodokwai

Veterans Male -73kg

Competitors/Compétiteurs A

#	Name/Nom	Grade	Club	1	2	3	4	W/G	Pts	Pos
1	Marcus SCHULTZE	Shodan	Tora	XX				0	0	4
2	Brian MCHALE	Shodan	Takahashi	10	XX	10	10	3	30	1
3	Kyle WEBER	Brown	Fudoshin	10		XX	10	2	20	2
4	Paul TELEKI	Nidan	Ninja	10			XX	1	10	3

Pool A

Match	White/Blanc			Blue/Bleu	Res/Rés	Tim/Tmp	Code
D-5	Marcus SCHULTZE	1	2	Brian MCHALE	0 - 10	1:58	WIP
D-8	Kyle WEBER	3	4	Paul TELEKI	10 - 0	0:18	IPO
D-18	Marcus SCHULTZE	1	3	Kyle WEBER	0 - 10	0:11	IPO
D-19	Brian MCHALE	2	4	Paul TELEKI	10 - 0	1:24	IPO
D-26A	Marcus SCHULTZE	1	4	Paul TELEKI	0 - 10	0:18	IPO
D-23	Brian MCHALE	2	3	Kyle WEBER	10 - 0	0:17	IPO

Competitors/Compétiteurs B

#	Name/Nom	Grade	Club	5	6	7	W/G	Pts	Pos
5	Pavel PAVLOV	Blue	Shin Bu Kan (ON)	XX			0	0	3
6	Andrew BROOKES	Shodan	Quinte	10	XX		1	10	2
7	Artur TARGOSINSKI	Nidan	Full Circle	10	10	XX	2	20	1

Pool B

Match	White/Blanc			Blue/Bleu	Res/Rés	Tim/Tmp	Code
D-9	Pavel PAVLOV	5	6	Andrew BROOKES	0 - 10	0:39	IPO
D-20	Pavel PAVLOV	5	7	Artur TARGOSINSKI	0 - 10	0:22	IPO
D-24	Andrew BROOKES	6	7	Artur TARGOSINSKI	0 - 10	1:00	IPO

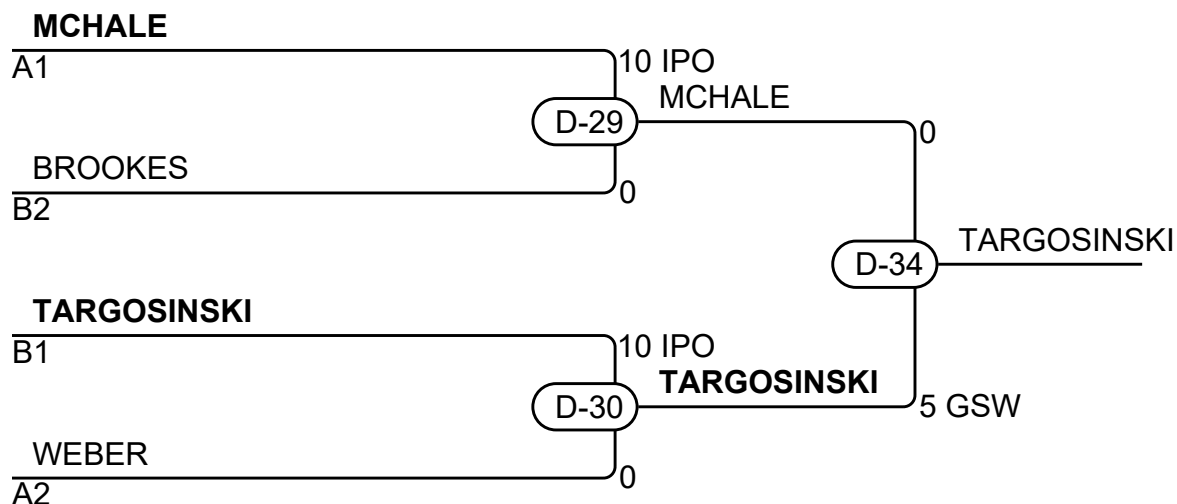

Results/Résultats

Pos	Name/Nom
1	Artur TARGOSINSKI, Full Circle
2	Brian MCHALE, Takahashi
3	Andrew BROOKES, Quinte
3	Kyle WEBER, Fudoshin

Veterans Male -81kg

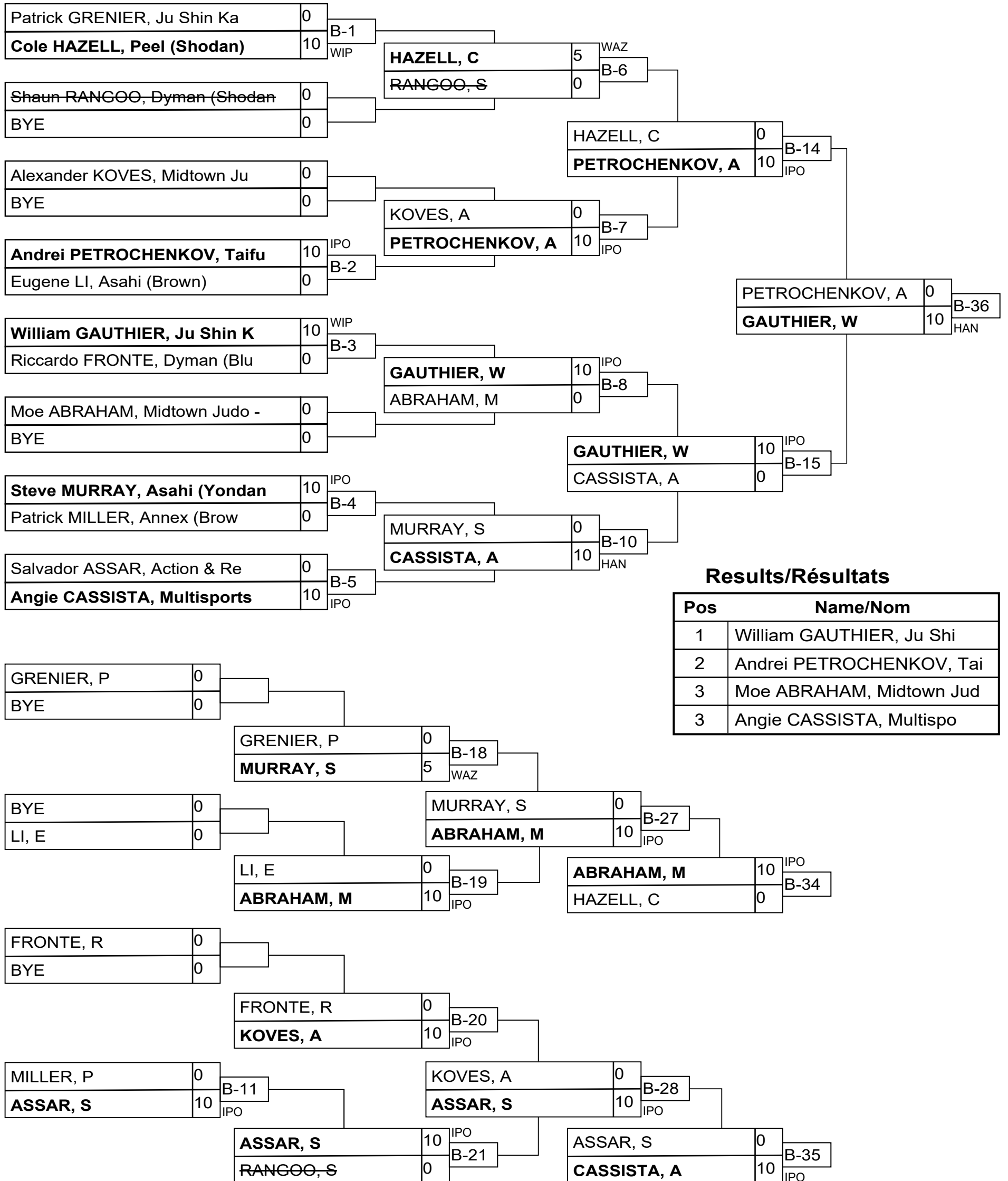

Results/Résultats

Pos	Name/Nom
1	William GAUTHIER, Ju Shi
2	Andrei PETROCHENKOV, Tai
3	Moe ABRAHAM, Midtown Jud
3	Angie CASSISTA, Multispo

Veterans Male -90kg

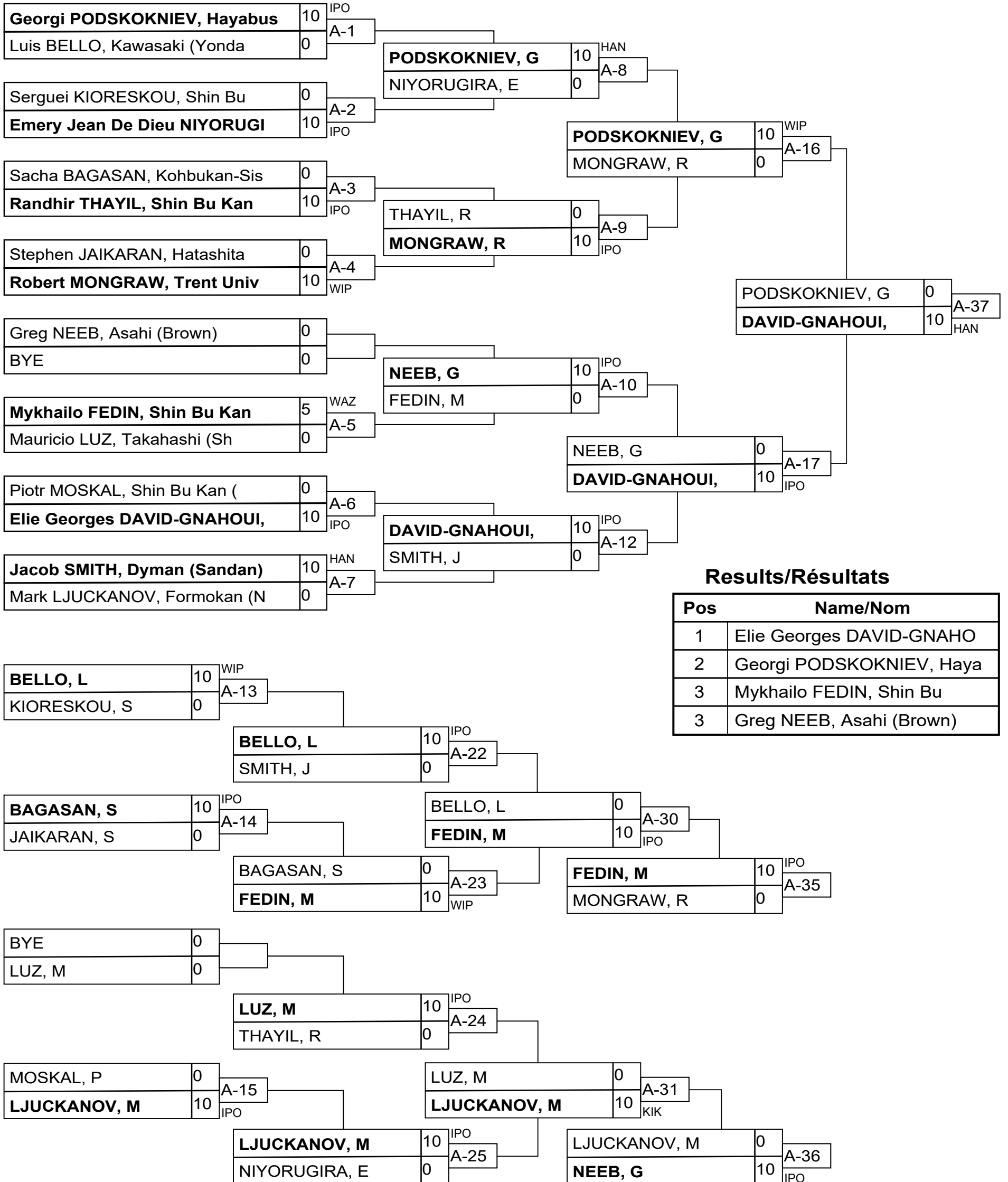

Results/Résultats

Pos	Name/Nom
1	Elie Georges DAVID-GNAHO
2	Georgi PODSKOKNIEV, Haya
3	Mykhailo FEDIN, Shin Bu
3	Greg NEEB, Asahi (Brown)

Veterans Male -100kg

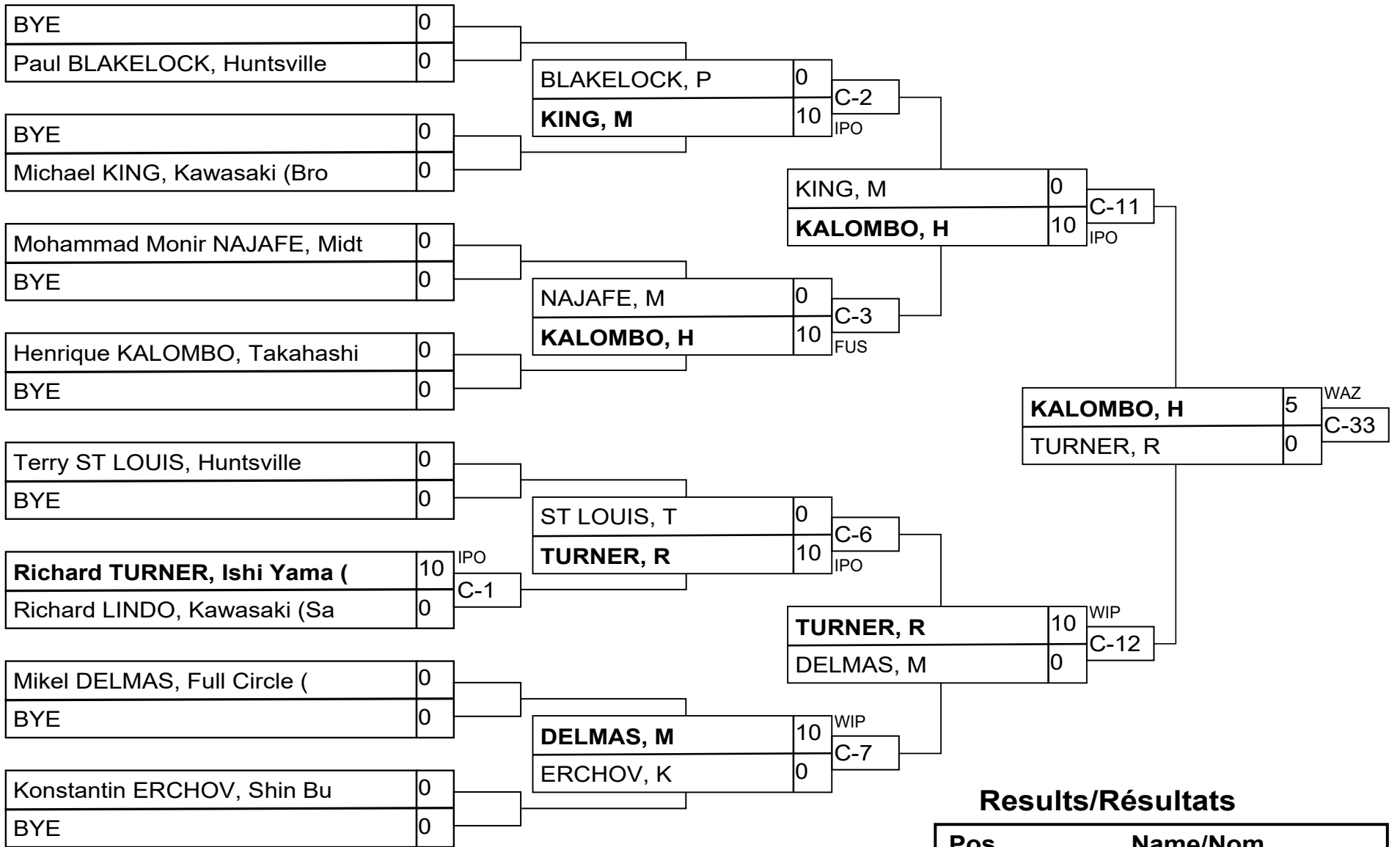

Results/Résultats

Pos	Name/Nom
1	Henrique KALOMBO, Takaha
2	Richard TURNER, Ishi Yam
3	Michael KING, Kawasaki (
3	Paul BLAKELOCK, Huntsvil

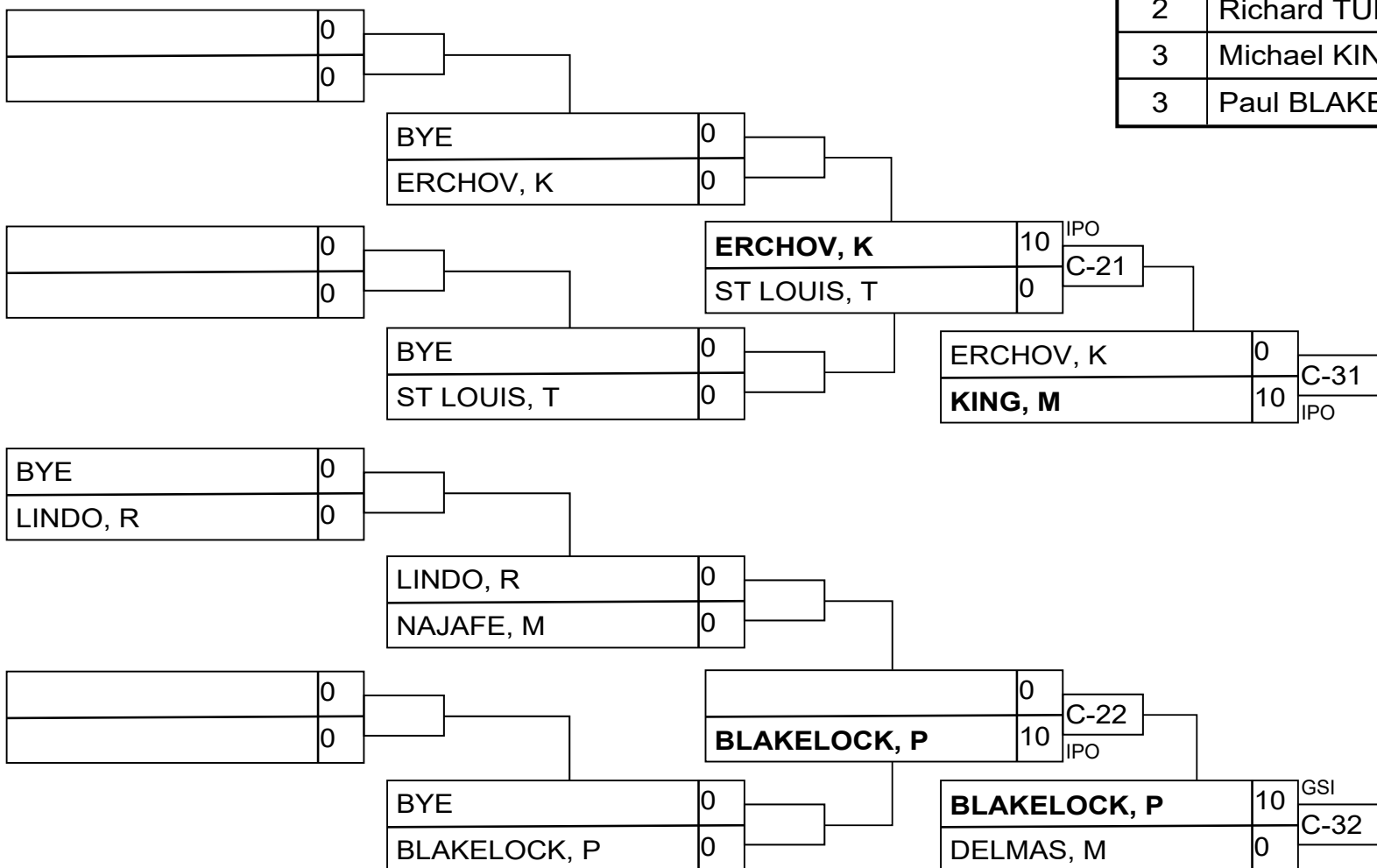

Veterans Male +100kg

Competitors/Compétiteurs

#	Name/Nom	Grade	Club	1	2	3	W/G	Pts	Pos
1	Jeff ALLEN	Shodan	Huntsville	XX			0	0	3
2	Huy TRUONG	Shodan	Judo Kai	5	XX		1	5	2
3	Vasfi ALIYEV	Sandan	Hiro's	10	10	XX	2	20	1

Matches/Matches

Match	White/Blanc			Blue/Bleu	Res/Rés	Tim/Tmp	Code
D-3	Jeff ALLEN	1	2	Huy TRUONG	0 - 5	3:00	WAZ
D-14	Jeff ALLEN	1	3	Vasfi ALIYEV	0 - 10	1:17	IPO
D-25	Huy TRUONG	2	3	Vasfi ALIYEV	0 - 10	2:11	IPO

Results/Résultats

Pos	Name/Nom
1	Vasfi ALIYEV, Hiro's
2	Huy TRUONG, Judo Kai

U18 Female -44kg

Competitors/Compétiteurs

#	Name/Nom	Grade	Club	1	2	1	2	1	2	W/G	Pts	Pos
1	Jaelyn ABRAHAM	Green	Scarborough	XX		XX		XX		0	0	2
2	Maya ROY	Brown	Val-des-Sources-Danville	10	XX	10	XX		XX	2	20	1

Matches/Matches

Match	White/Blanc			Blue/Bleu	Res/Rés	Tim/Tmp	Code
E-49	Jaelyn ABRAHAM	1	2	Maya ROY	0 - 10	2:24	HAN
E-63	Maya ROY	2	1	Jaelyn ABRAHAM	10 - 0	1:10	WIP
E-79	Jaelyn ABRAHAM	1	2	Maya ROY			

Results/Résultats

Pos	Name/Nom
1	Maya ROY, Val-des-Sources-Danville

U18 Female -48kg

Competitors/Compétiteurs A

#	Name/Nom	Grade	Club	1	2	3	4	W/G	Pts	Pos
1	Wish KEIRSTEAD	Brown	Pacific Kodokan Dojo	XX			10	1	10	3
2	Addyson TAMURA	Brown	Lethbridge	10	XX	10	10	3	30	1
3	Christina KARAS	Blue	Kodokwai	10		XX	10	2	20	2
4	Sophia DIMOCK	Blue	Trent Univ Judo Club				XX	0	0	4

Pool A

Match	White/Blanc	Blue/Bleu	Res/Rés	Tim/Tmp	Code
E-54	Wish KEIRSTEAD 1 2	Addyson TAMURA	0 - 10	3:28	IPO
E-55	Christina KARAS 3 4	Sophia DIMOCK	10 - 0	1:14	IPO
E-72	Wish KEIRSTEAD 1 3	Christina KARAS	0 - 10	3:33	HAN
E-73	Addyson TAMURA 2 4	Sophia DIMOCK	10 - 0	0:13	IPO
E-84	Wish KEIRSTEAD 1 4	Sophia DIMOCK	10 - 0	0:09	IPO
E-85	Addyson TAMURA 2 3	Christina KARAS	10 - 0	1:56	IPO

Competitors/Compétiteurs B

#	Name/Nom	Grade	Club	5	6	7	W/G	Pts	Pos
5	Camryn VAUGHAN	Green	Asahi	XX			0	0	3
6	Marisol SAVOIE	Brown	Otoshi Dieppe	10	XX		1	10	2
7	Valeria KOSTROVETS	Brown	Métropolitain	10	10	XX	2	20	1

Pool B

Match	White/Blanc	Blue/Bleu	Res/Rés	Tim/Tmp	Code
E-56	Camryn VAUGHAN 5 6	Marisol SAVOIE	0 - 10	0:42	IPO
E-74	Camryn VAUGHAN 5 7	Valeria KOSTROVETS	0 - 10	0:42	IPO
E-86	Marisol SAVOIE 6 7	Valeria KOSTROVETS	0 - 10	1:40	IPO

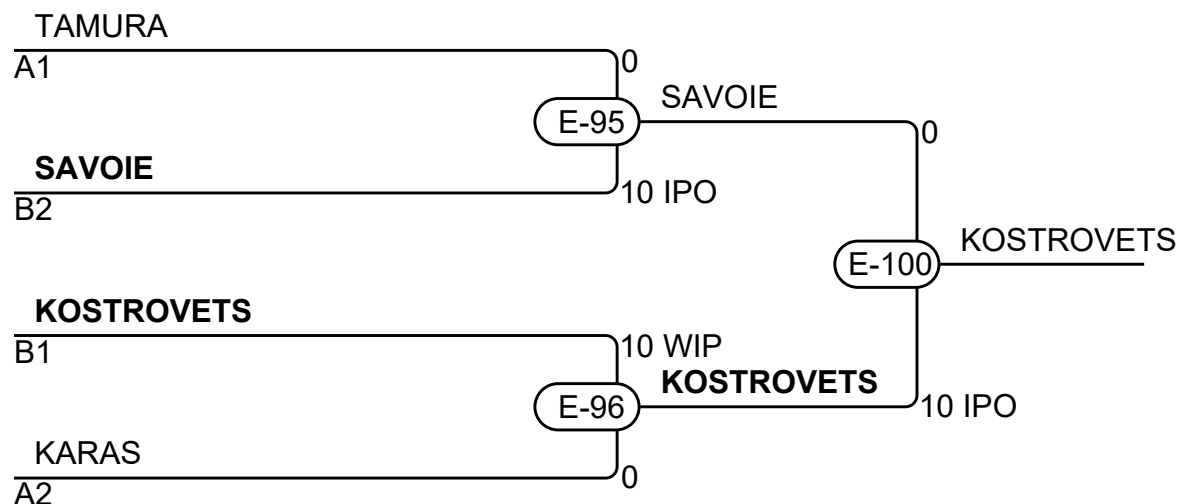

Results/Résultats

Pos	Name/Nom
1	Valeria KOSTROVETS, Métropolitain
2	Marisol SAVOIE, Otoshi Dieppe
3	Addyson TAMURA, Lethbridge
3	Christina KARAS, Kodokwai

U18 Female -52kg

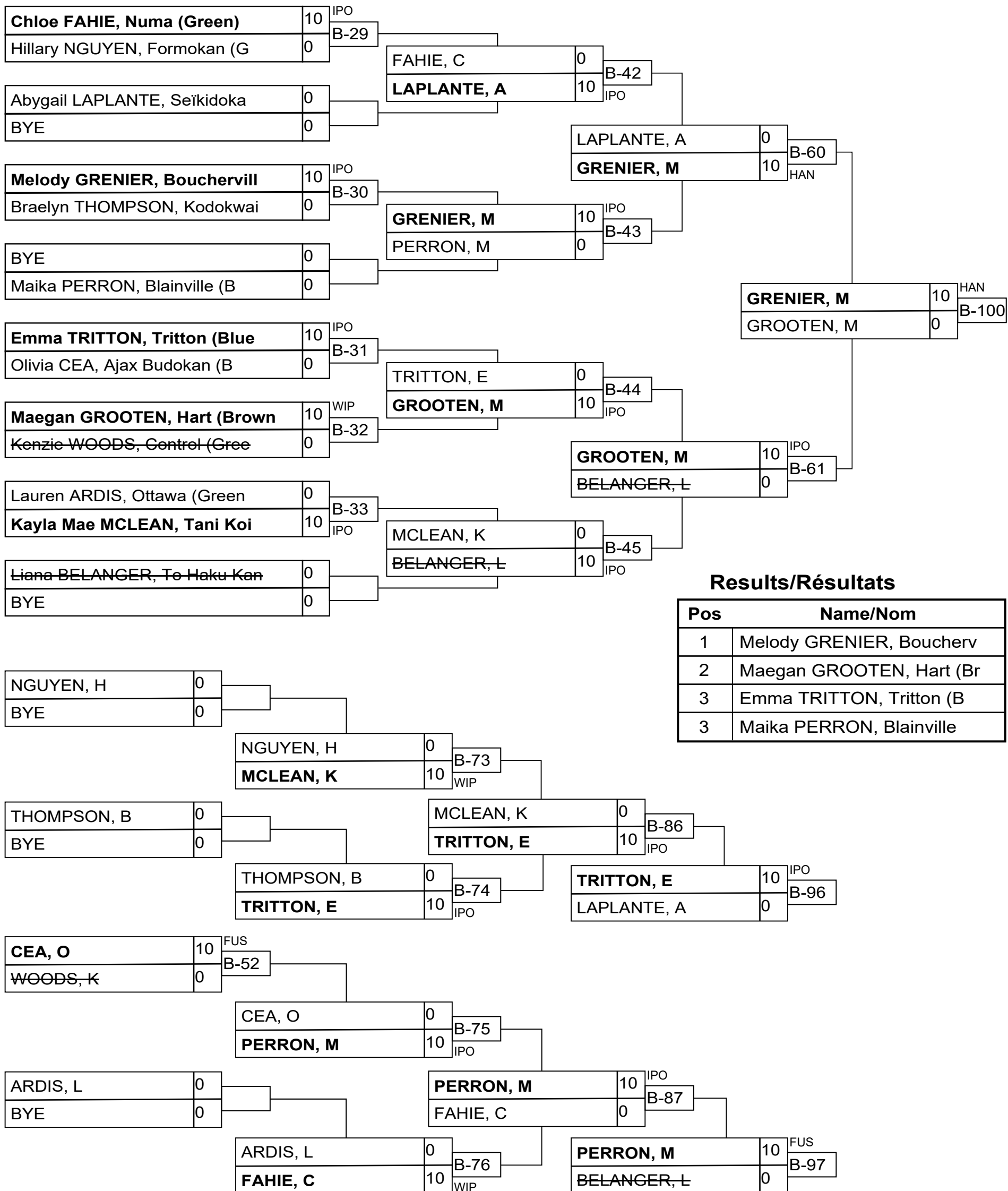

Results/Résultats

Pos	Name/Nom
1	Melody GRENIER, Boucherv
2	Maegan GROOTEN, Hart (Br
3	Emma TRITTON, Tritton (B
3	Maika PERRON, Blainville

U18 Female -57kg

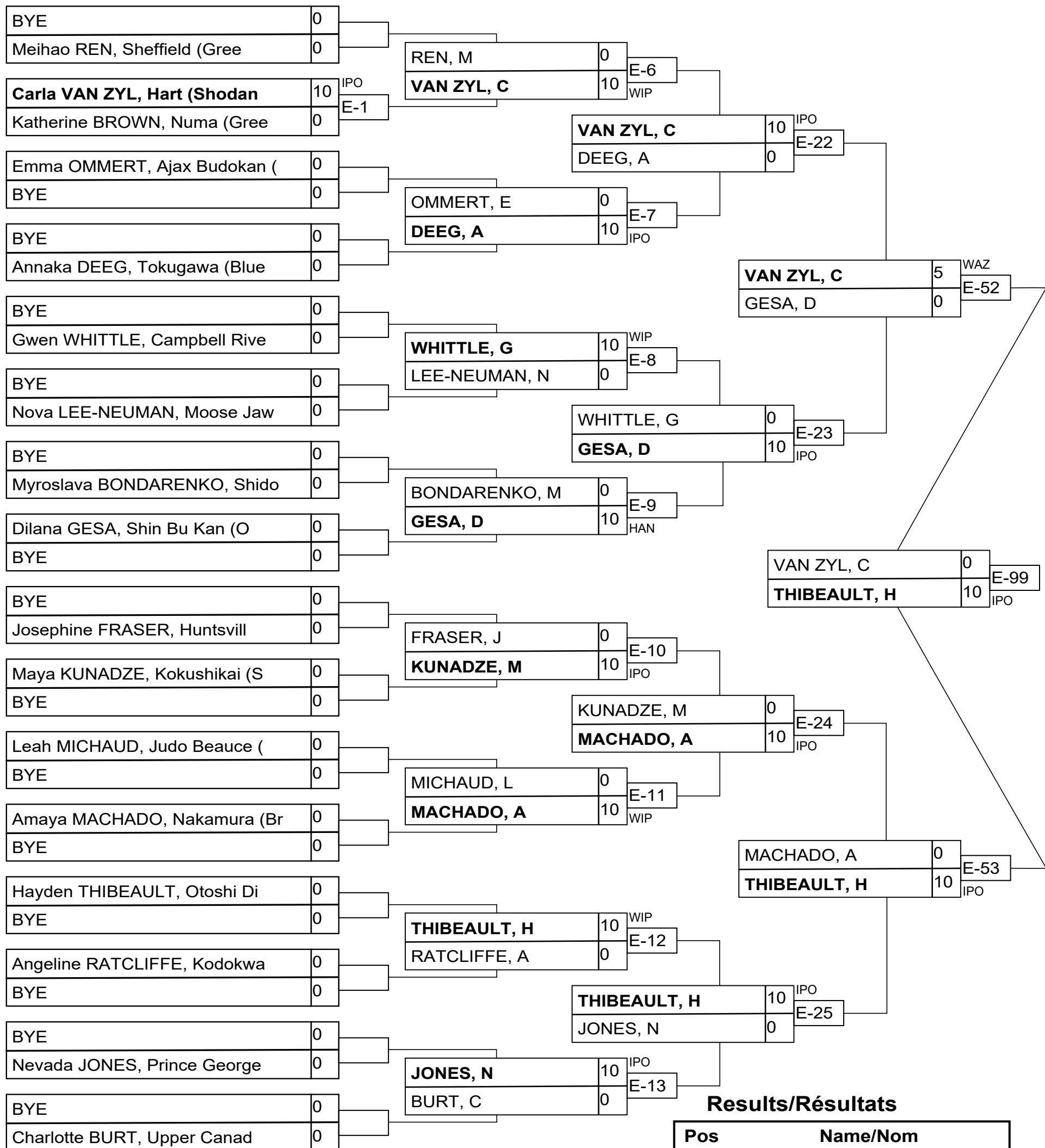

Results/Résultats

Pos	Name/Nom
1	Hayden THIBEAULT, Otoshi
2	Carla VAN ZYL, Hart (Sho)
3	Myroslava BONDARENKO, Sh
3	Amaya MACHADO, Nakamura

U18 Female -57kg

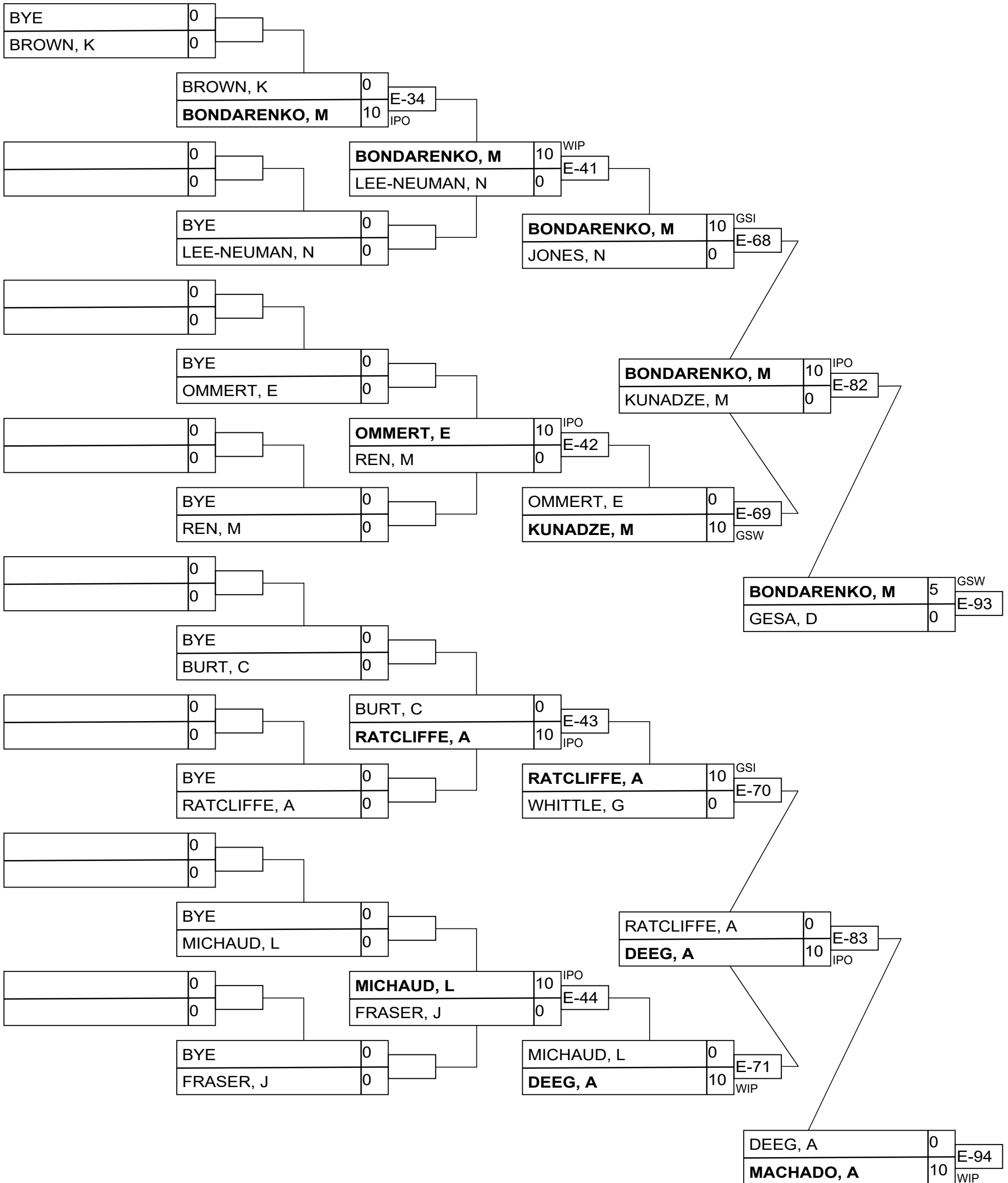

U18 Female -63kg

Competitors/Compétiteurs A

#	Name/Nom	Grade	Club	1	2	3	4	W/G	Pts	Pos
1	Alythea KARSERAS	Brown	Takahashi	XX		10		1	10	3
2	Charlie THIBAULT	Brown	Seikidokan (QC)	10	XX	10	10	3	30	1
3	Nadya FRANCIS	Brown	Fudoshin			XX		0	0	4
4	Rylee SULLIVAN	Blue	Jason Morris Judo Centre	10		10	XX	2	20	2

Pool A

Match	White/Blanc	Blue/Bleu	Res/Rés	Tim/Tmp	Code
B-55	Alythea KARSERAS 1 2	Charlie THIBAULT	0 - 10	0:45	IPO
B-56	Nadya FRANCIS 3 4	Rylee SULLIVAN	0 - 10	0:10	IPO
B-66	Alythea KARSERAS 1 3	Nadya FRANCIS	10 - 0	0:41	WIP
B-67	Charlie THIBAULT 2 4	Rylee SULLIVAN	10 - 0	0:16	IPO
B-81	Alythea KARSERAS 1 4	Rylee SULLIVAN	0 - 10	1:09	IPO
B-82	Charlie THIBAULT 2 3	Nadya FRANCIS	10 - 0	0:09	IPO

Competitors/Compétiteurs B

#	Name/Nom	Grade	Club	5	6	7	W/G	Pts	Pos
5	Jaida ADDO	Blue	Takahashi	XX			0	0	3
6	Alandra STEIGER	Brown	Prince George	10	XX	10	2	20	1
7	Alexia FRECHETTE	Brown	Seikidokan (QC)	10		XX	1	10	2

Pool B

Match	White/Blanc	Blue/Bleu	Res/Rés	Tim/Tmp	Code
B-57	Jaida ADDO 5 6	Alandra STEIGER	0 - 10	0:50	WIP
B-68	Jaida ADDO 5 7	Alexia FRECHETTE	0 - 10	0:07	IPO
B-83	Alandra STEIGER 6 7	Alexia FRECHETTE	10 - 0	1:09	IPO

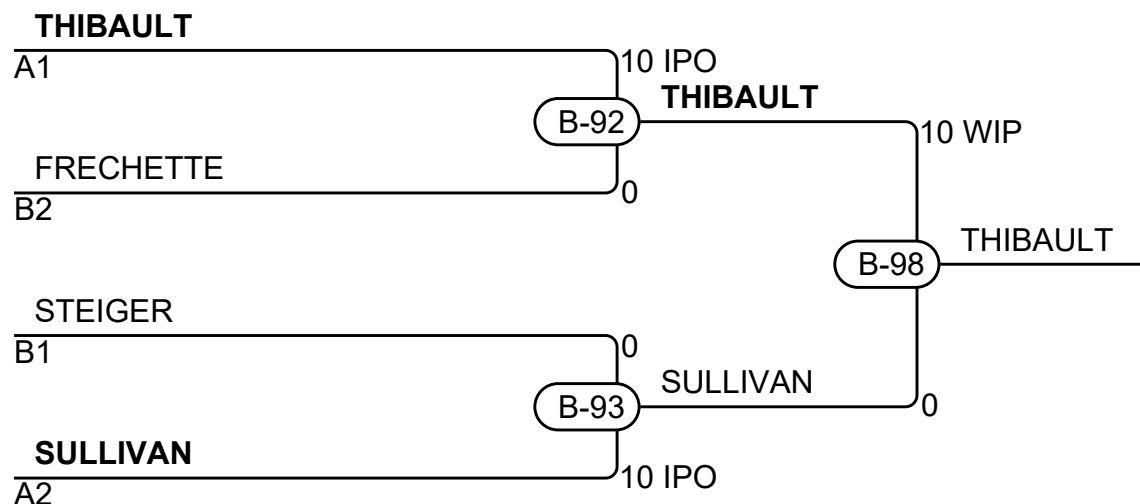

Results/Résultats

Pos	Name/Nom
1	Charlie THIBAULT, Seikidokan (QC)
2	Rylee SULLIVAN, Jason Morris Judo Centre
3	Alexia FRECHETTE, Seikidokan (QC)
3	Alandra STEIGER, Prince George

U18 Female -70kg

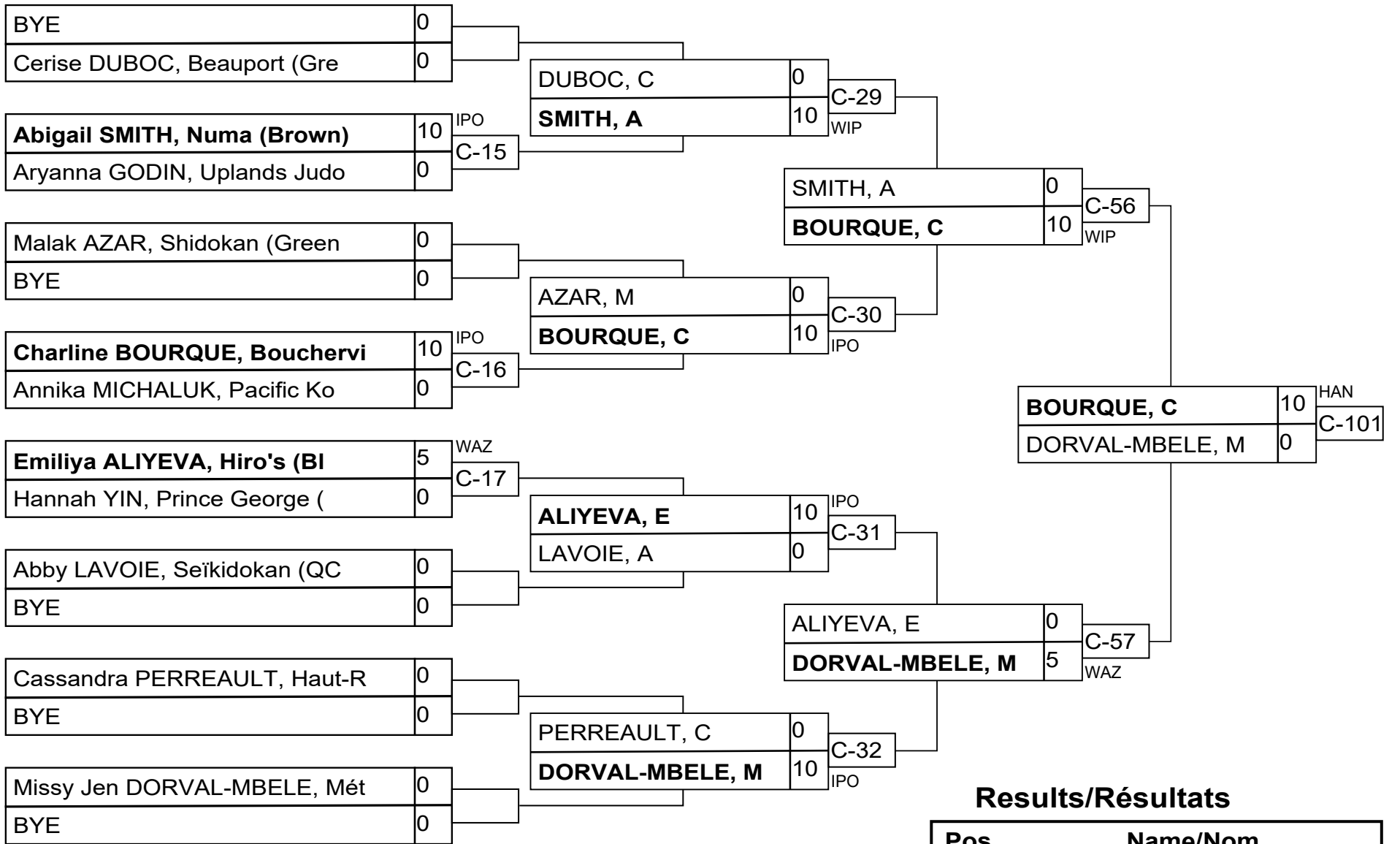

Results/Résultats

Pos	Name/Nom
1	Charline BOURQUE, Bouche
2	Missy Jen DORVAL-MBELE,
3	Abigail SMITH, Numa (Bro
3	Emiliya ALIYEVA, Hiro's

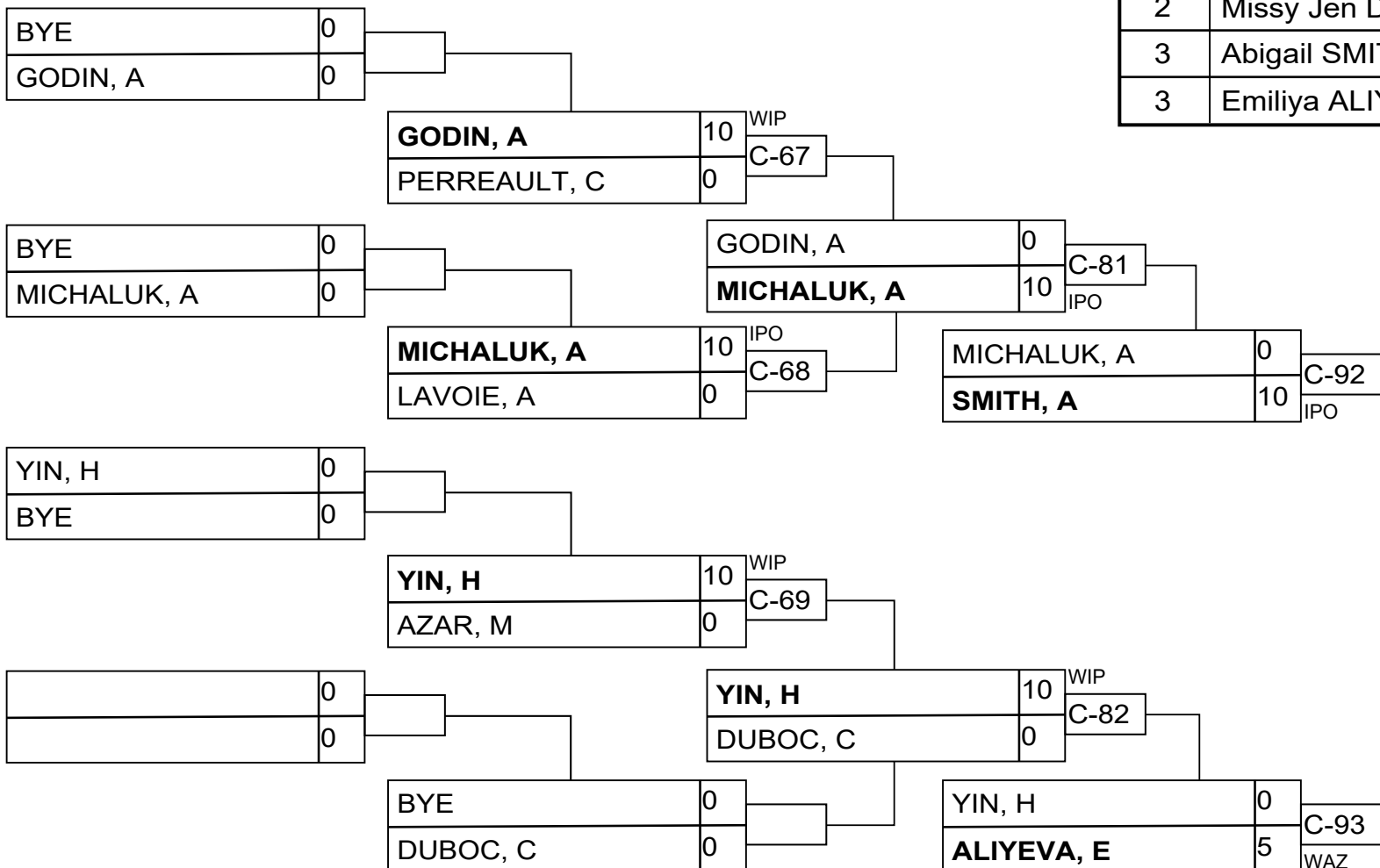

U18 Female +70kg

Competitors/Compétiteurs

#	Name/Nom	Grade	Club	1	2	3	4	5	W/G	Pts	Pos
1	Emily HARRIS	Brown	Mountainside	XX		10			1	10	4
2	Kandice VERGE	Blue	Spryfield	10	XX	10	10		3	30	2
3	Lilea MCKAY	Brown	Huntsville			XX			0	0	5
4	Kathleen SIMMONDS	Brown	Fort Providence	10		10	XX		2	20	3
5	Naomi FOWLER	Brown	Tani Koi	10	10	10	10	XX	4	40	1

Matches/Matches

Match	White/Blanc			Blue/Bleu	Res/Rés	Tim/Tmp	Code
E-35	Kathleen SIMMONDS	4	5	Naomi FOWLER	0 - 10	0:07	IPO
E-36	Emily HARRIS	1	2	Kandice VERGE	0 - 10	2:16	IPO
E-45	Lilea MCKAY	3	4	Kathleen SIMMONDS	0 - 10	0:16	IPO
E-46	Emily HARRIS	1	5	Naomi FOWLER	0 - 10	1:05	IPO
E-57	Kandice VERGE	2	3	Lilea MCKAY	10 - 0	0:36	WIP
E-58	Emily HARRIS	1	4	Kathleen SIMMONDS	0 - 10	0:11	IPO
E-75	Lilea MCKAY	3	5	Naomi FOWLER	0 - 10	0:00	FUS
E-76	Kandice VERGE	2	4	Kathleen SIMMONDS	10 - 0	3:29	HAN
E-87	Emily HARRIS	1	3	Lilea MCKAY	10 - 0	0:00	IPO
E-88	Kandice VERGE	2	5	Naomi FOWLER	0 - 10	1:10	IPO

Results/Résultats

Pos	Name/Nom
1	Naomi FOWLER, Tani Koi
2	Kandice VERGE, Spryfield
3	Kathleen SIMMONDS, Fort Providence
4	Emily HARRIS, Mountainside

U18 Male -50kg

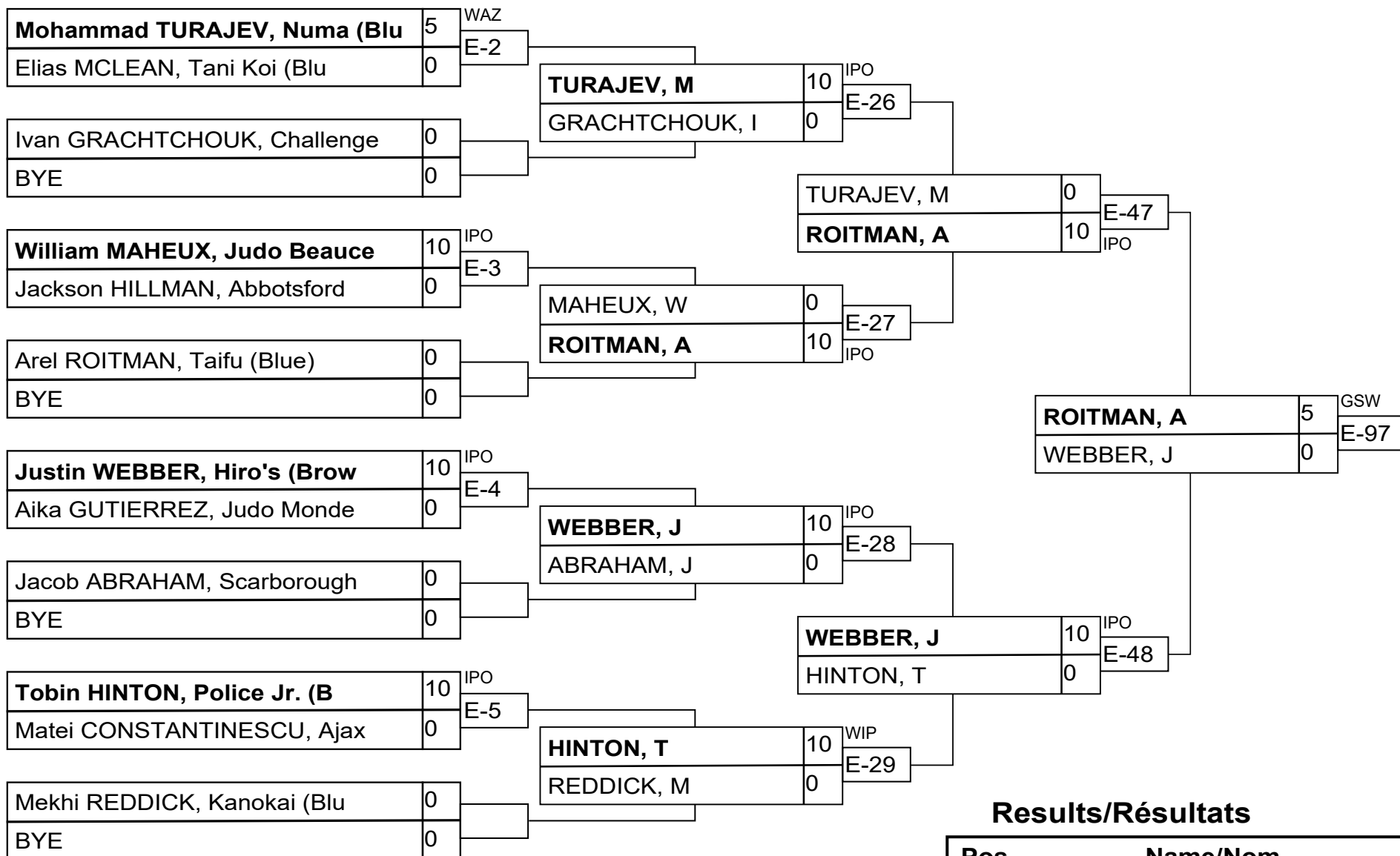

Results/Résultats

Pos	Name/Nom
1	Arel ROITMAN, Taifu (Blu
2	Justin WEBBER, Hiro's (B
3	Elias MCLEAN, Tani Koi (
3	Ivan GRACHTCHOUK, Challe

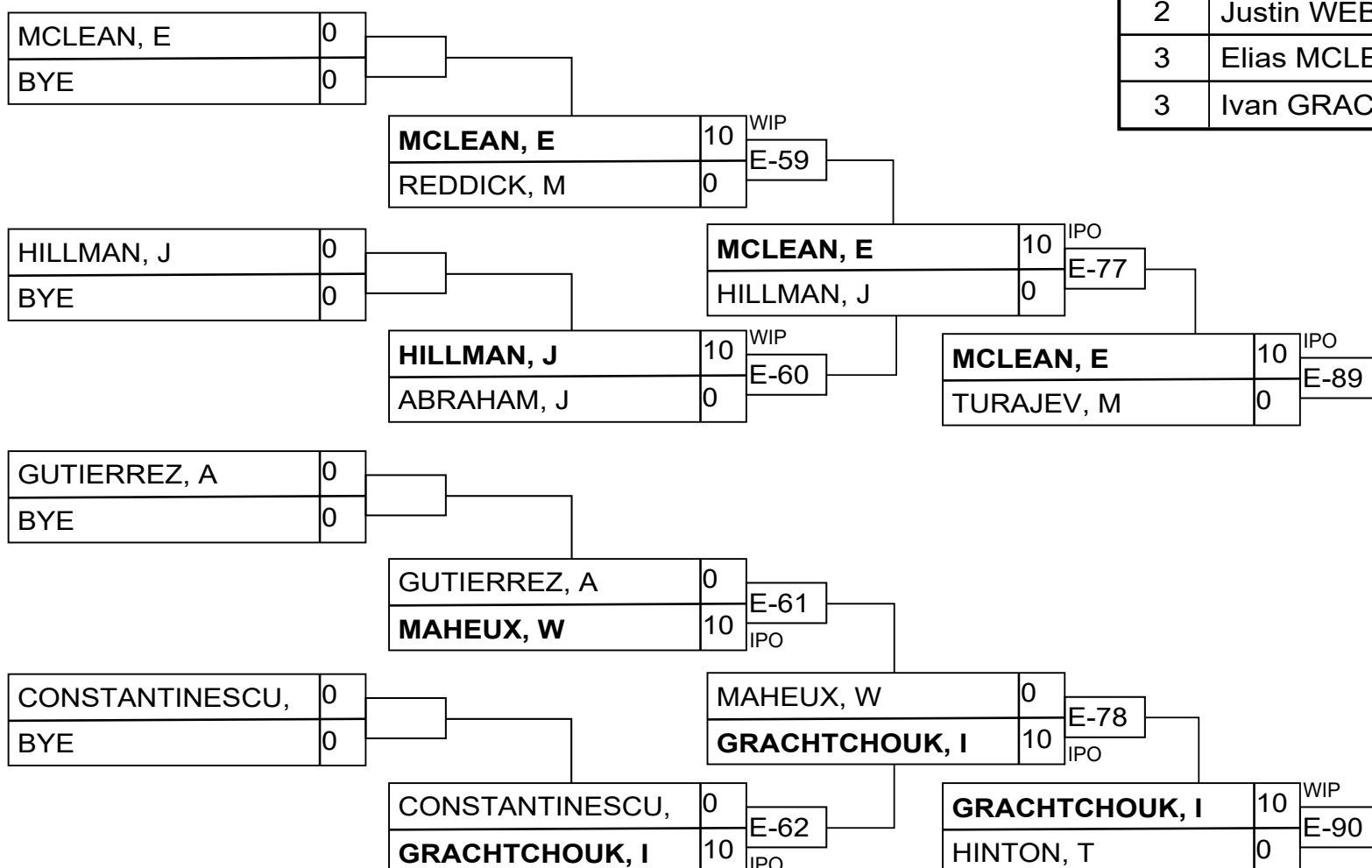

U18 Male -55kg

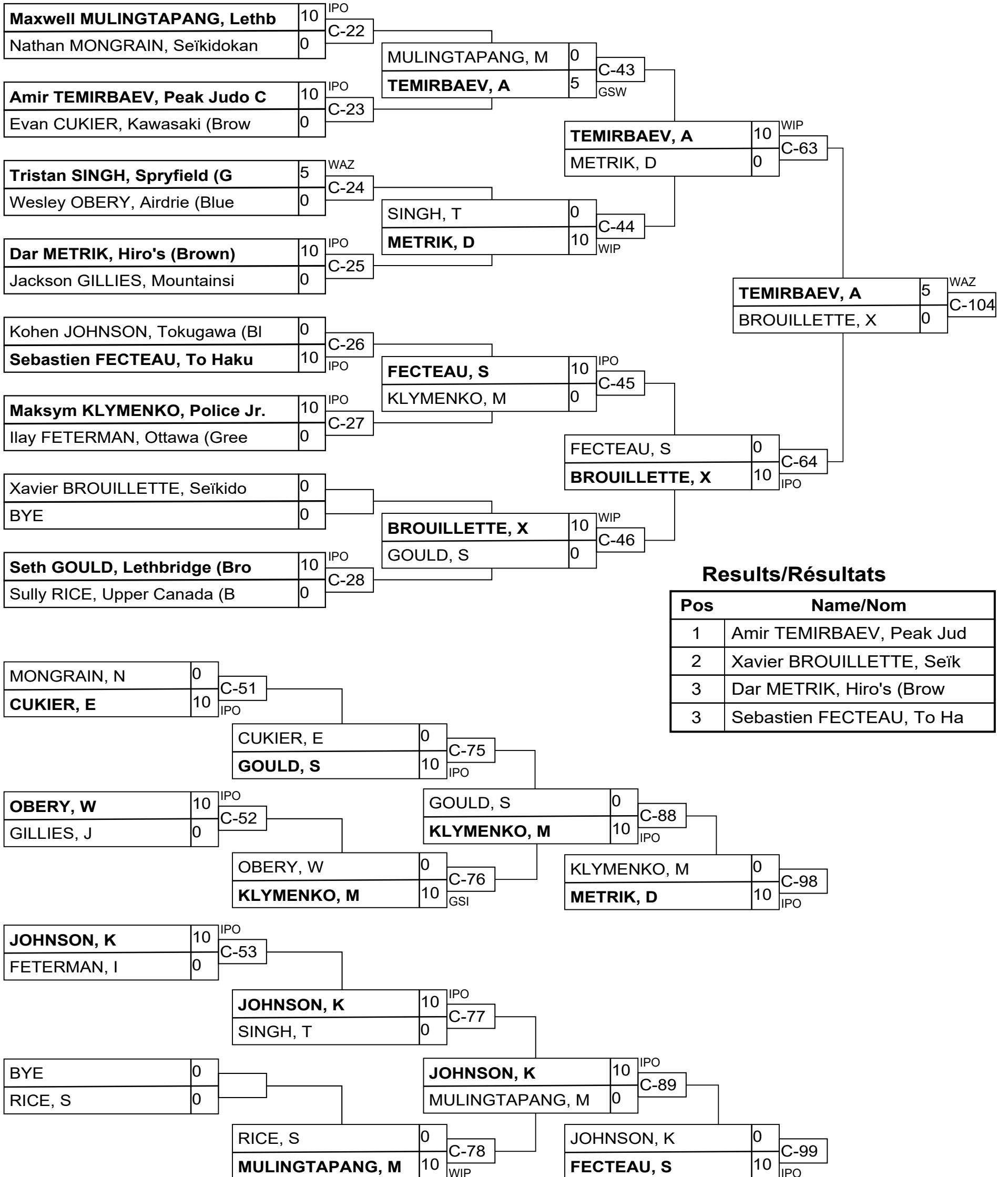

U18 Male -60kg

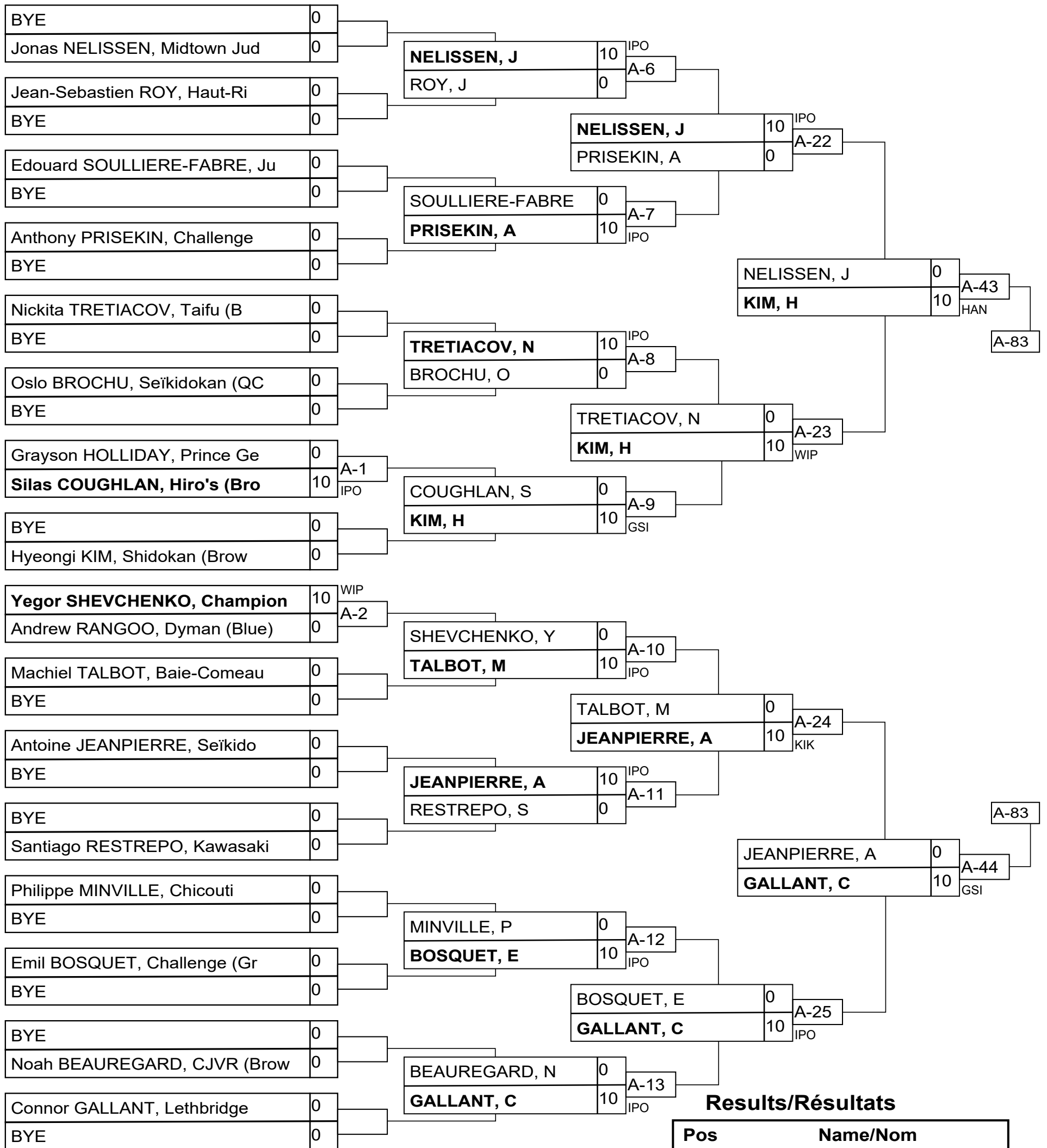

Results/Résultats

Pos	Name/Nom
1	Hyeongi KIM, Shidokan (B
2	Matthew SCHESNUIK, Judo
3	Aden KIM, Lethbridge (Br
3	Antoine JEANPIERRE, Seik

U18 Male -60kg

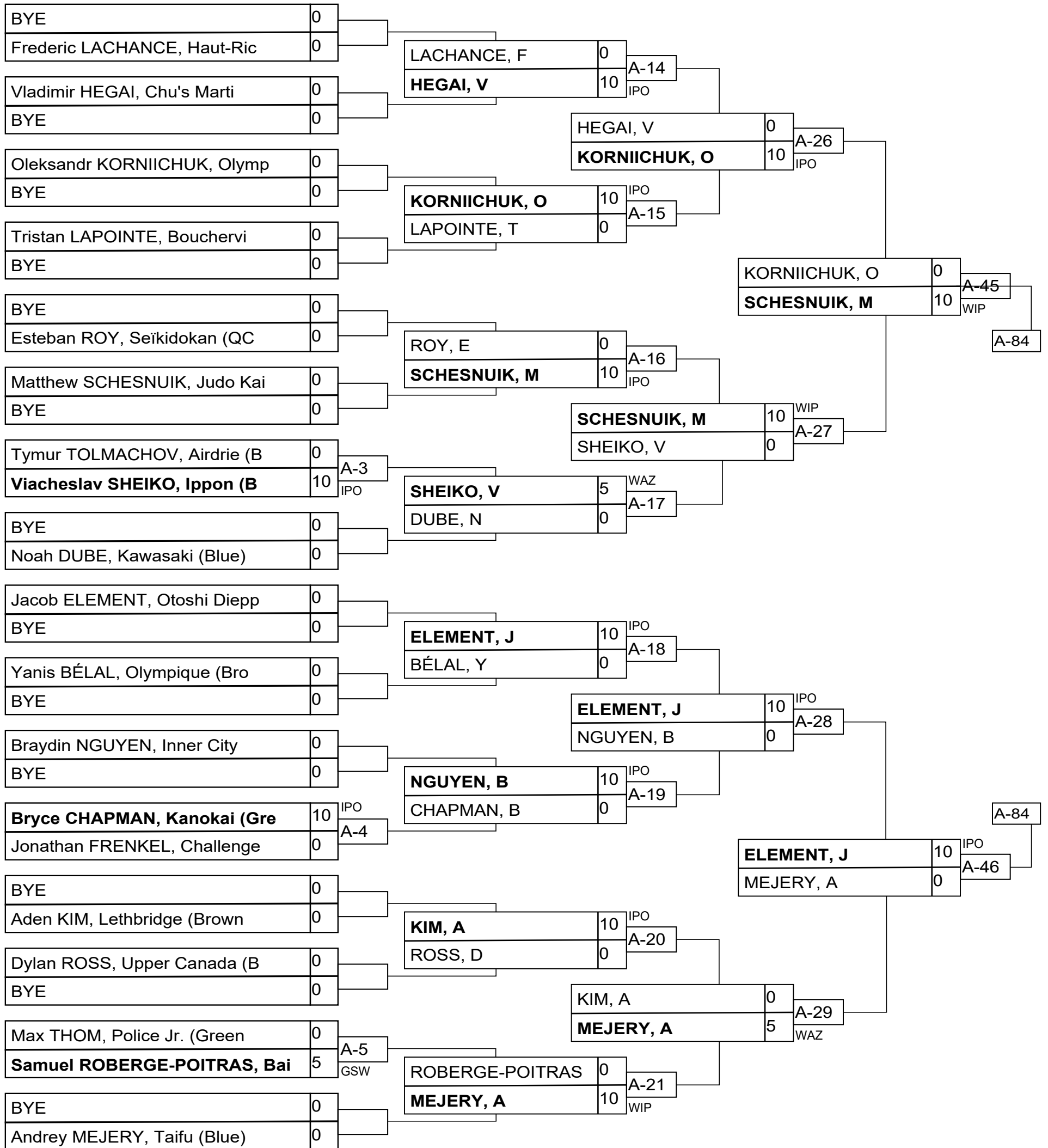

U18 Male -60kg

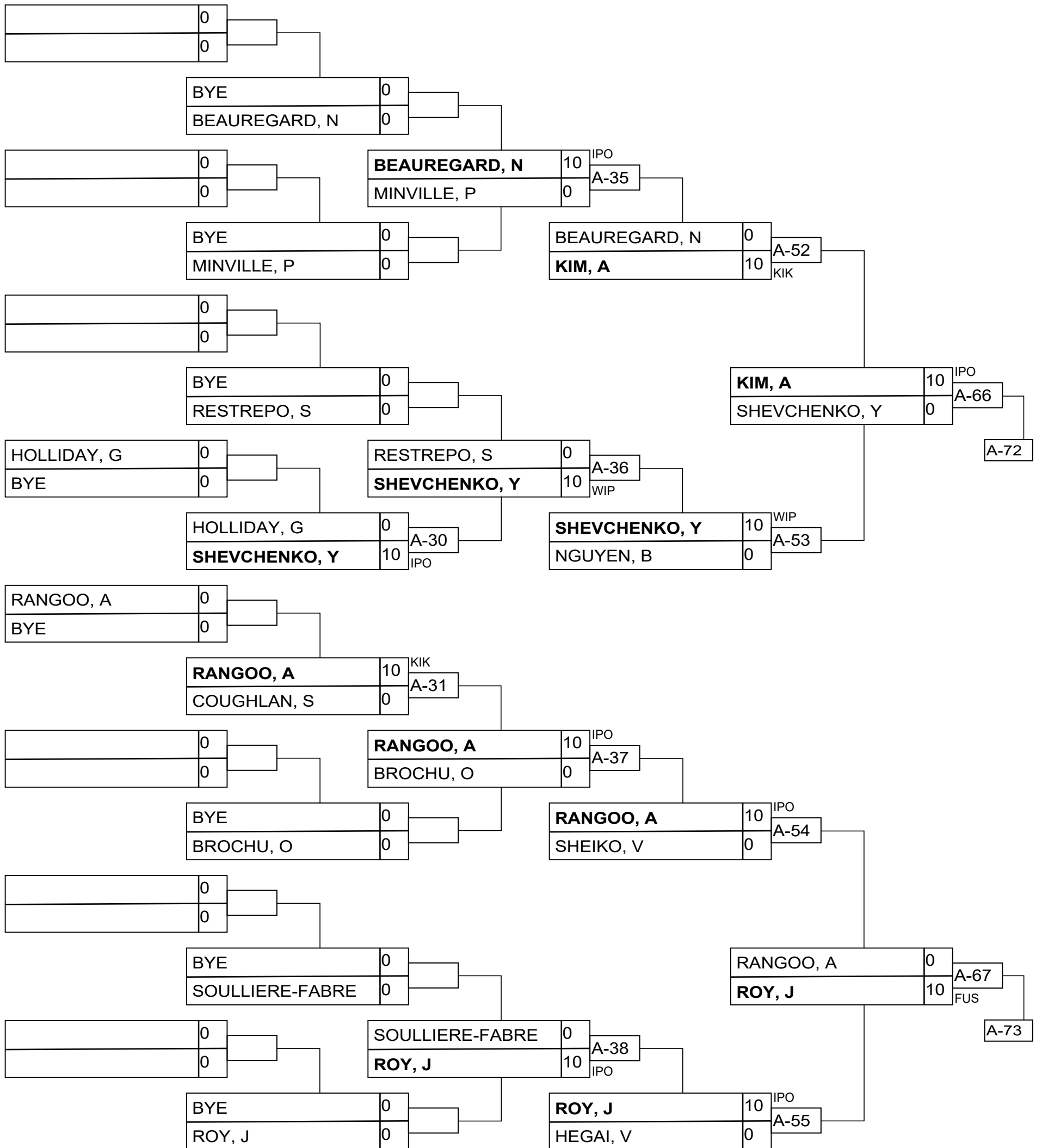

U18 Male -60kg

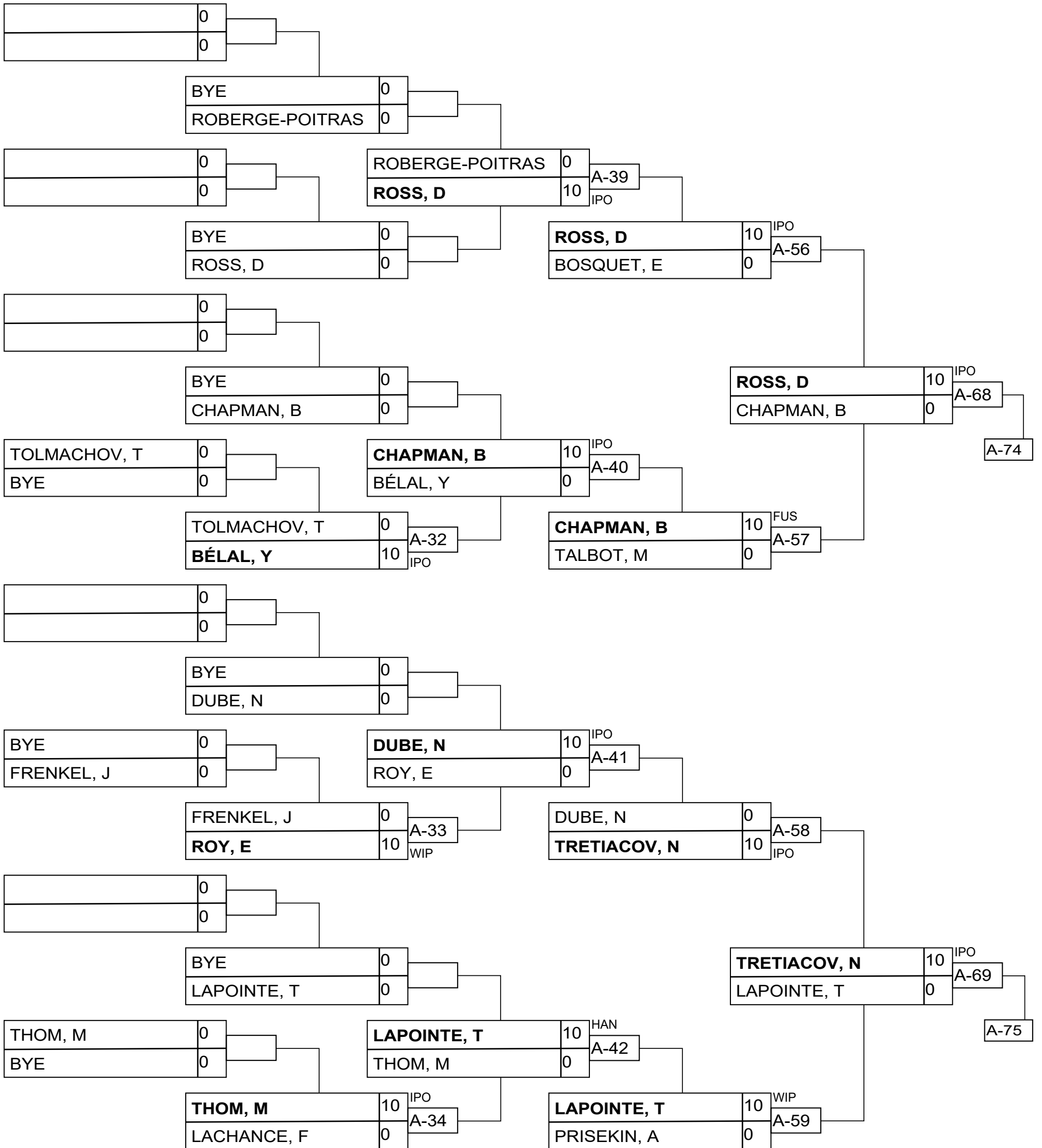

U18 Male -60kg

KIM, H	10
GALLANT, C	0

IPO
A-83

KIM, H	10
SCHESNUIK, M	0

IPO
A-104

SCHESNUIK, M	5
ELEMENT, J	0

GSW
A-84

KIM, A	10
KORNIICHUK, O	0

WIP
A-72

KIM, A	10
MEJERY, A	0

HAN
A-93

ROY, J	0
MEJERY, A	10

A-73
GSI

KIM, A	10
ELEMENT, J	0

IPO
A-100

ROSS, D	0
NELISSEN, J	10

A-74
IPO

NELISSEN, J	0
JEANPIERRE, A	10

A-94
IPO

TRETIACOV, N	0
JEANPIERRE, A	10

A-75
WIP

JEANPIERRE, A	10
GALLANT, C	0

IPO
A-101

U18 Male -66kg

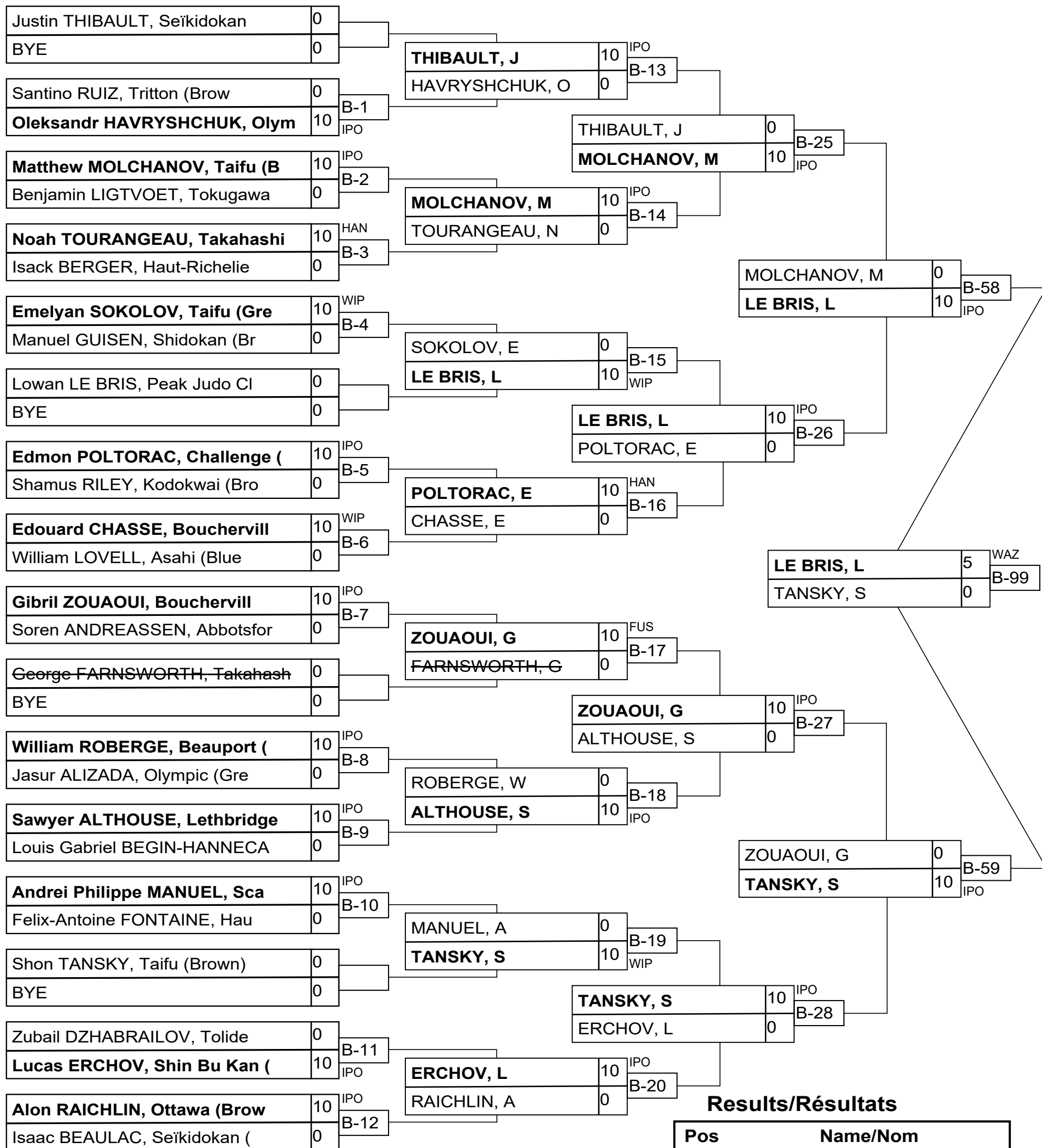

Results/Résultats

Pos	Name/Nom
1	Lowan LE BRIS, Peak Judo
2	Shon TANSKY, Taifu (Brow)
3	Sawyer ALTHOUSE, Lethbri
3	Gibril ZOUAOUI, Boucherv

U18 Male -66kg

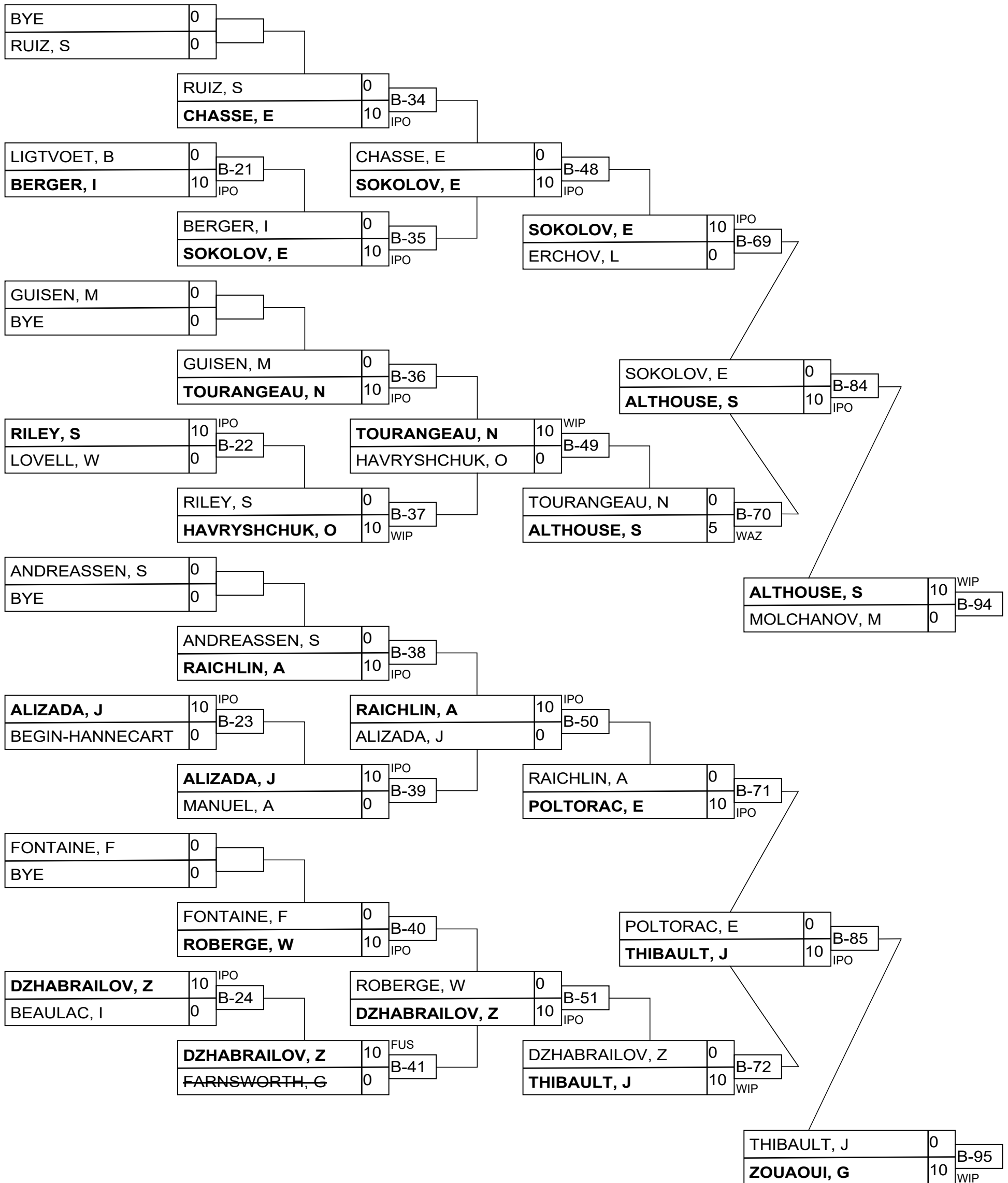

U18 Male -73kg

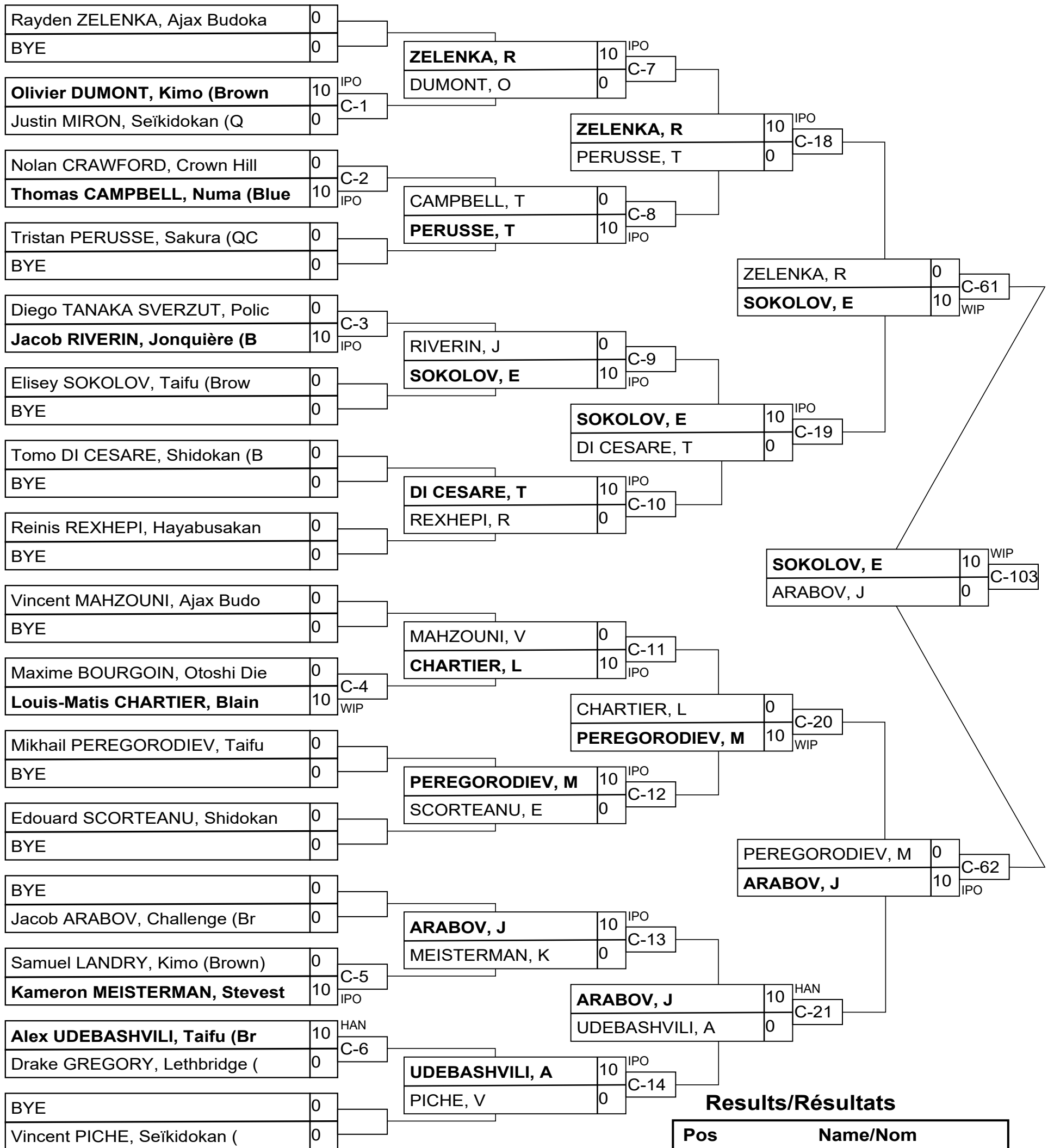

Results/Résultats

Pos	Name/Nom
1	Elisey SOKOLOV, Taifu (B)
2	Jacob ARABOV, Challenge
3	Louis-Matis CHARTIER, BI
3	Edouard SCORTEANU, Shido

U18 Male -73kg

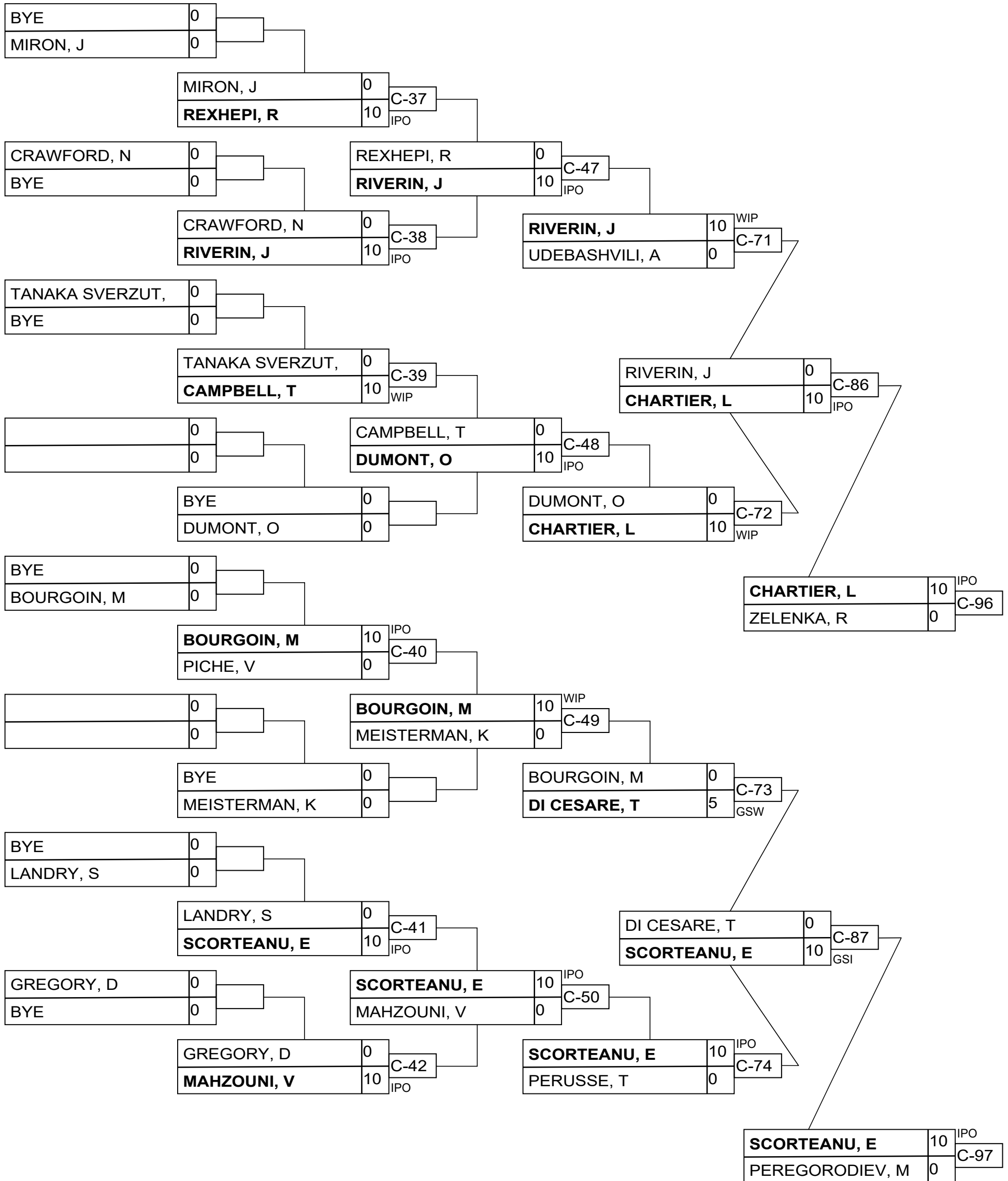

U18 Male -90kg

Competitors/Compétiteurs

#	Name/Nom	Grade	Club	1	2	3	4	5	W/G	Pts	Pos
1	Andrew MAHEUX-DYER	Blue	Beauport	XX			10		1	10	4
2	Munkhu BATBAYAR	Brown	Lethbridge	10	XX	10	10	10	4	40	1
3	Franck David MOUSSIMA EWAN	Green	Ippon	10		XX	10		2	20	3
4	Kingston ALEXANDER	Blue	Judokaa				XX		0	0	5
5	Eden KHALFON	Brown	Taifu	10		5	10	XX	3	25	2

Matches/Matches

Match	White/Blanc			Blue/Bleu	Res/Rés	Tim/Tmp	Code
A-50	Kingston ALEXANDER	4	5	Eden KHALFON	0 - 10	1:59	IPO
A-51	Andrew MAHEUX-DYER	1	2	Munkhu BATBAYAR	0 - 10	1:44	IPO
A-64	Franck David MOUSSIMA EWANE ELOU	3	4	Kingston ALEXANDER	10 - 0	0:49	IPO
A-65	Andrew MAHEUX-DYER	1	5	Eden KHALFON	0 - 10	1:17	IPO
A-70	Munkhu BATBAYAR	2	3	Franck David MOUSSIMA EWANE ELOUT	10 - 0	3:04	IPO
A-71	Andrew MAHEUX-DYER	1	4	Kingston ALEXANDER	10 - 0	0:40	WIP
A-81	Franck David MOUSSIMA EWANE ELOUT	3	5	Eden KHALFON	0 - 5	4:00	WAZ
A-82	Munkhu BATBAYAR	2	4	Kingston ALEXANDER	10 - 0	1:09	IPO
A-91	Andrew MAHEUX-DYER	1	3	Franck David MOUSSIMA EWANE ELOU	0 - 10	1:26	WIP
A-92	Munkhu BATBAYAR	2	5	Eden KHALFON	10 - 0	1:09	IPO

Results/Résultats

Pos	Name/Nom
1	Munkhu BATBAYAR, Lethbridge
2	Eden KHALFON, Taifu
3	Franck David MOUSSIMA EWANE ELOUTI, Ippon
4	Andrew MAHEUX-DYER, Beauport

U18 Male +90kg

Competitors/Compétiteurs

#	Name/Nom	Grade	Club	1	2	1	2	1	2	W/G	Pts	Pos
1	Cai JAMES	Blue	Balmoral	XX		XX		XX		0	0	2
2	Mohamed Amine SILEM	Brown	Métropolitain	10	XX	10	XX		XX	2	20	1

Matches/Matches

Match	White/Blanc			Blue/Bleu	Res/Rés	Tim/Tmp	Code
D-61	Cai JAMES	1	2	Mohamed Amine SILEM	0 - 10	0:23	IPO
D-76	Mohamed Amine SILEM	2	1	Cai JAMES	10 - 0	0:46	IPO
D-87	Cai JAMES	1	2	Mohamed Amine SILEM			

Results/Résultats

Pos	Name/Nom
1	Mohamed Amine SILEM, Métropolitain

U21 Female -48kg

Competitors/Compétiteurs

#	Name/Nom	Grade	Club	1	2	3	W/G	Pts	Pos
1	Angelina MCCRISTALL	Shodan	Upper Canada	XX			0	0	3
2	Elizabeth SANIKIDZE	Blue	Tokugawa	5	XX		1	5	2
3	Marie-Lune TURMEL	Shodan	Blainville	10	10	XX	2	20	1

Matches/Matches

Match	White/Blanc			Blue/Bleu	Res/Rés	Tim/Tmp	Code
A-80	Angelina MCCRISTALL	1	2	Elizabeth SANIKIDZE	0 - 5	5:44	GSW
A-90	Angelina MCCRISTALL	1	3	Marie-Lune TURMEL	0 - 10	1:39	WIP
A-99	Elizabeth SANIKIDZE	2	3	Marie-Lune TURMEL	0 - 10	0:11	IPO

Results/Résultats

Pos	Name/Nom
1	Marie-Lune TURMEL, Blainville
2	Elizabeth SANIKIDZE, Tokugawa

U21 Female -52kg

Competitors/Compétiteurs

#	Name/Nom	Grade	Club	1	2	3	4	W/G	Pts	Pos
1	Avery GIBNEY	Shodan	Moose Jaw	XX			10	1	10	2
2	Laurence GAGNON	Shodan	Jonquière	10	XX	10	10	3	30	1
3	Dasha TKACHENKO	Brown	Taifu	10		XX		1	10	3
4	Aida Miko SHIMA	Brown	Kodokwai			10	XX	1	10	4

Matches/Matches

Match	White/Blanc			Blue/Bleu	Res/Rés	Tim/Tmp	Code
B-64	Avery GIBNEY	1	2	Laurence GAGNON	0 - 10	2:36	WIP
B-95A	Dasha TKACHENKO	3	4	Aida Miko SHIMA	0 - 10	1:31	IPO
B-101	Avery GIBNEY	1	3	Dasha TKACHENKO	0 - 10	0:58	IPO
B-80	Laurence GAGNON	2	4	Aida Miko SHIMA	10 - 0	1:31	IPO
B-93A	Avery GIBNEY	1	4	Aida Miko SHIMA	10 - 0	0:34	IPO
B-91	Laurence GAGNON	2	3	Dasha TKACHENKO	10 - 0	5:17	HAN

Results/Résultats

Pos	Name/Nom
1	Laurence GAGNON, Jonquière
2	Avery GIBNEY, Moose Jaw
3	Dasha TKACHENKO, Taifu
4	Aida Miko SHIMA, Kodokwai

U21 Female -52kg (TB)

Competitors/Compétiteurs

#	Name/Nom	Grade	Club	1	2	3	W/G	Pts	Pos
1	Aida Miko SHIMA	Brown	Kodokwai	XX		10	1	10	3
2	Avery GIBNEY	Shodan	Moose Jaw	10	XX		1	10	1
3	Dasha TKACHENKO	Brown	Taifu		10	XX	1	10	2

Matches/Matches

Match	White/Blanc			Blue/Bleu	Res/Rés	Tim/Tmp	Code
B-93A	Aida Miko SHIMA	1	2	Avery GIBNEY	0 - 10	0:34	IPO
B-95A	Aida Miko SHIMA	1	3	Dasha TKACHENKO	10 - 0	1:31	IPO
B-101	Avery GIBNEY	2	3	Dasha TKACHENKO	0 - 10	0:58	IPO

Results/Résultats

Pos	Name/Nom
1	Avery GIBNEY, Moose Jaw
2	Dasha TKACHENKO, Taifu
3	Aida Miko SHIMA, Kodokwai

U21 Female -57kg

Competitors/Compétiteurs A

#	Name/Nom	Grade	Club	1	2	3	W/G	Pts	Pos
1	Camilia JBILOU	Blue	Beauport	XX		10	1	10	2
2	Rima BOURIHANE	Brown	Métropolitain	10	XX	10	2	20	1
3	Rayne IRVING	Brown	Asahi			XX	0	0	3

Pool A

Match	White/Blanc			Blue/Bleu	Res/Rés	Tim/Tmp	Code
D-55	Camilia JBILOU	1	2	Rima BOURIHANE	0 - 10	0:11	IPO
D-70	Camilia JBILOU	1	3	Rayne IRVING	10 - 0	1:53	WIP
D-81	Rima BOURIHANE	2	3	Rayne IRVING	10 - 0	0:47	WIP

Competitors/Compétiteurs B

#	Name/Nom	Grade	Club	4	5	6	W/G	Pts	Pos
4	Juniper WONG	Brown	Action & Reaction	XX	10		1	10	2
5	Kolbi FENRICK	Shodan	Moose Jaw		XX		0	0	3
6	Inara BARDAI	Brown	Tritton	10	10	XX	2	20	1

Pool B

Match	White/Blanc			Blue/Bleu	Res/Rés	Tim/Tmp	Code
D-56	Juniper WONG	4	5	Kolbi FENRICK	10 - 0	0:30	IPO
D-71	Juniper WONG	4	6	Inara BARDAI	0 - 10	1:50	IPO
D-82	Kolbi FENRICK	5	6	Inara BARDAI	0 - 10	1:32	IPO

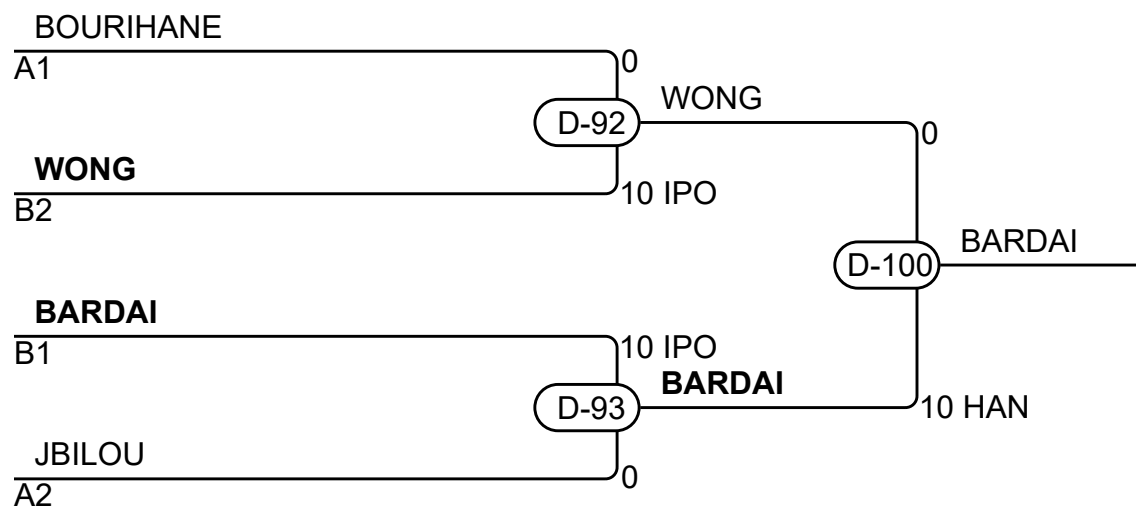

Results/Résultats

Pos	Name/Nom
1	Inara BARDAI, Tritton
2	Juniper WONG, Action & Reaction
3	Rima BOURIHANE, Métropolitain
3	Camilia JBILOU, Beauport

U21 Female -63kg

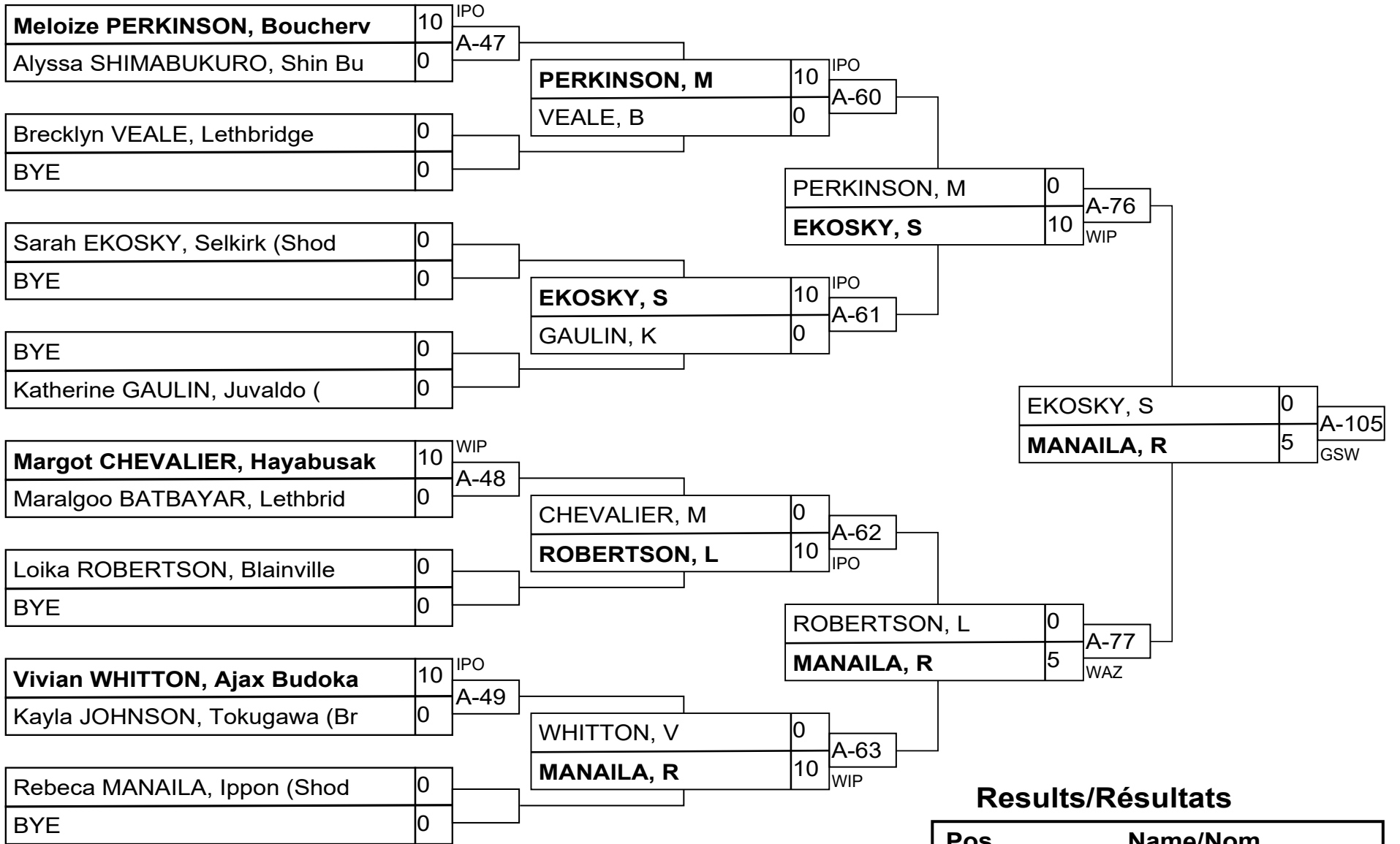

Results/Résultats

Pos	Name/Nom
1	Rebeca MANAILA, Ippon (S)
2	Sarah EKOSKY, Selkirk (S)
3	Margot CHEVALIER, Hayabu
3	Loika ROBERTSON, Blainvi

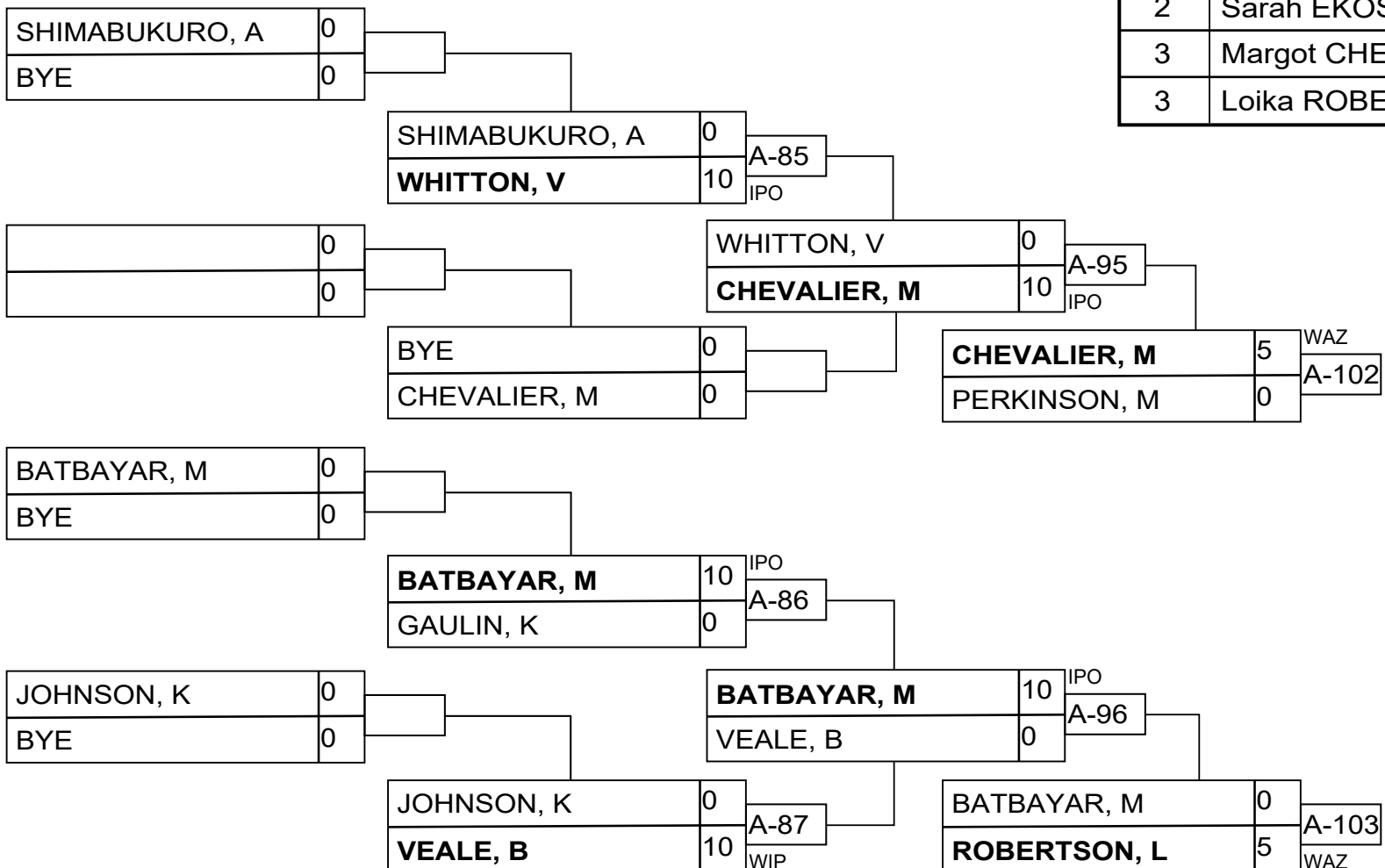

U21 Female -70kg

Competitors/Compétiteurs

#	Name/Nom	Grade	Club	1	2	3	4	5	W/G	Pts	Pos
1	Savannah MACDONALD	Brown	Huntsville	XX			10		1	10	4
2	Elizabeth COSSITT	Brown	Kodokwai	10	XX	10	10		3	30	2
3	Julie PIN	Shodan	AS JUDO LAGNIEU	10		XX	10		2	20	3
4	Sabrina BRAGINSKY	Brown	Challenge				XX		0	0	5
5	Kiera BURT	Shodan	Upper Canada	10	10	10	10	XX	4	40	1

Matches/Matches

Match	White/Blanc			Blue/Bleu	Res/Rés	Tim/Tmp	Code
B-46	Sabrina BRAGINSKY	4	5	Kiera BURT	0 - 10	0:18	IPO
B-47	Savannah MACDONALD	1	2	Elizabeth COSSITT	0 - 10	0:33	IPO
B-53	Julie PIN	3	4	Sabrina BRAGINSKY	10 - 0	0:00	FUS
B-54	Savannah MACDONALD	1	5	Kiera BURT	0 - 10	0:56	WIP
B-62	Elizabeth COSSITT	2	3	Julie PIN	10 - 0	1:16	WIP
B-63	Savannah MACDONALD	1	4	Sabrina BRAGINSKY	10 - 0	1:42	IPO
B-77	Julie PIN	3	5	Kiera BURT	0 - 10	0:33	IPO
B-78	Elizabeth COSSITT	2	4	Sabrina BRAGINSKY	10 - 0	0:30	IPO
B-88	Savannah MACDONALD	1	3	Julie PIN	0 - 10	0:21	IPO
B-89	Elizabeth COSSITT	2	5	Kiera BURT	0 - 10	1:57	IPO

Results/Résultats

Pos	Name/Nom
1	Kiera BURT, Upper Canada
2	Elizabeth COSSITT, Kodokwai
3	Julie PIN, AS JUDO LAGNIEU
4	Savannah MACDONALD, Huntsville

U21 Female -78kg

Competitors/Compétiteurs

#	Name/Nom	Grade	Club	1	W/G	Pts	Pos
1	Zen MINEQUE	Brown	Trent Univ Judo Club	XX	0	0	1

Matches/Matches

Match	White/Blanc	Blue/Bleu	Res/Rés	Tim/Tmp	Code
-------	-------------	-----------	---------	---------	------

Results/Résultats

Pos	Name/Nom

U21 Female +78kg

Competitors/Compétiteurs

#	Name/Nom	Grade	Club	1	2	3	4	W/G	Pts	Pos
1	Frederique LAVIGNE	Brown	Métropolitain	XX	5	10	10	3	25	1
2	Marianna KARAS	Shodan	Kodokwai		XX	10	10	2	20	2
3	Alisa KOFMAN	Brown	Challenge			XX		0	0	4
4	Frederique FOREST	Brown	Kiseki			10	XX	1	10	3

Matches/Matches

Match	White/Blanc			Blue/Bleu	Res/Rés	Tim/Tmp	Code
A-78	Frederique LAVIGNE	1	2	Marianna KARAS	5 - 0	4:00	WAZ
A-79	Alisa KOFMAN	3	4	Frederique FOREST	0 - 10	1:50	IPO
A-88	Frederique LAVIGNE	1	3	Alisa KOFMAN	10 - 0	0:23	IPO
A-89	Marianna KARAS	2	4	Frederique FOREST	10 - 0	0:50	IPO
A-97	Frederique LAVIGNE	1	4	Frederique FOREST	10 - 0	1:55	IPO
A-98	Marianna KARAS	2	3	Alisa KOFMAN	10 - 0	0:26	IPO

Results/Résultats

Pos	Name/Nom
1	Frederique LAVIGNE, Métropolitain
2	Marianna KARAS, Kodokwai
3	Frederique FOREST, Kiseki

U21 Male -100kg

Competitors/Compétiteurs A

#	Name/Nom	Grade	Club	1	2	3	W/G	Pts	Pos
1	Ethan ELLIS	Brown	Formokan	XX			0	0	3
2	Nick LUCHKIN	Brown	Challenge	10	XX	10	2	20	1
3	Jamal KANE	Brown	Olympique	10		XX	1	10	2

Pool A

Match	White/Blanc	Blue/Bleu	Res/Rés	Tim/Tmp	Code
C-54	Ethan ELLIS 1 2	Nick LUCHKIN	0 - 10	0:10	IPO
C-65	Ethan ELLIS 1 3	Jamal KANE	0 - 10	0:00	FUS
C-79	Nick LUCHKIN 2 3	Jamal KANE	10 - 0	3:14	KIK

Competitors/Compétiteurs B

#	Name/Nom	Grade	Club	4	5	6	W/G	Pts	Pos
4	Abel VELASQUEZ KASAP	Brown	Police Jr.	XX		10	1	10	2
5	Ethan GAUDET	Brown	Toshidokan	10	XX	10	2	20	1
6	Bearett ALEXANDER	Brown	Judokaa			XX	0	0	3

Pool B

Match	White/Blanc	Blue/Bleu	Res/Rés	Tim/Tmp	Code
C-55	Abel VELASQUEZ KASAP 4 5	Ethan GAUDET	0 - 10	0:28	IPO
C-66	Abel VELASQUEZ KASAP 4 6	Bearett ALEXANDER	10 - 0	0:20	IPO
C-80	Ethan GAUDET 5 6	Bearett ALEXANDER	10 - 0	0:28	IPO

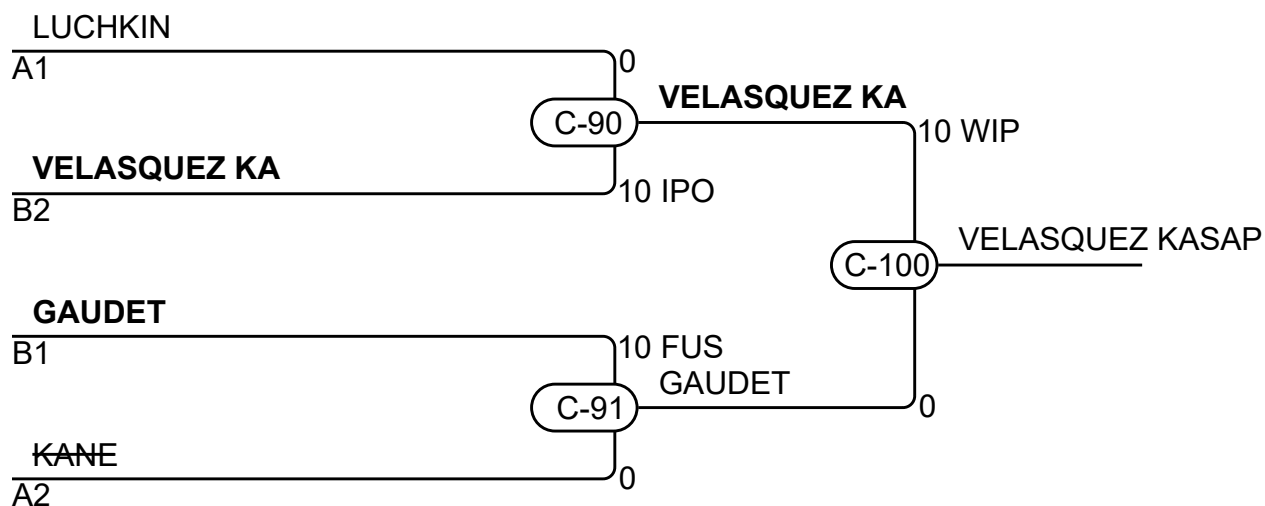

Results/Résultats

Pos	Name/Nom
1	Abel VELASQUEZ KASAP, Police Jr.
2	Ethan GAUDET, Toshidokan
3	Nick LUCHKIN, Challenge
3	Jamal KANE, Olympique

U21 Male -60kg

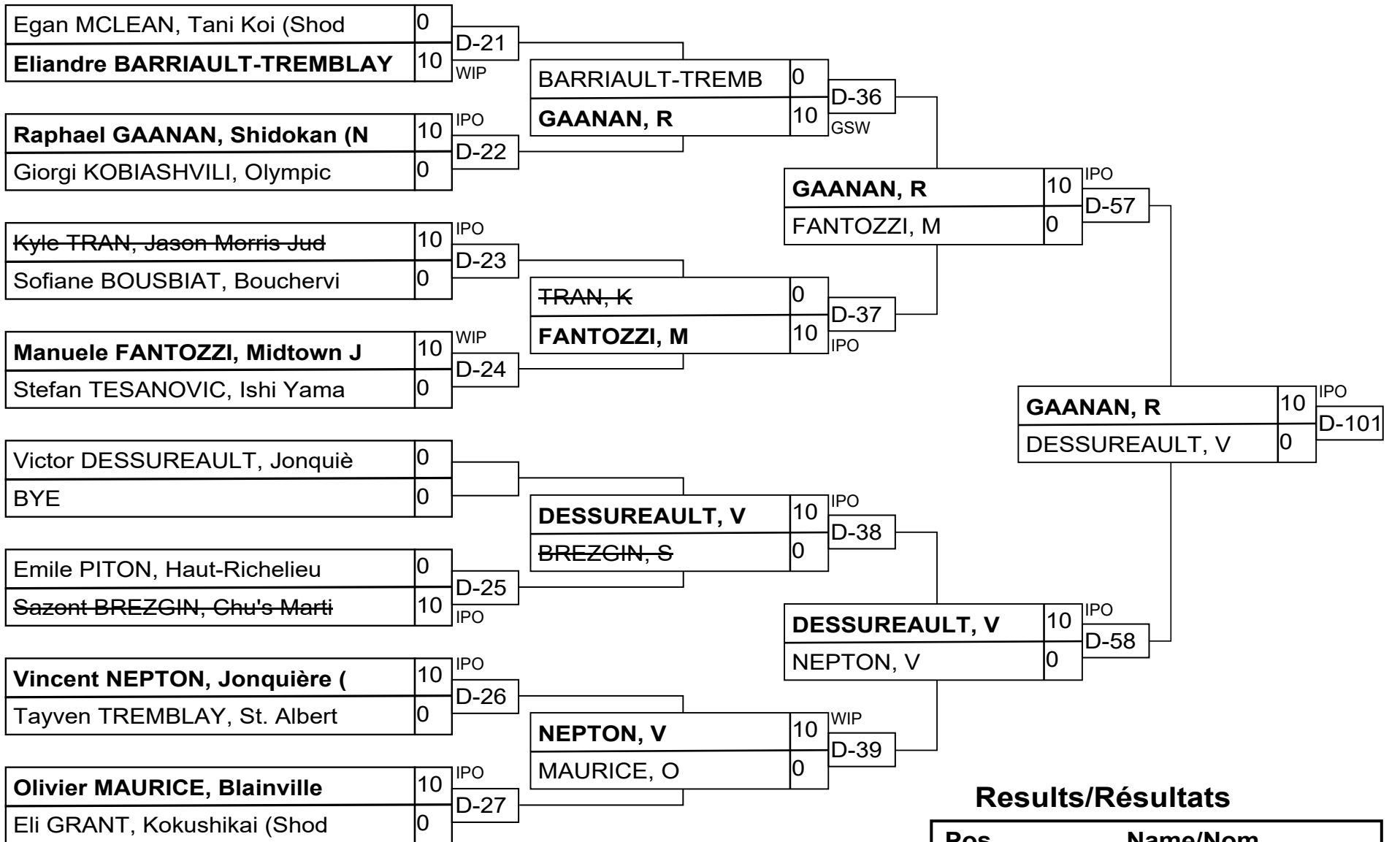

Results/Résultats

Pos	Name/Nom
1	Raphael GAANAN, Shidokan
2	Victor DESSUREAULT, Jonq
3	Stefan TESANOVIC, Ishi Y
3	Vincent NEPTON, Jonquière

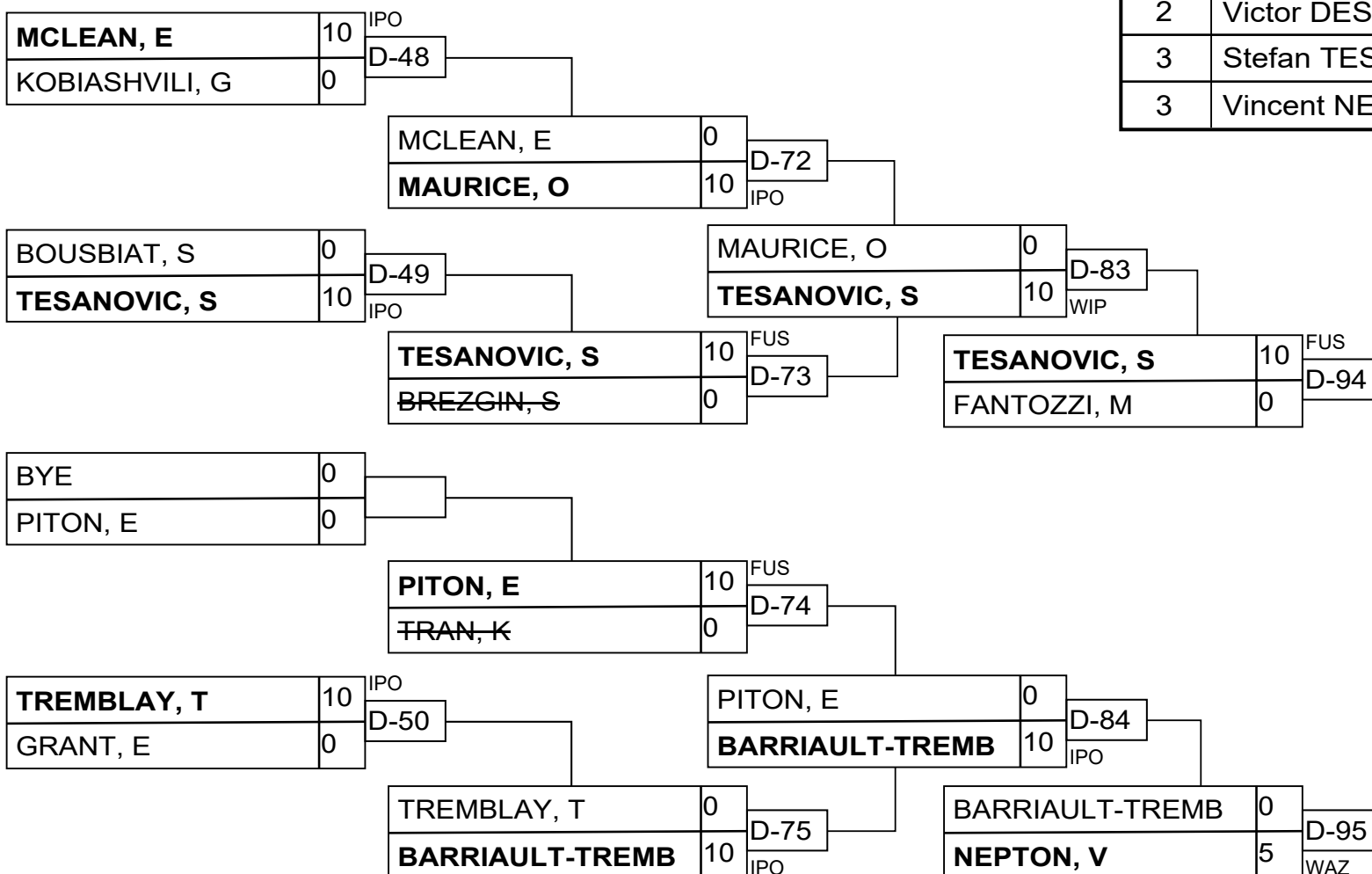

U21 Male -66kg

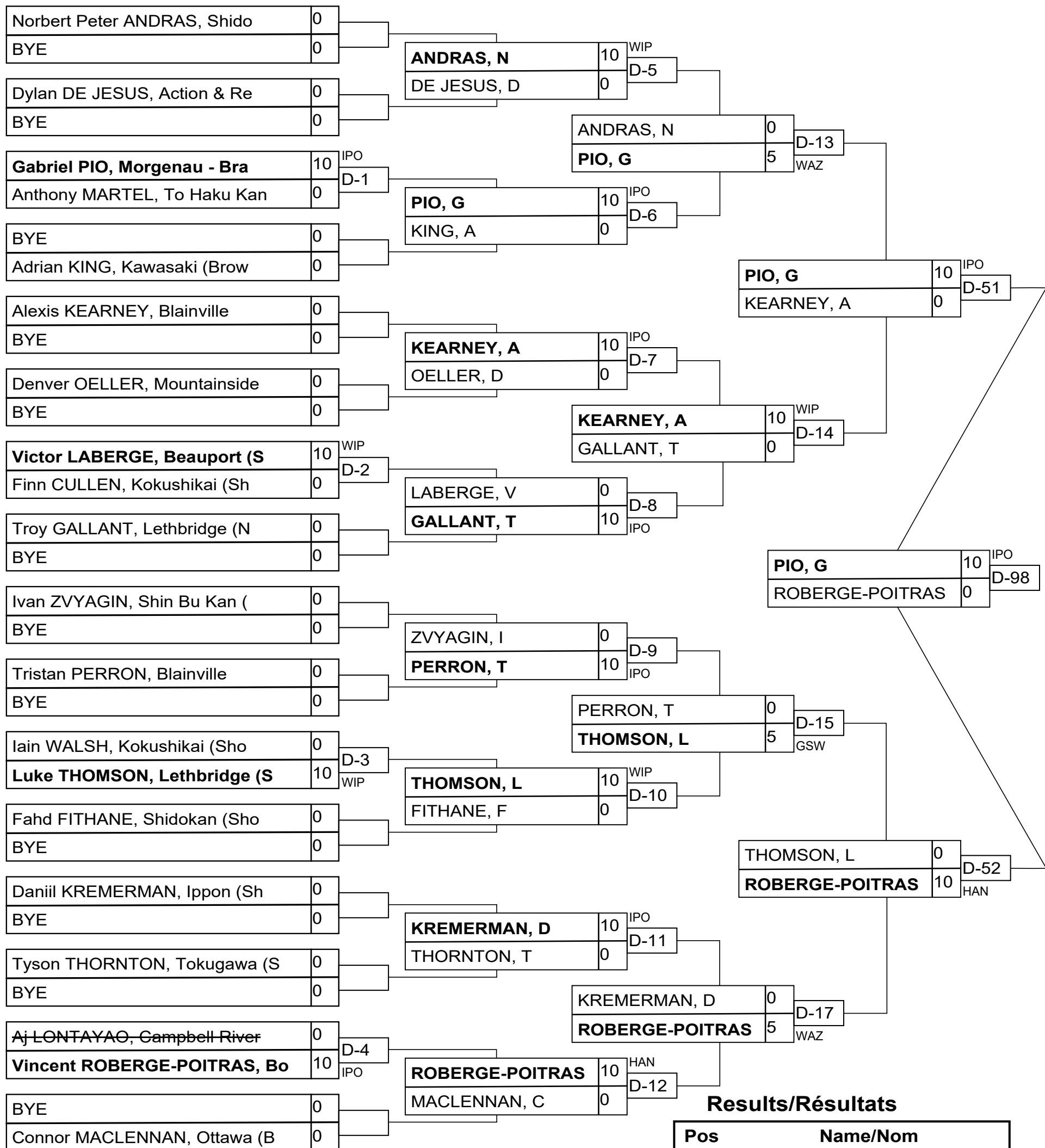

Results/Résultats

Pos	Name/Nom
1	Gabriel PIO, Morgenau -
2	Vincent ROBERGE-POITRAS,
3	Daniil KREMERMANN, Ippon
3	Fahd FITHANE, Shidokan (

U21 Male -66kg

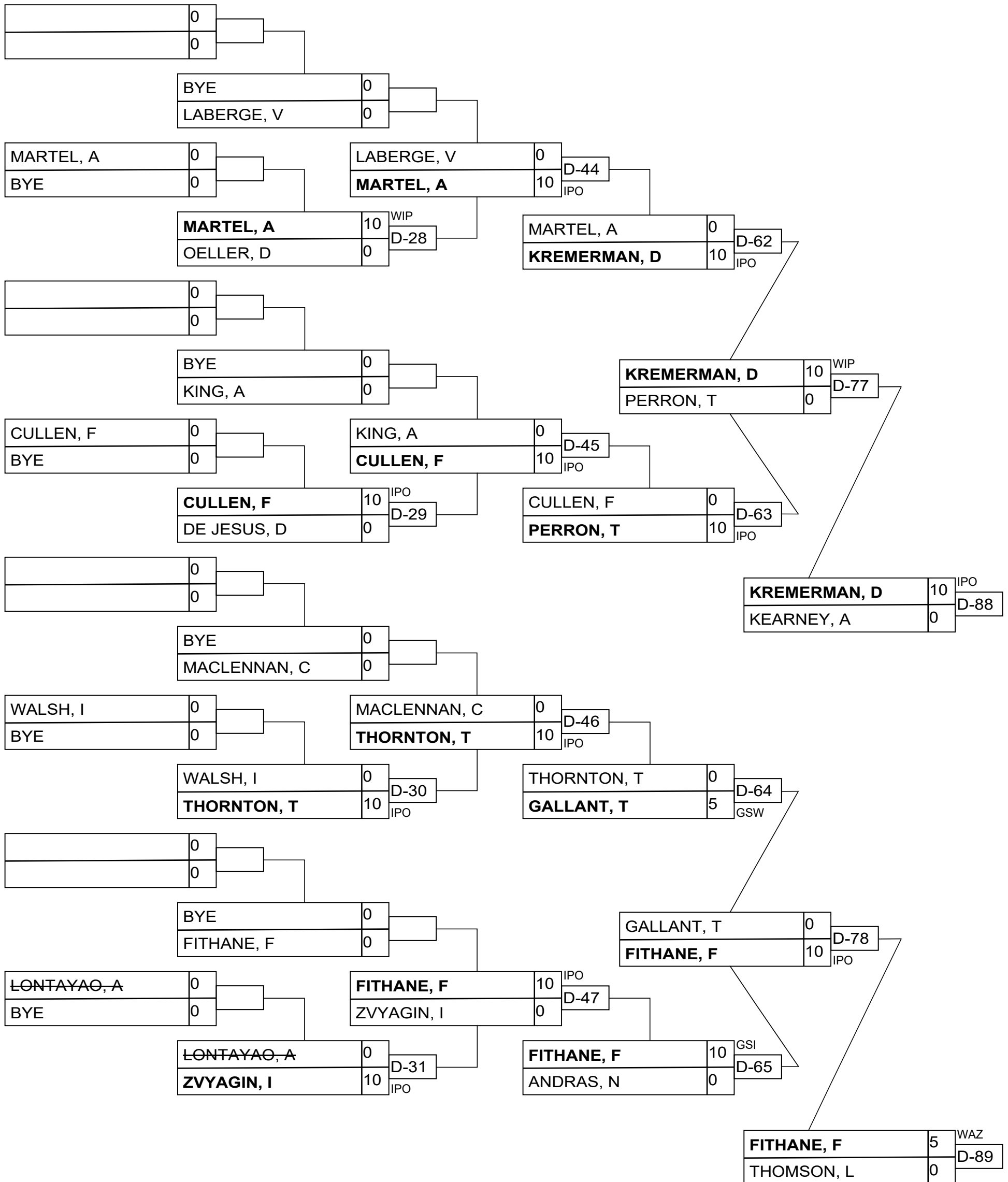

U21 Male -73kg

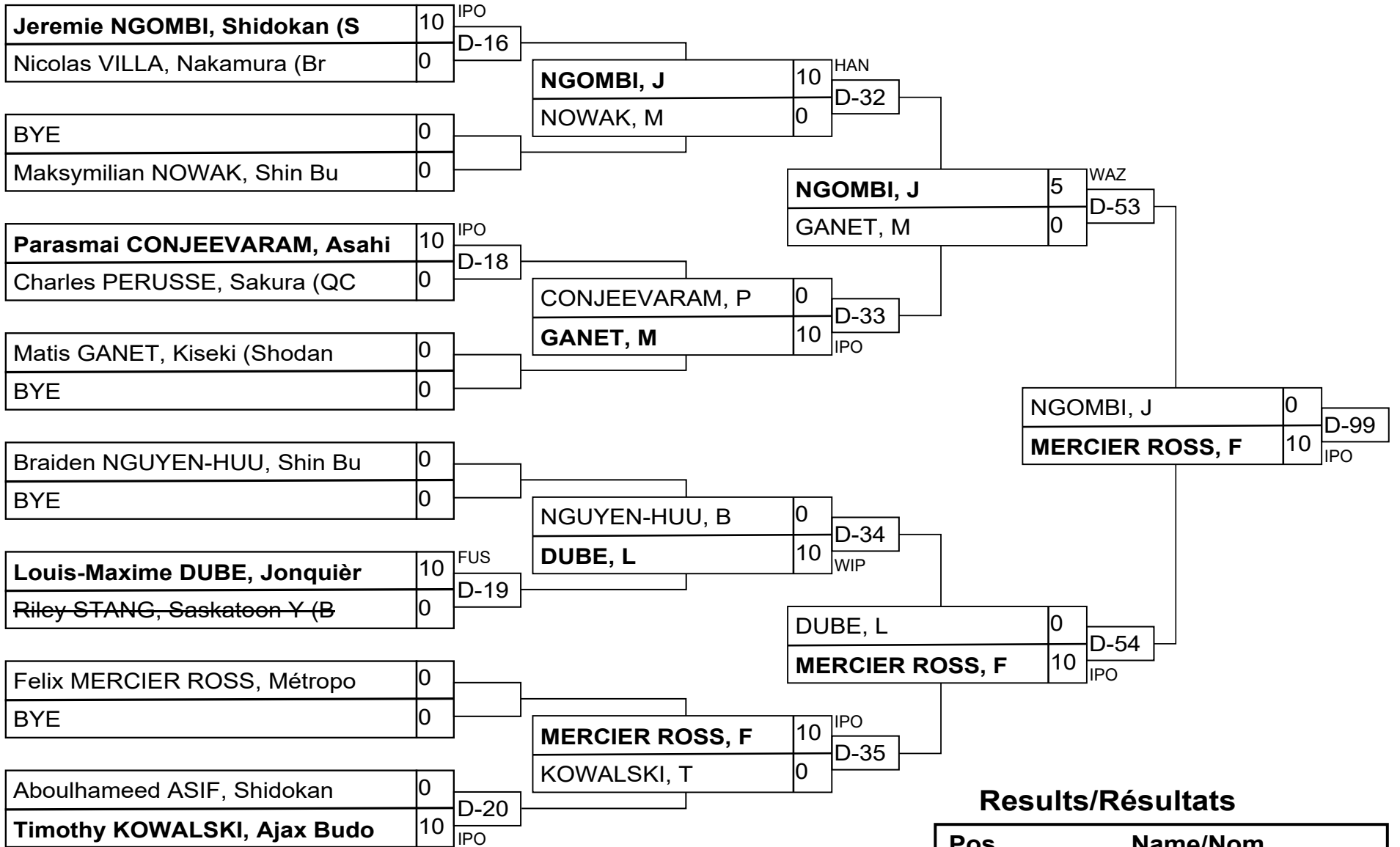

Results/Résultats

Pos	Name/Nom
1	Felix MERCIER ROSS, Métr
2	Jeremie NGOMBI, Shidokan
3	Matis GANET, Kiseki (Sho
3	Maksymilian NOWAK, Shin

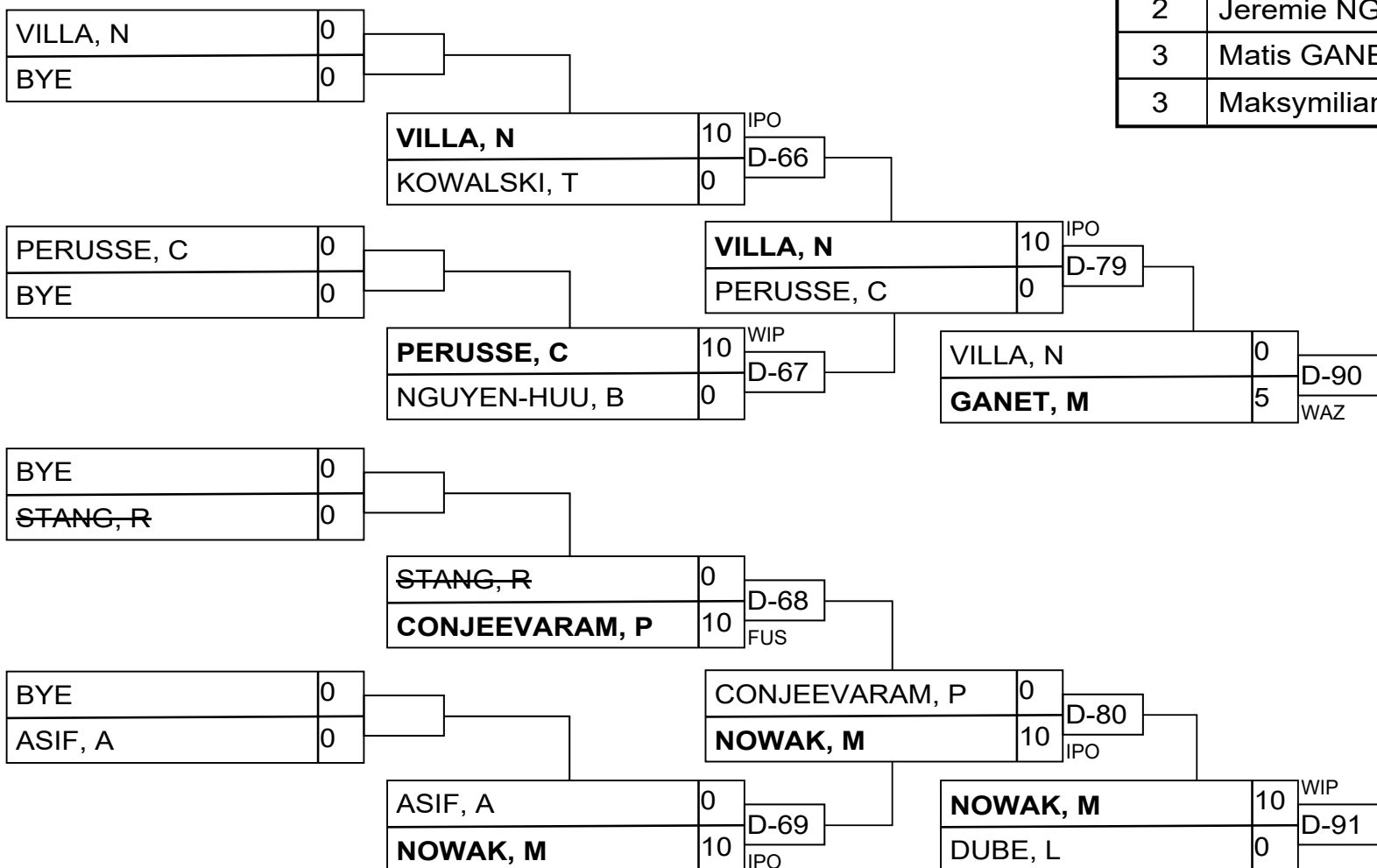

U21 Male -81kg

Habib SAID MOHAMMAD, Kodokw	10	IPO		
Timothy MATHER-SCHOEP, Form	0		E-14	
Laurent QUIEDEVILLE, Seikid	0			
Porter GUY, Hatashita (Shod	10	IPO	E-15	
Binyamin SOLOVEICHIK, Chall	10	KIK	E-16	
Faris Ali KHAN, Fudoshin (B	0			
Garrett PARKER, Barracuda (10	HAN	E-17	
Quezon MINEQUE, Trent Univ	0			
Yuriy SEMENYUK, Métropolita	10	IPO	E-18	
Daniel EKOSKY, Selkirk (Sho	0			
Ethan DEEG, Tokugawa (Brown	0		E-19	
Matthew SERRANO, Ajax Budok	10	WIP		
Arthur KARPUKOV, Ippon (Sho	10	IPO	E-20	
Ivan CHITOV, Judo Kai (Shod	0			
Tyler LANGE, Kokushikai (Sh	0		E-21	
Carter ALTHOUSE, Lethbridge	10	IPO		

MATHER-SCHOEP,	0		E-37	
QUIEDEVILLE, L	10	IPO		
QUIEDEVILLE, L	0		E-64	
ALTHOUSE, C	10	IPO		
KHAN, F	10	IPO	E-38	
MINEQUE, Q	0			
ALTHOUSE, C	10	IPO	E-80	
SERRANO, M	0			
KHAN, F	0		E-65	
SERRANO, M	10	IPO		
ALTHOUSE, C	0		E-91	WAZ
SAID MOHAMMAD,	5			
EKOSKY, D	10	IPO	E-39	
DEEG, E	0			
EKOSKY, D	10	IPO	E-66	
PARKER, G	0			
CHITOV, I	10	IPO	E-40	
LANGE, T	0			
EKOSKY, D	10	WIP	E-81	
GUY, P	0			
CHITOV, I	0		E-67	
GUY, P	10	IPO		
EKOSKY, D	0		E-92	
SEMENYUK, Y	10	IPO		

Results/Résultats

Pos	Name/Nom
1	Binyamin SOLOVEICHIK, Ch
2	Arthur KARPUKOV, Ippon (
3	Habib SAID MOHAMMAD, Kod
3	Yuriy SEMENYUK, Métropol

U21 Male -90kg

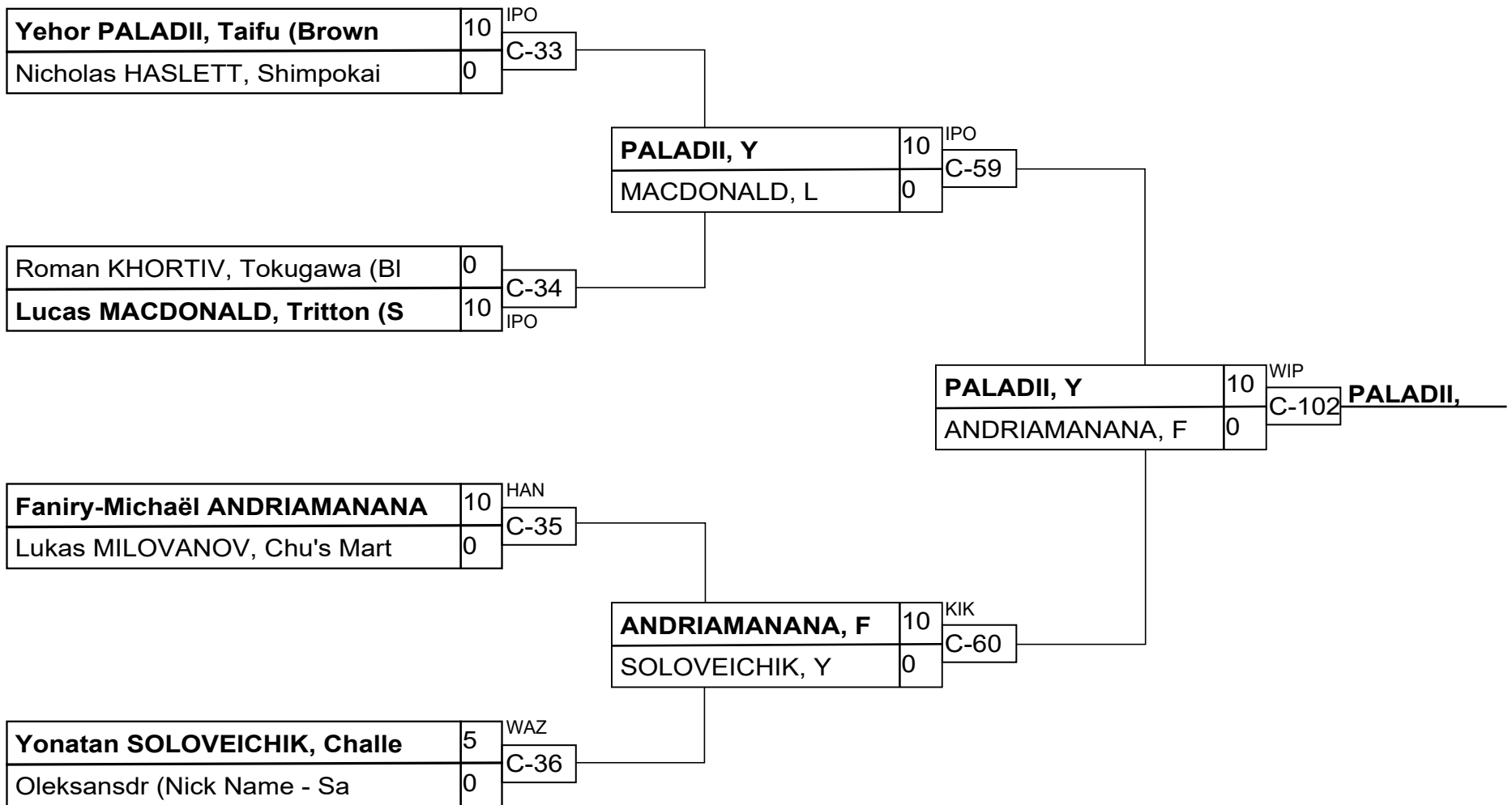

Results/Résultats

Pos	Name/Nom
1	Yehor PALADII, Taifu (Br
2	Faniry-Michaël ANDRIAMAN
3	Lucas MACDONALD, Tritton
3	Nicholas HASLETT, Shimpo

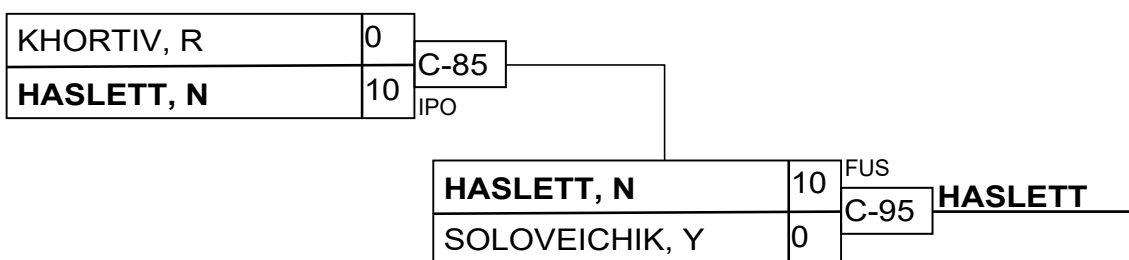
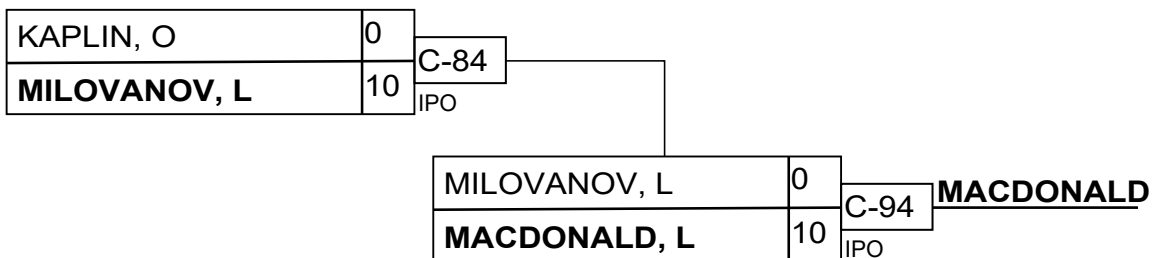

U21 Male +100kg

Competitors/Compétiteurs

#	Name/Nom	Grade	Club	1	2	3	W/G	Pts	Pos
1	Jean Félix ILUNGA	Blue	Ottawa	XX			0	0	3
2	Lucas ALLEN	Brown	Huntsville	10	XX		1	10	2
3	Rayan BÉLAL	Brown	Olympique	10	10	XX	2	20	1

Matches/Matches

Match	White/Blanc			Blue/Bleu	Res/Rés	Tim/Tmp	Code
C-58	Jean Félix ILUNGA	1	2	Lucas ALLEN	0 - 10	1:51	WIP
C-70	Jean Félix ILUNGA	1	3	Rayan BÉLAL	0 - 10	1:10	IPO
C-83	Lucas ALLEN	2	3	Rayan BÉLAL	0 - 10	0:14	IPO

Results/Résultats

Pos	Name/Nom
1	Rayan BÉLAL, Olympique
2	Lucas ALLEN, Huntsville